















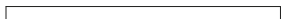





Stuklijst / Liste des pièces / Bill of material

	Ref.	Index	#
	↓	↓	↓
	G	WW028x149-PRF-000-0-3800	14
	J	WW016x095-PLA-000-0-2950	45
	<p>ALTERNATIEF: Het kan productiematig zijn dat er andere planchettes J in de verpakking zitten. De referentie is dan WW016x120-PLA-000-0-2950 => aantal 36 stuks</p> <p>ALTERNATIVE: Il peut être lié à la production que d'autres planchettes J soient incluses dans l'emballage. La référence est alors WW016x120-PLA-000-0-2950 => # 36 pièces</p> <p> ALTERNATIVE: It may be production-related that other planchettes J are included in the package. The reference is then WW016x120-PLA-000-0-2950 => # 36 pieces</p> <p>ALTERNATIVE: Es kann produktionsbedingt sein, dass andere Planchetten J im Paket enthalten sind. Die Referenz ist dann WW016x120-PLA-000-0-2950 => # 36 Stück</p>		
	H	WW028x040-4FA-000-0-2100	3
	H1	WW016x145-4R8-000-0-1950	2
	K	WW040x145-4FA-000-0-3945	5
	K1	WW040x145-4FA-000-0-2730	1
	M	WW016x145-4R8-000-0-4012	1
	M1	WW016x095-4FA-000-0-4000	4
	M2	WW028x040-4FA-000-0-1750	2
	R	S617  3.5 x 35 #20	3
	R1	S625  5.0 x 70 #20	1
	R2	S637  2.8 x 50 #100	2
	R3	S6810 M8 x 80	8
	S	S5515	2
	T	RW088x088-4R8-000-1-2100	2
	U	S6747 146	12

R = 8
R1 = 8

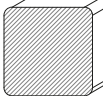

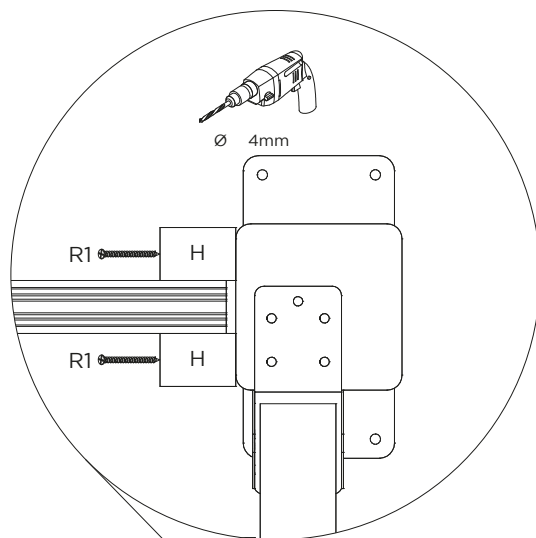
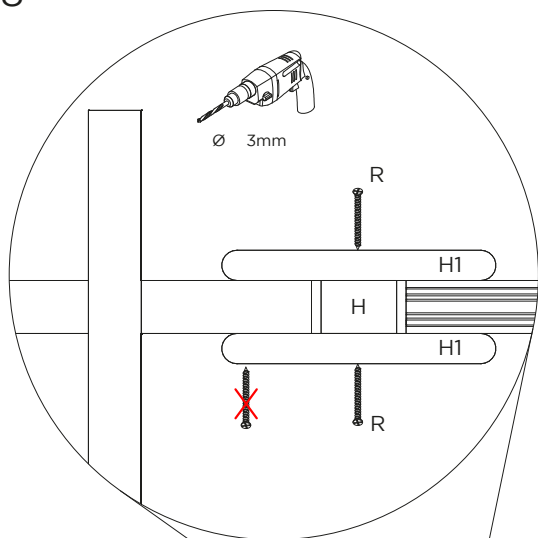
Opening werking hout !!!!
Ouverture dilation bois !!!!
Opening working wood !!!!

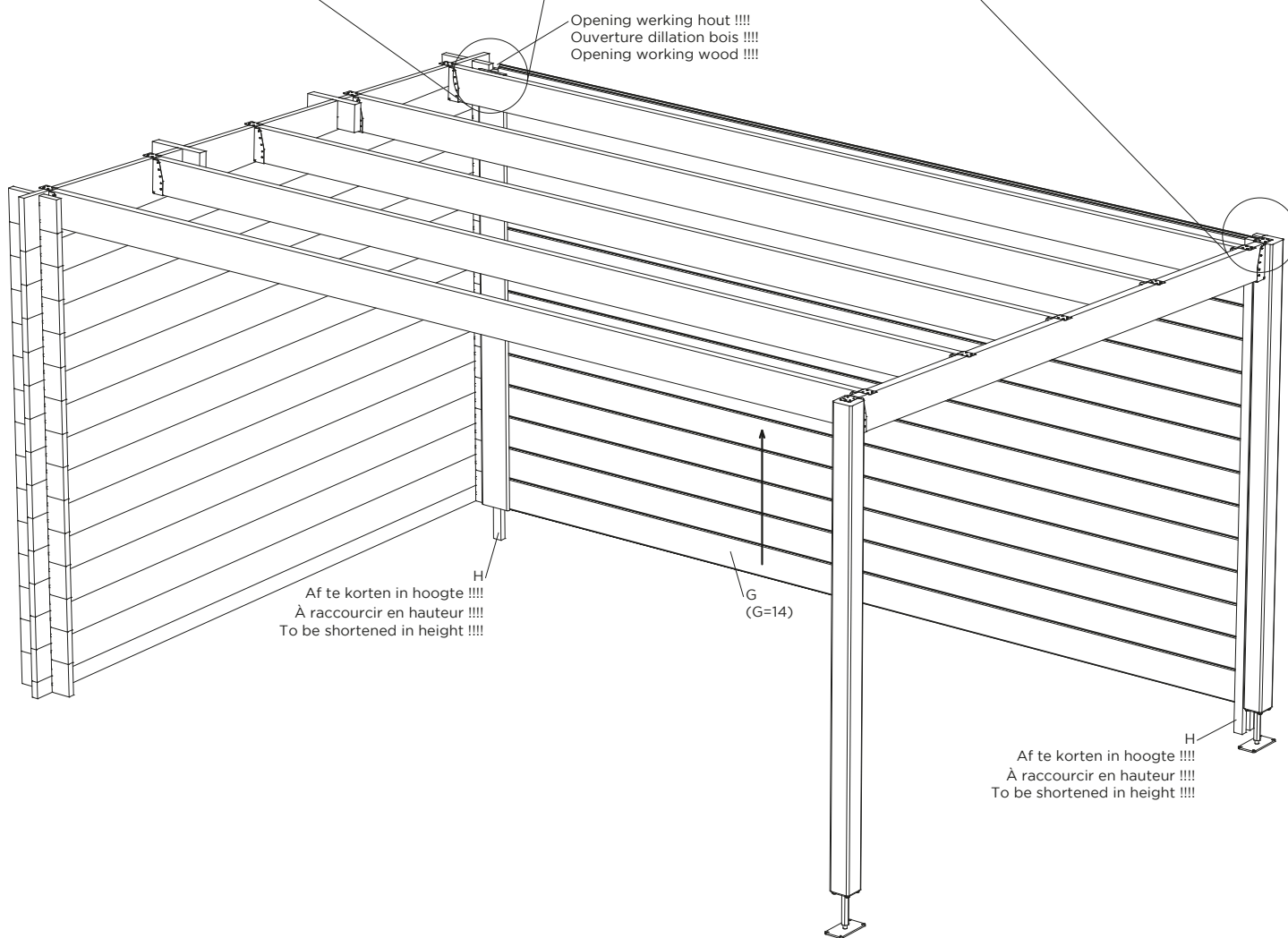

Af te korten in hoogte !!!!
À raccourcir en hauteur !!!!
To be shortened in height !!!!

Af te korten in hoogte !!!!
À raccourcir en hauteur !!!!
To be shortened in height !!!!

J = 45 of/ou/or/oder 36
2.8 x 50 # 180

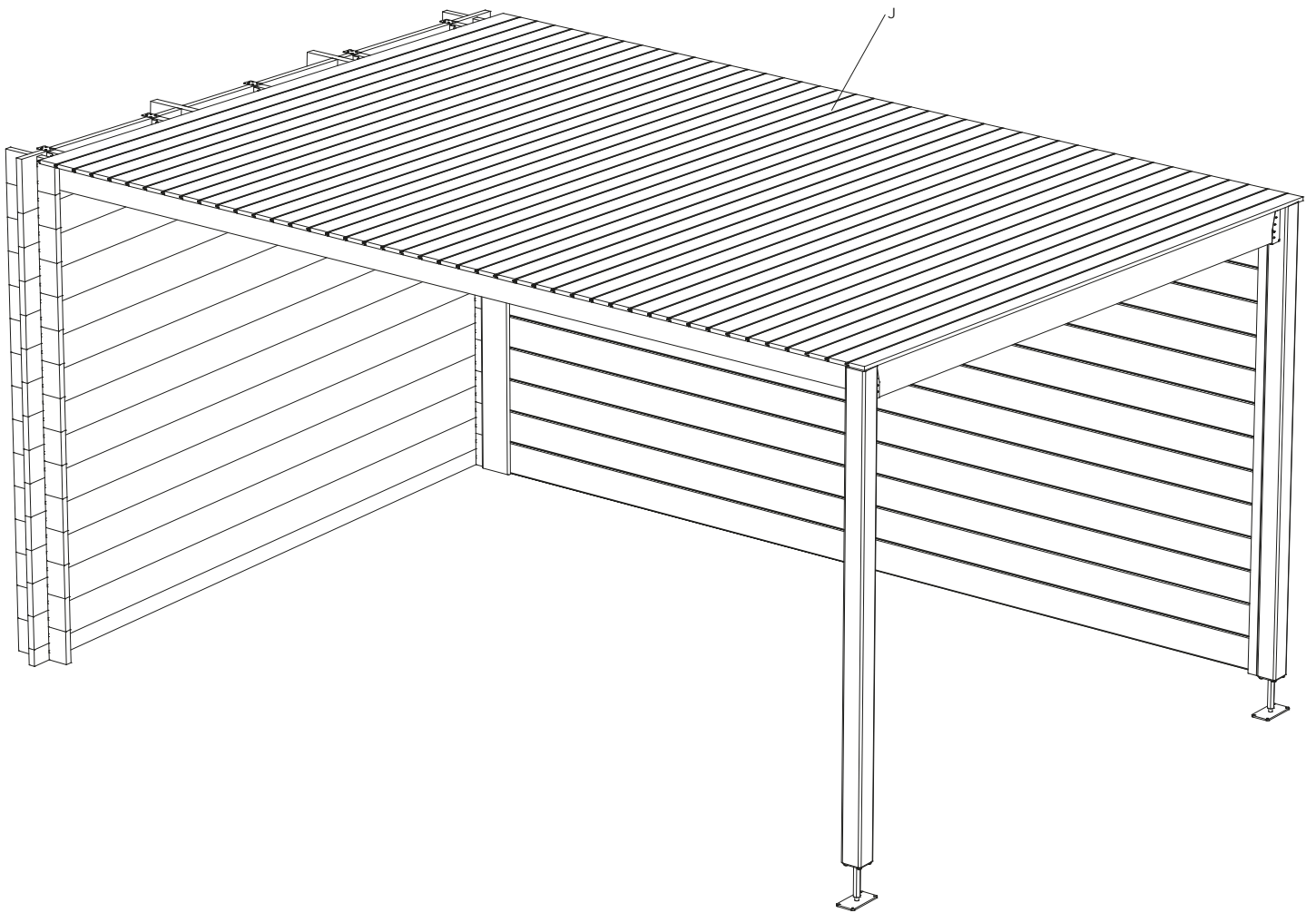
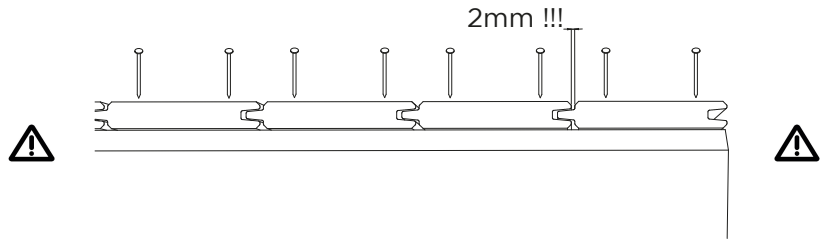

M = 1
2.8 x 50 # 20

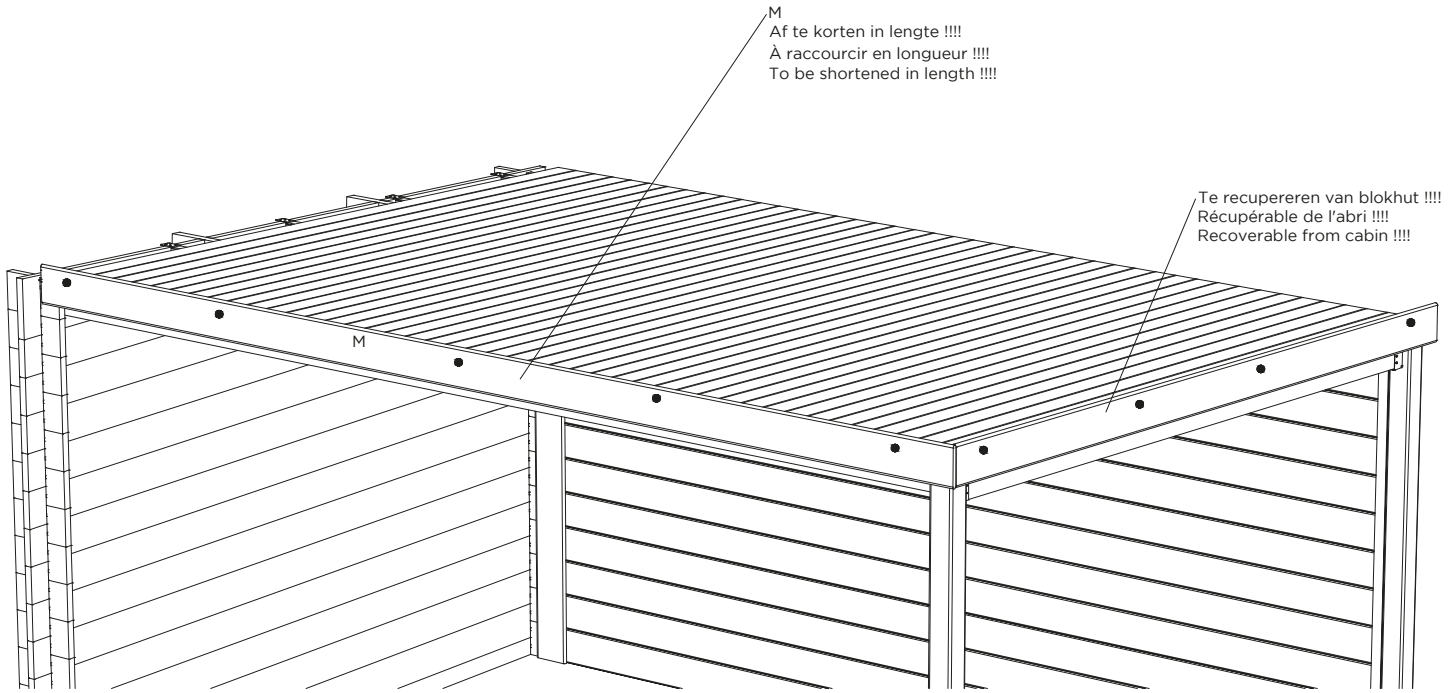
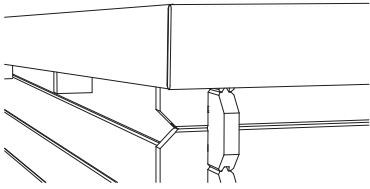

M1 = 4
M2 = 1
R = 28

