













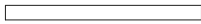
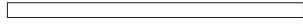
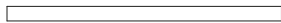
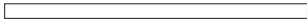

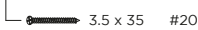

# Stuklijst / Liste des pièces / Bill of material

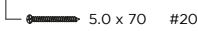
	Ref.	Index	#
	↓	↓	↓
	G	WW028x149-PRF-000-0-2800	14
	J	WW016x095-PLA-000-0-2950	35
	<p><b>ALTERNATIEF:</b> Het kan productiematig zijn dat er andere planchettes J in de verpakking zitten. De referentie is dan WW016x120-PLA-000-0-2950 =&gt; aantal 28 stuks</p> <p><b>ALTERNATIVE:</b> Il peut être lié à la production que d'autres planchettes J soient incluses dans l'emballage. La référence est alors WW016x120-PLA-000-0-2950 =&gt; # 28 pièces</p> <p> <b>ALTERNATIVE:</b> It may be production-related that other planchettes J are included in the package. The reference is then WW016x120-PLA-000-0-2950 =&gt; # 28 pieces</p> <p><b>ALTERNATIVE:</b> Es kann produktionsbedingt sein, dass andere Planchetten J im Paket enthalten sind. Die Referenz ist dann WW016x120-PLA-000-0-2950 =&gt; # 28 Stück</p>		
	H	WW028x040-4FA-000-0-2100	3
	H1	WW016x145-4R8-000-0-1950	2
	K	WW040x145-4FA-000-0-2945	5
	K1	WW040x145-4FA-000-0-2730	1
	M	WW016x145-4R8-000-0-3012	1
	M1	WW016x095-4FA-000-0-3100	4
	M2	WW028x040-4FA-000-0-1750	1
	R	S617  3.5 x 35 #20	3
	R1	S625  5.0 x 70 #20	1
	R2	S637  2.8 x 50 #100	2
	R3	S6810 M8 x 80	8
	S	S5515	2
	T	RW088x088-4R8-000-1-2100	2
	U	S6747 146	12

- K = 5
- K1 = 1
- R = 24
- R1 = 12
- R3 = 8
- S = 2
- T = 2
- U = 12

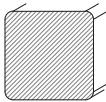

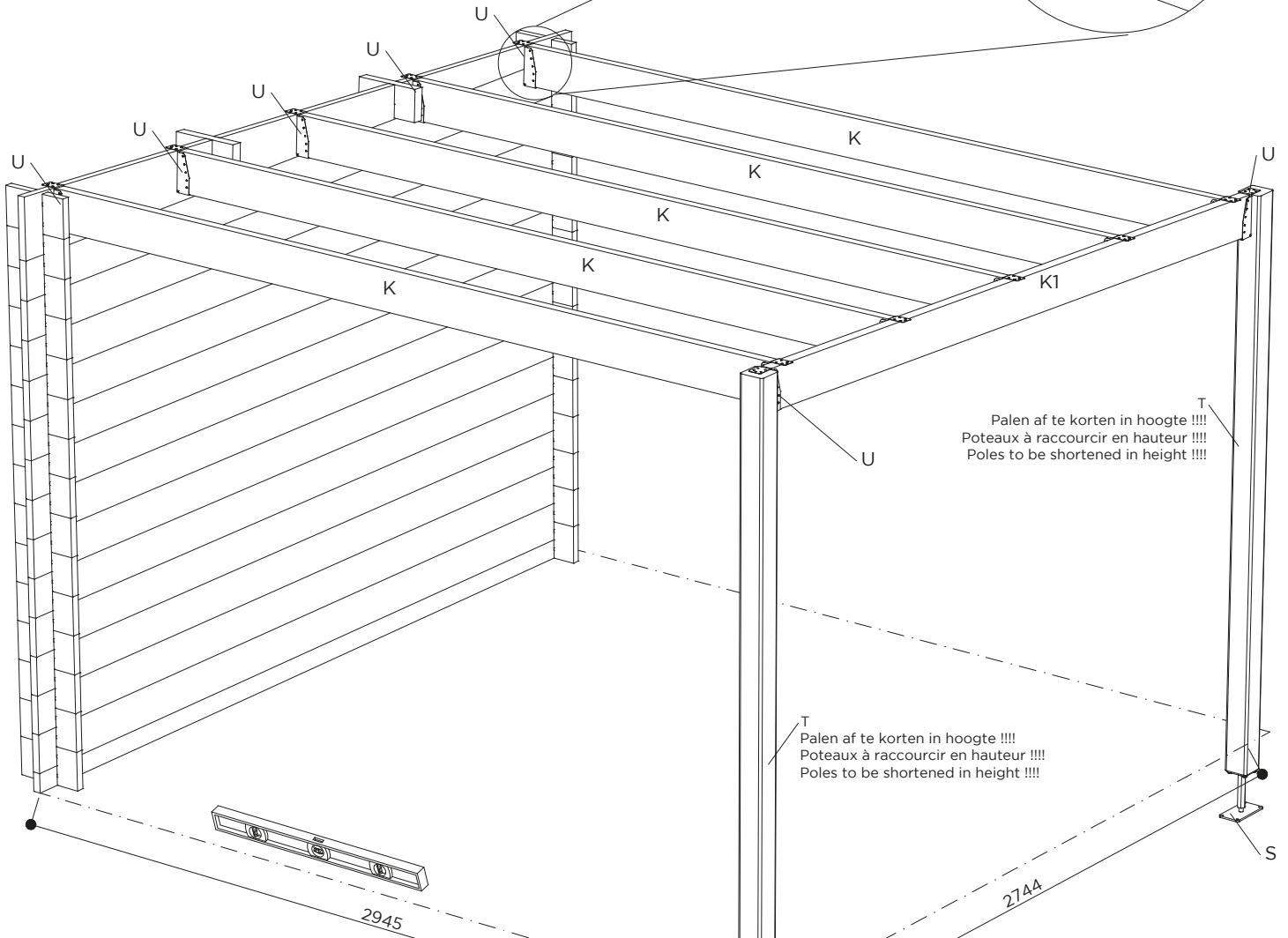
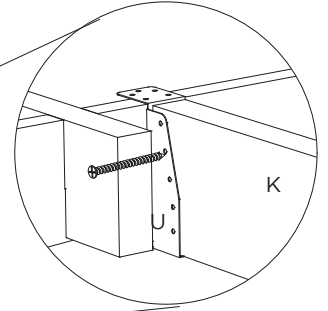
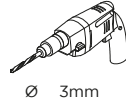
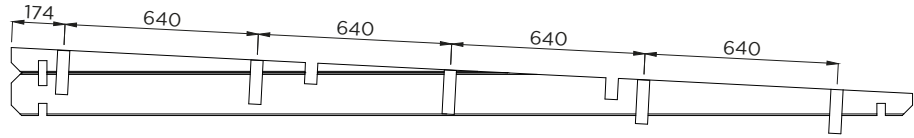
Palen af te korten in hoogte !!!!  
 Poteaux à raccourcir en hauteur !!!!  
 Poles to be shortened in height !!!!

T  
 Palen af te korten in hoogte !!!!  
 Poteaux à raccourcir en hauteur !!!!  
 Poles to be shortened in height !!!!

Afmeting tussen de palen!  
 Dimensions entre les poteaux!  
 Dimensions between the posts!

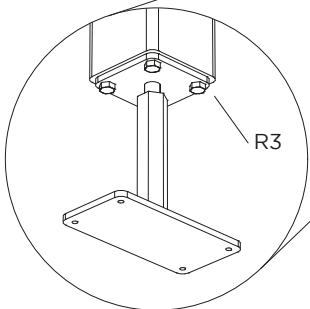

R = 8  
R1 = 8

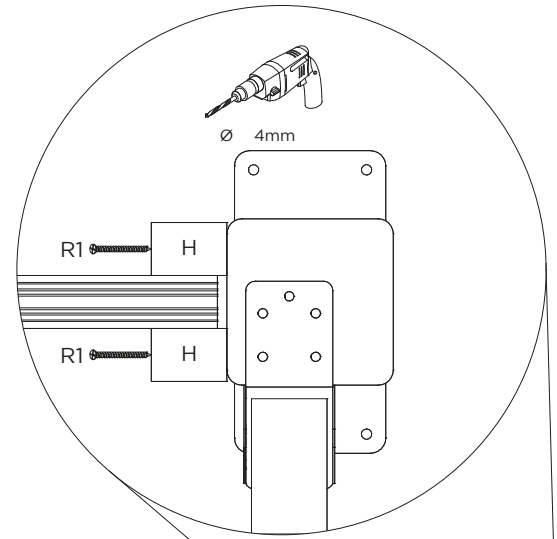
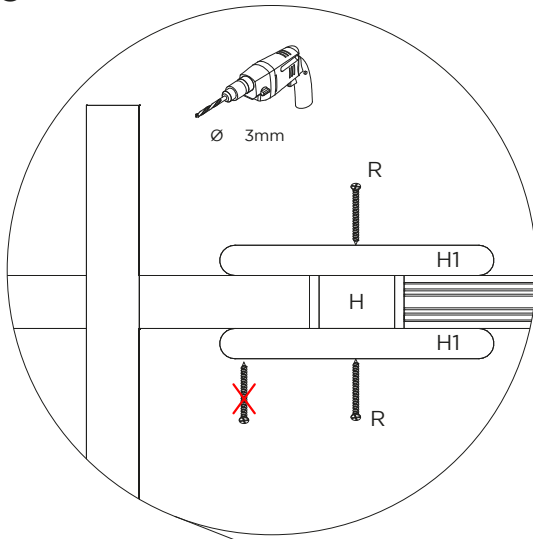

Opening werking hout !!!!  
Ouverture dillation bois !!!!  
Opening working wood !!!!

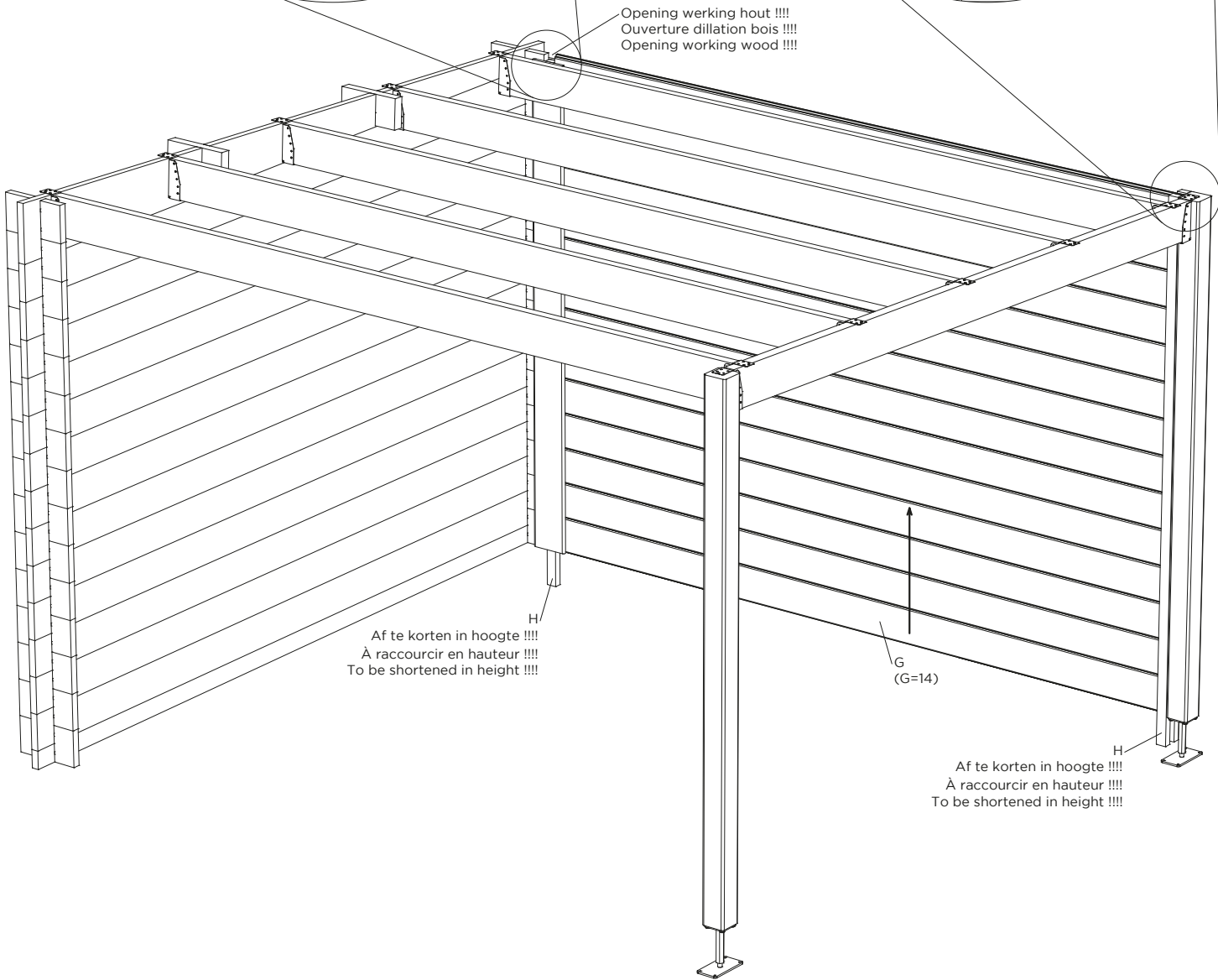

H  
Af te korten in hoogte !!!!  
À raccourcir en hauteur !!!!  
To be shortened in height !!!!

H  
Af te korten in hoogte !!!!  
À raccourcir en hauteur !!!!  
To be shortened in height !!!!

J = 35 of/ou/or/oder 28  
2.8 x 50 # 92

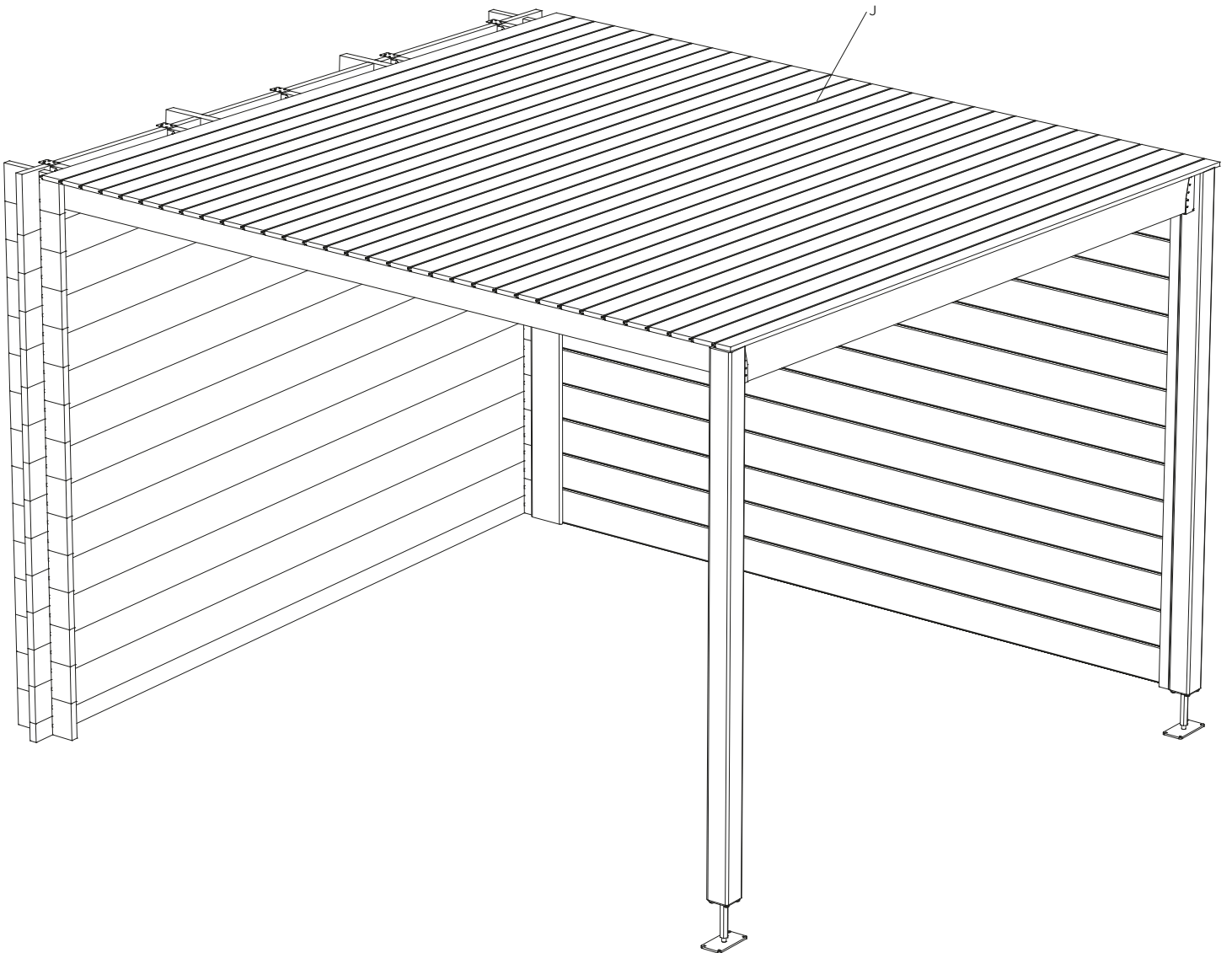
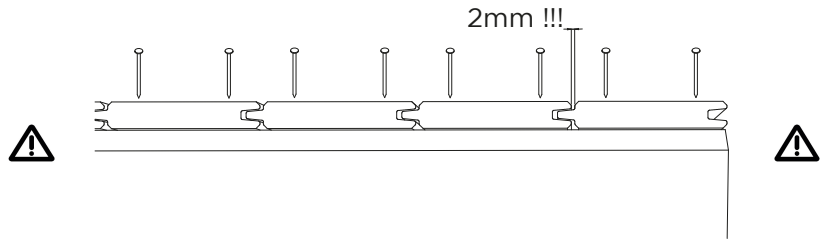

M = 1  
2.8 x 50 # 20

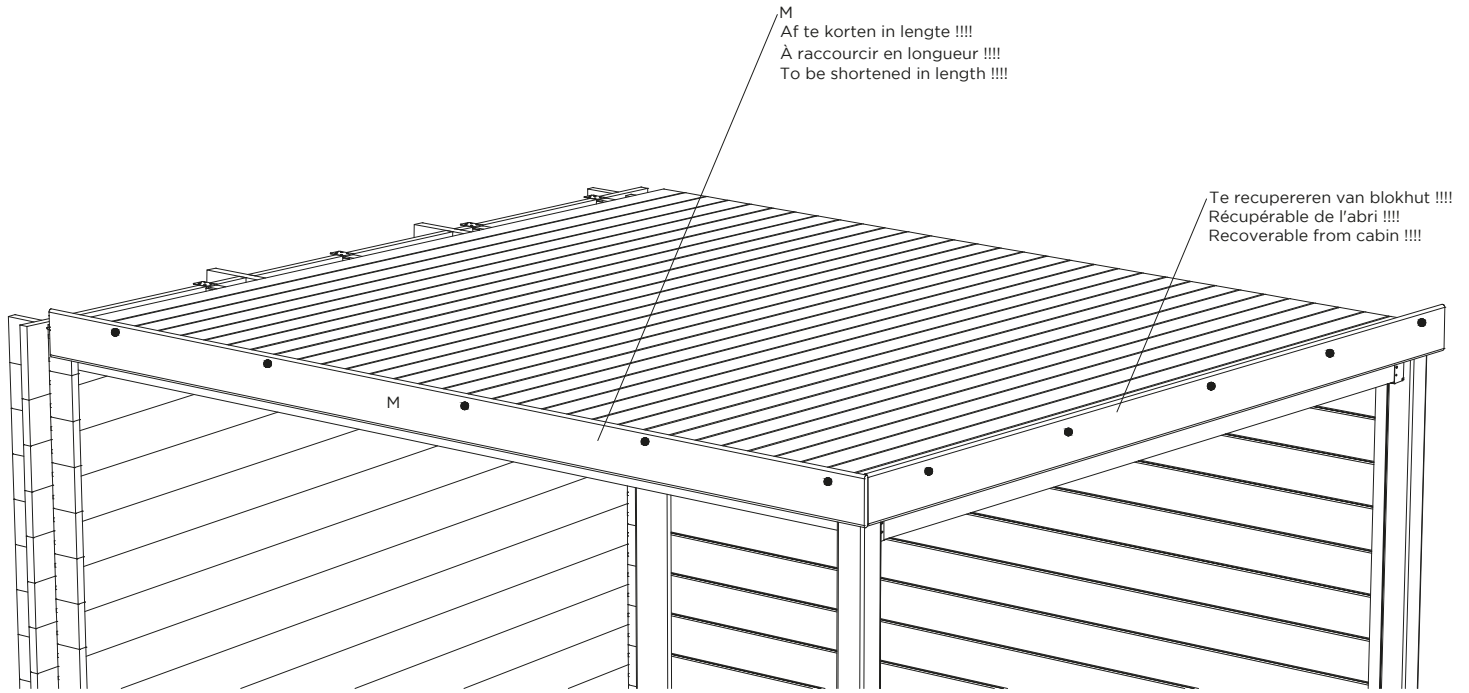
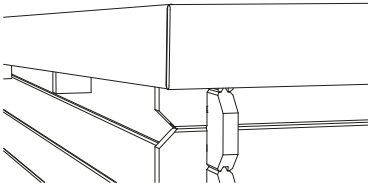

M1 = 4  
M2 = 1  
R = 28

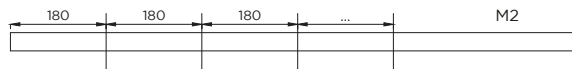
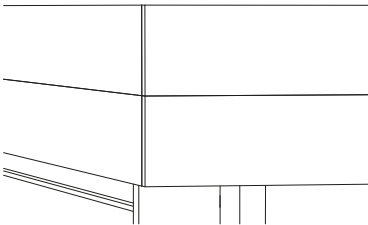

M1 + M2  
Af te korten in lengte !!!!  
À raccourcir en longueur !!!!  
To be shortened in length !!!!

