











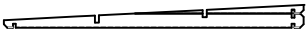
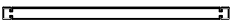
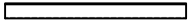

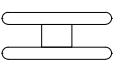

-  **7.53** m²
-  **8.88** m²
-  **14.85** m²

Deuropening / Embrasure de porte / Doorway /
Apertura de puerta / Apertura delle porte / Abertura de portas

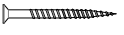
1586
x
1737

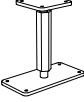
stuklijst / bill of material / liste des pièces

		Ref.			
	A	WW028x149-TPP-2LA-0-	2980	1	
	E	WW028x149-S2IF-000-0-	2180	1	
	G	WW028x149-PRF-000-0-	1800	14	
OR/OF/OU 	J	WW016x095-PLA-000-0-	2950	23	
	J	WW016x120-PLA-000-0-		18	
	K	WW040x120-PT0-1IF-0-	1967	2	
	M1	WW028x040-4FA-000-0-	2100	2	
	H1	WW028x040-4FA-000-0-	2100	1	
	H2	WW016x145-4R8-000-0-	1950	2	
	M1	WW016x145-4R8-000-0-	3010	1	
	T	RW088x088-4R8-IF4-1-	2100	2	
	R1	S617 3.5 x 35 (#30)		1	
	R2	S625 5.0 x 70 (20)		1	
	S	S6747 (46x121)		2	
	R3	S637 2.8 x 50 (#100)		2	
	S1	S5515		2	
	R4	S6810 zeskantenschroef M8x80		8	

PRINCIPE TPP

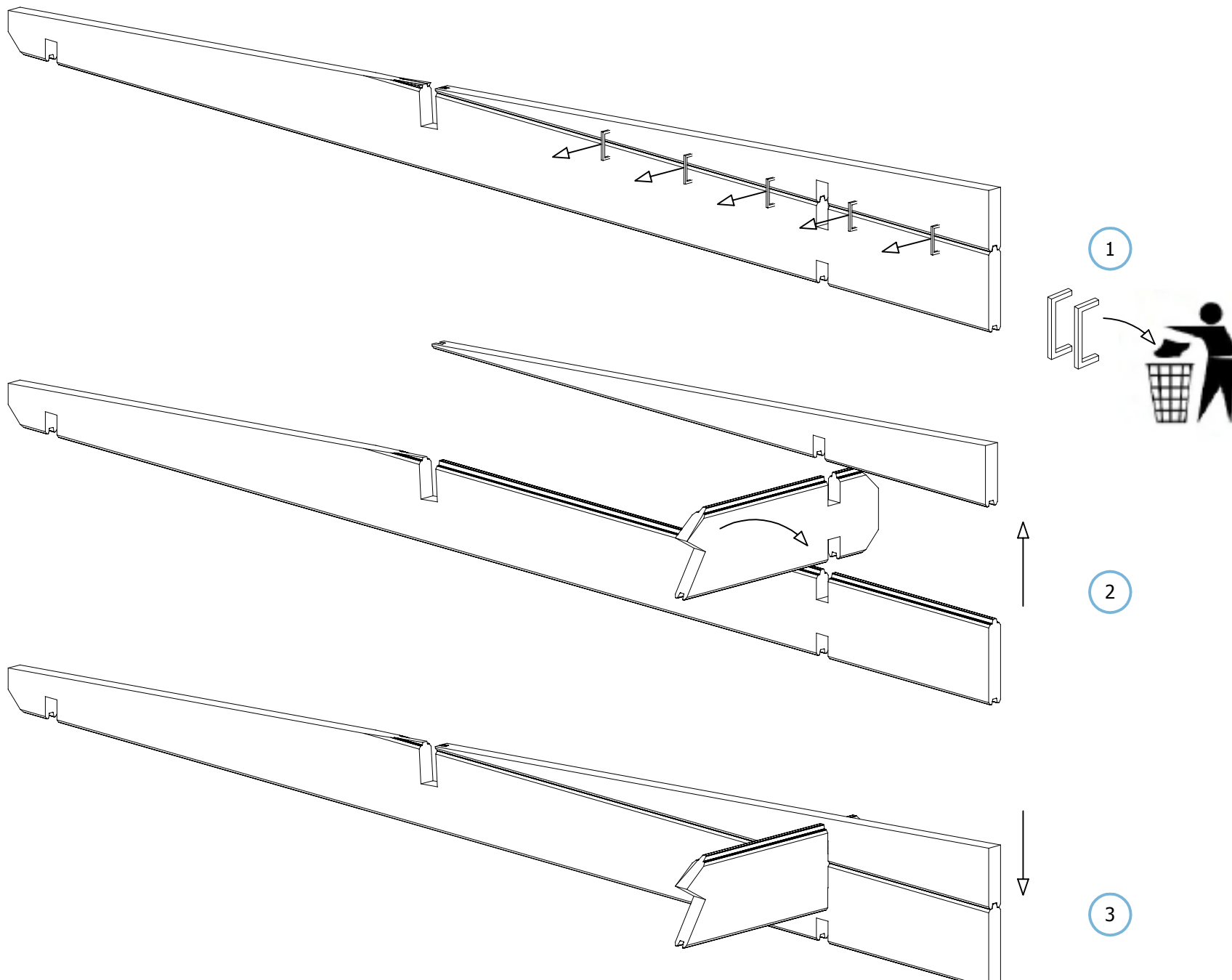

A = 1 S = 2
 E = 1 S1 = 2
 K = 2
 T = 2

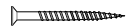

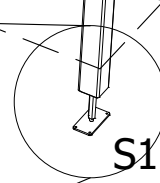
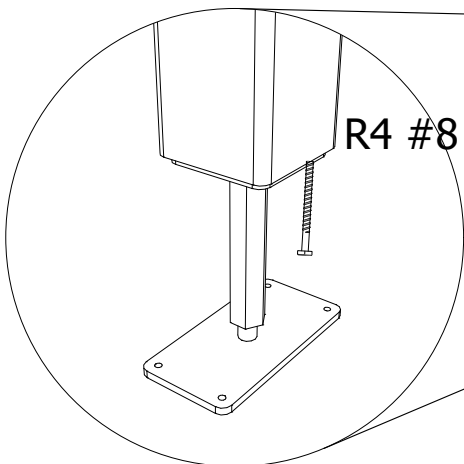
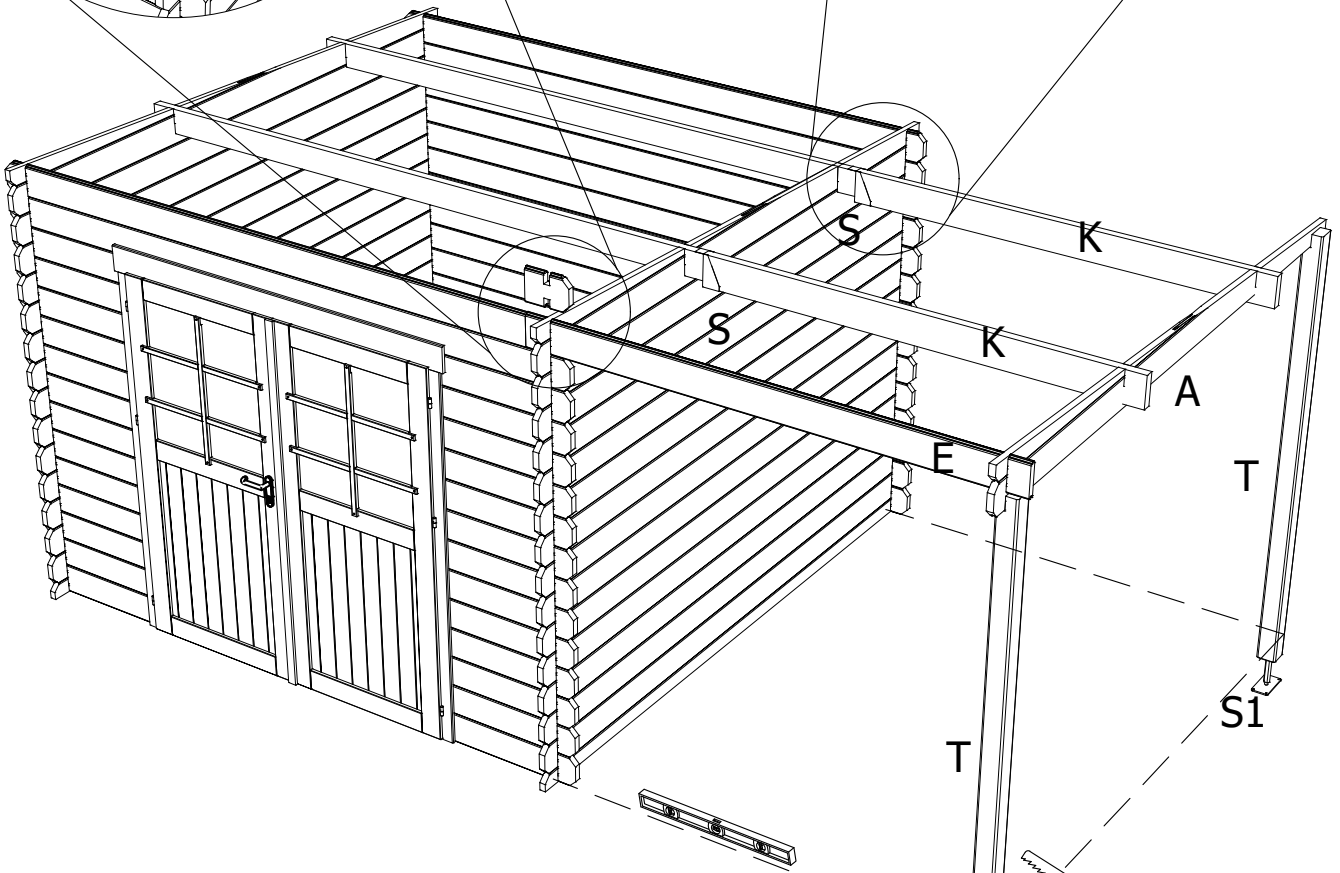
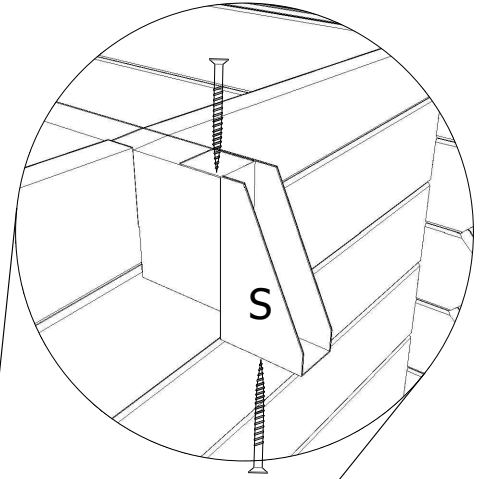
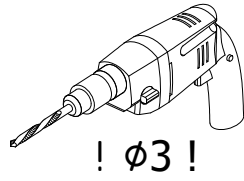
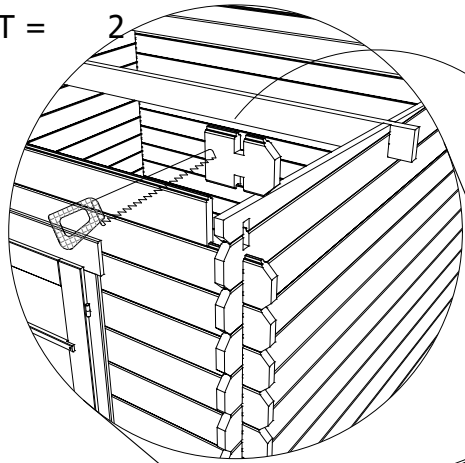
 R1 #8

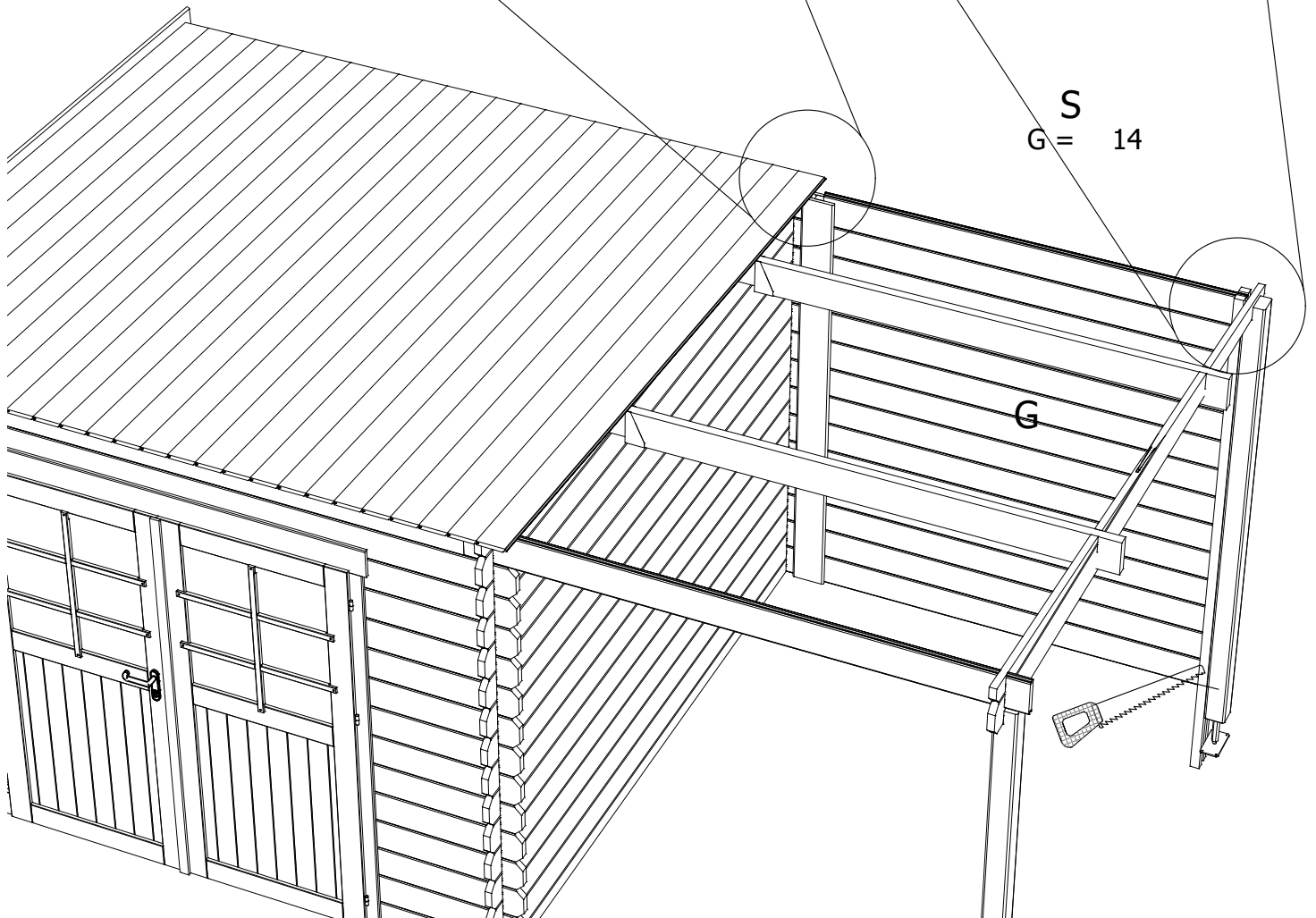
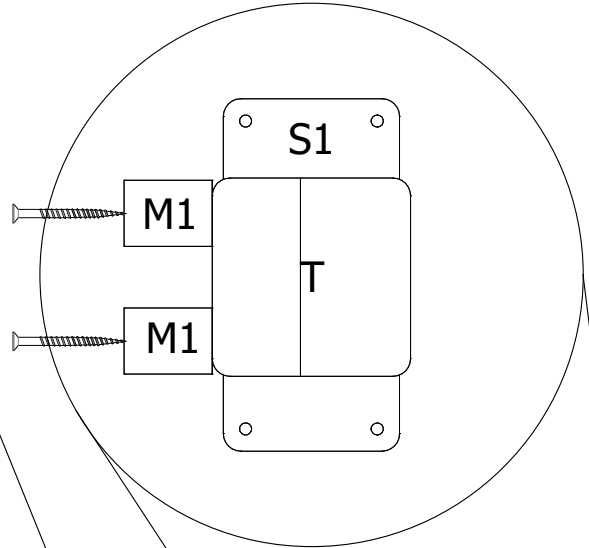
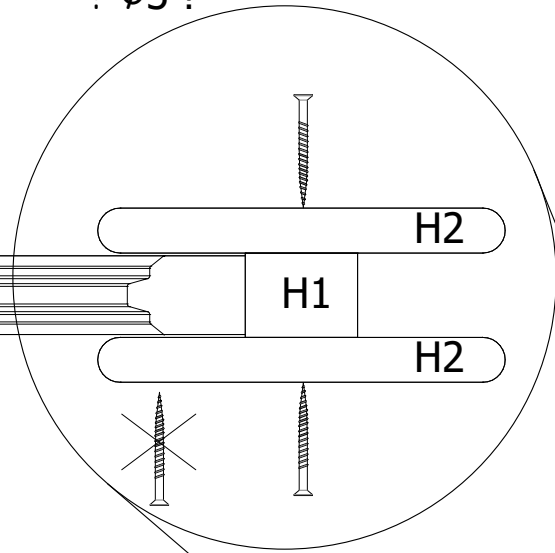
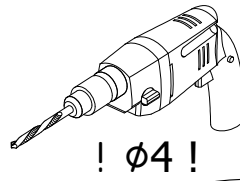
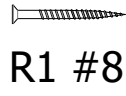
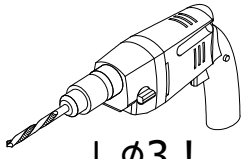

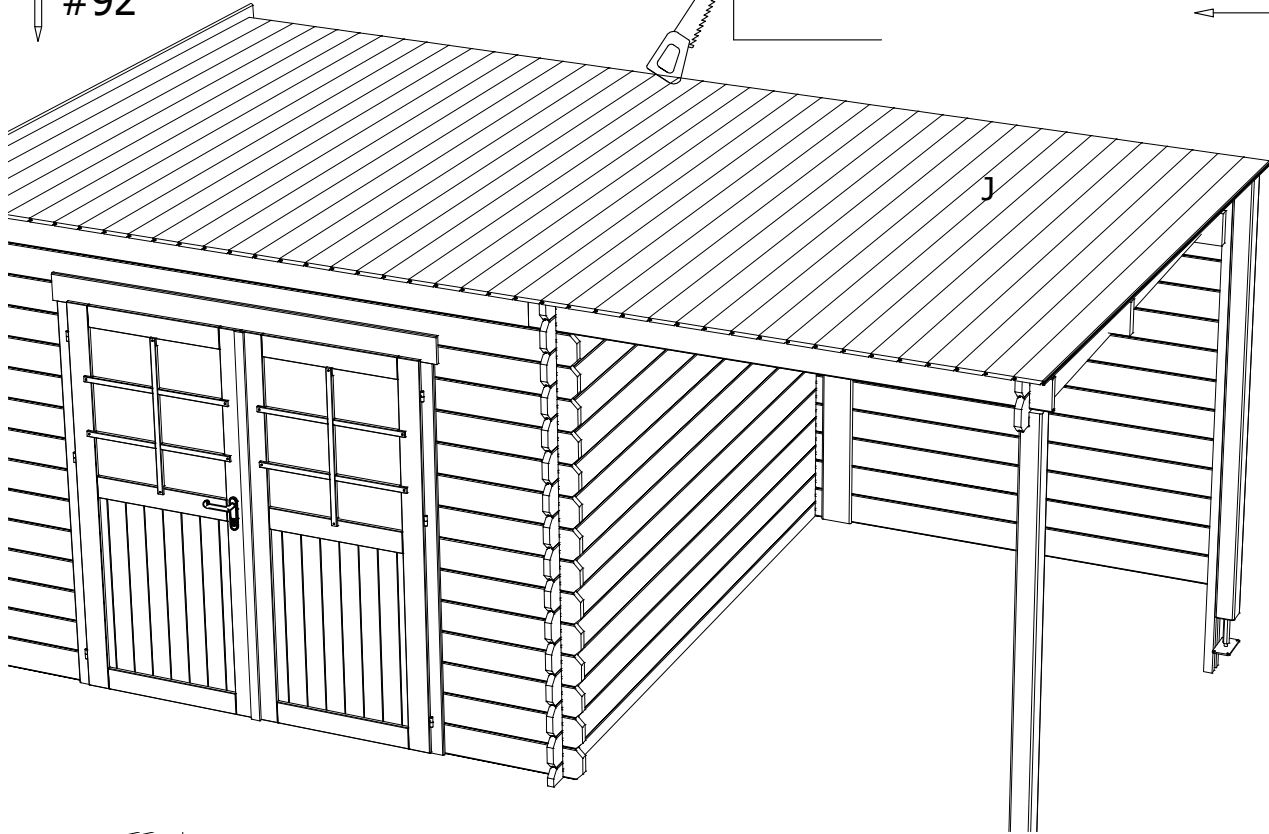
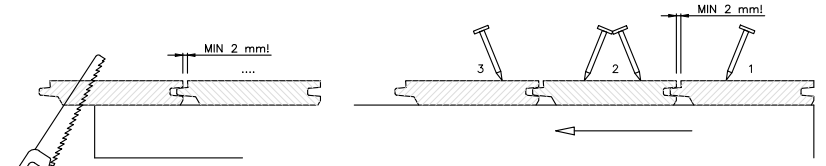

J = 18 OR 23

#92



M = 1
M1 = 1

#20

