

WKS. 1/50

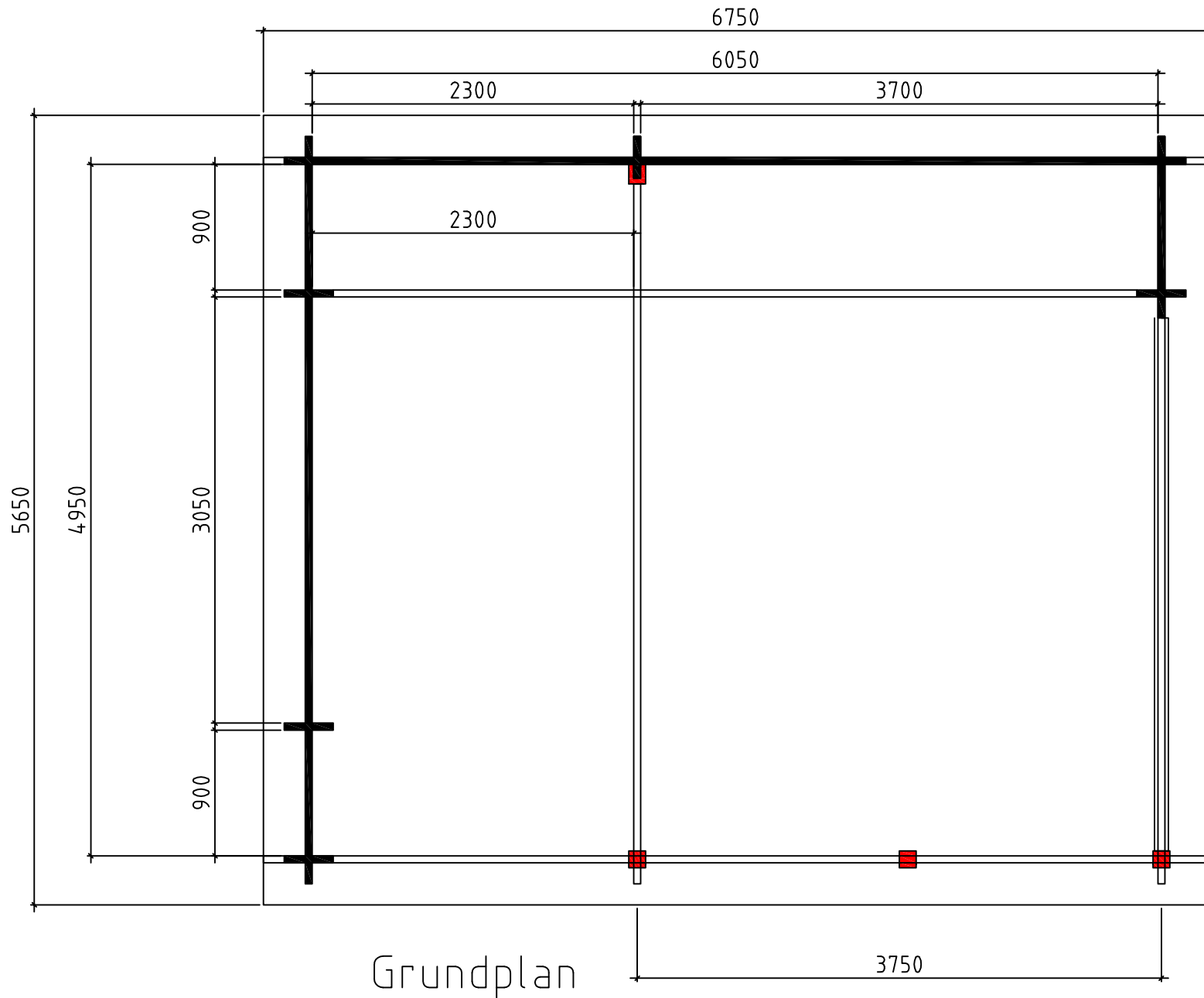

Wks.1/50

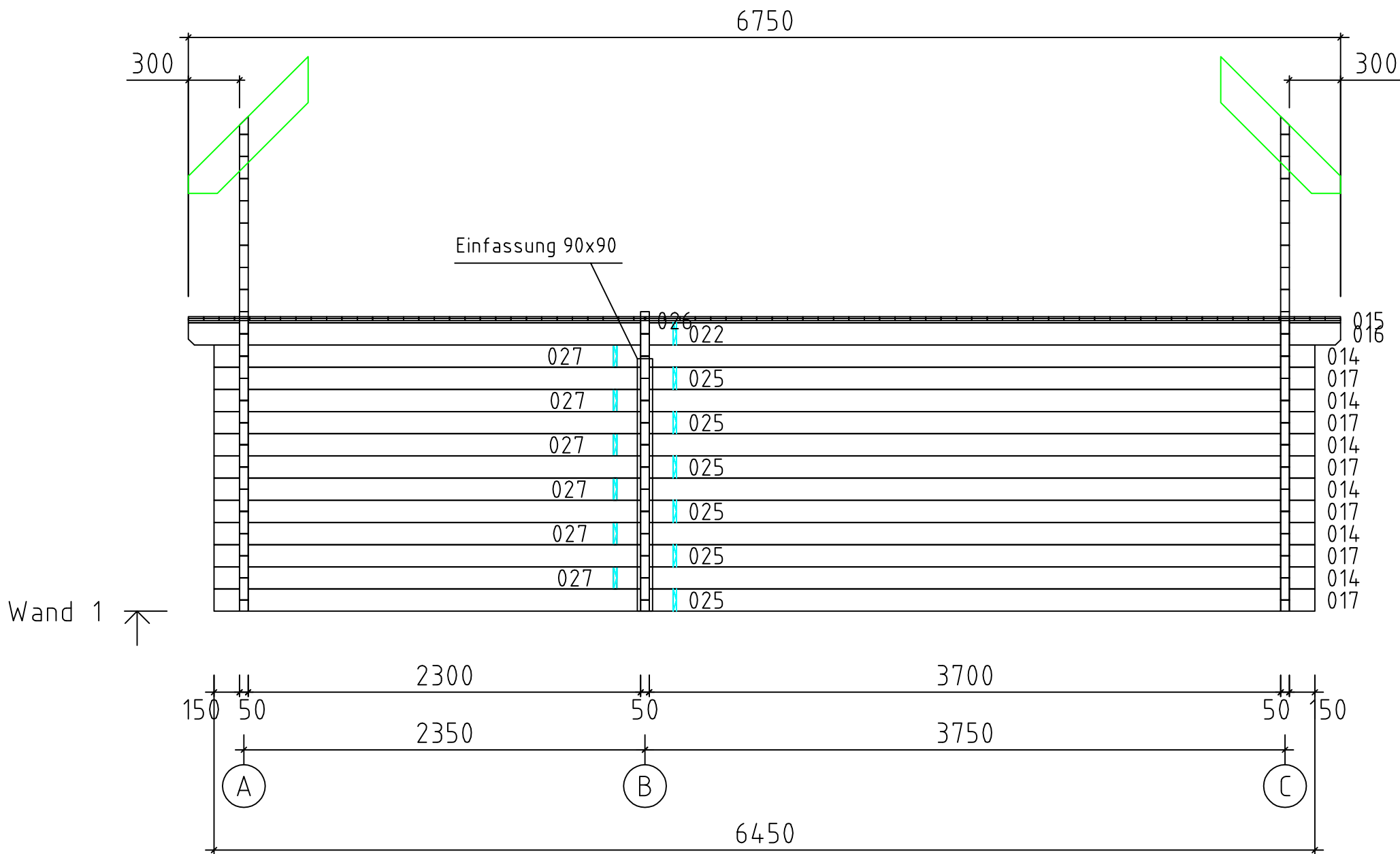



Wks.1/50

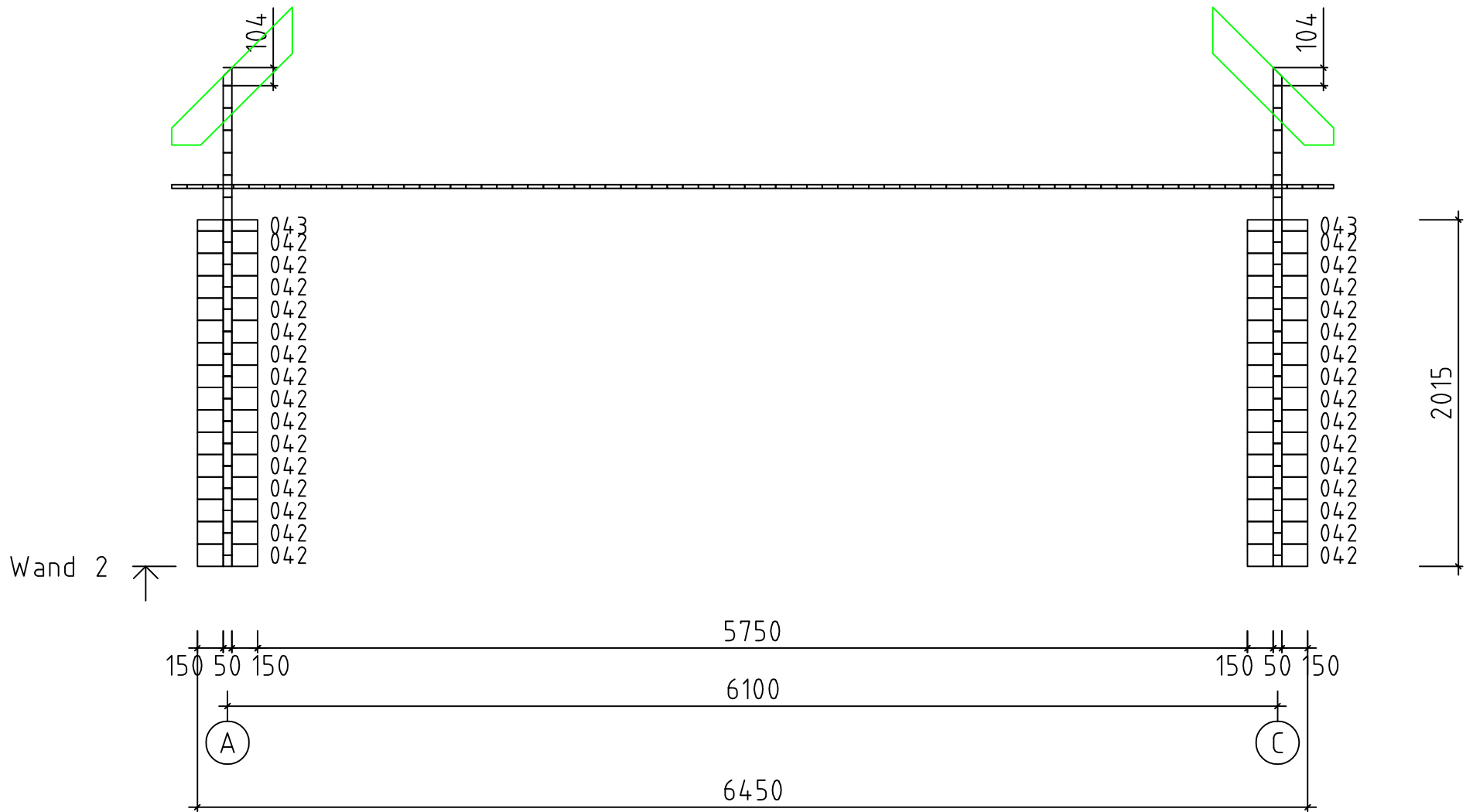

Wks.1/50

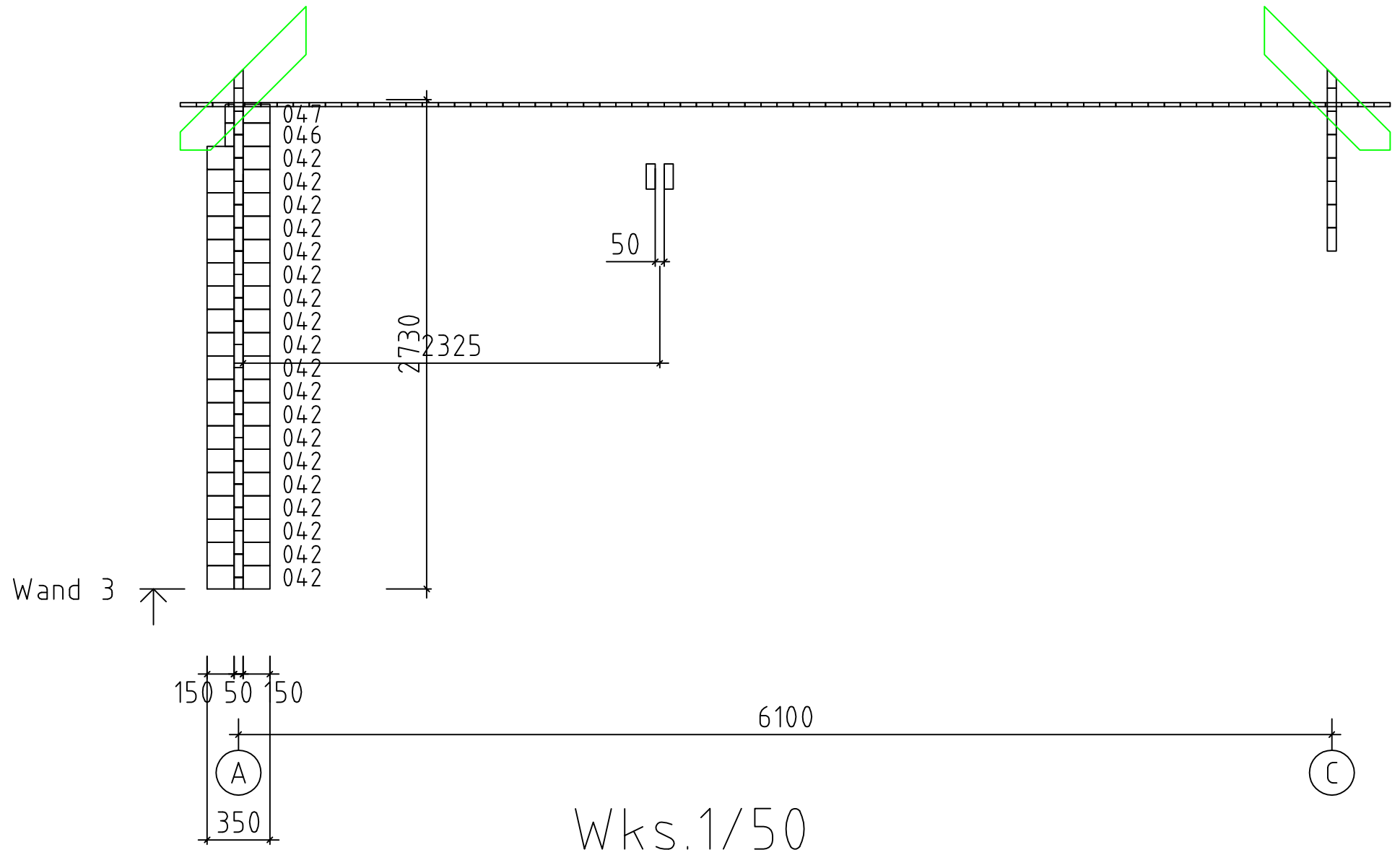

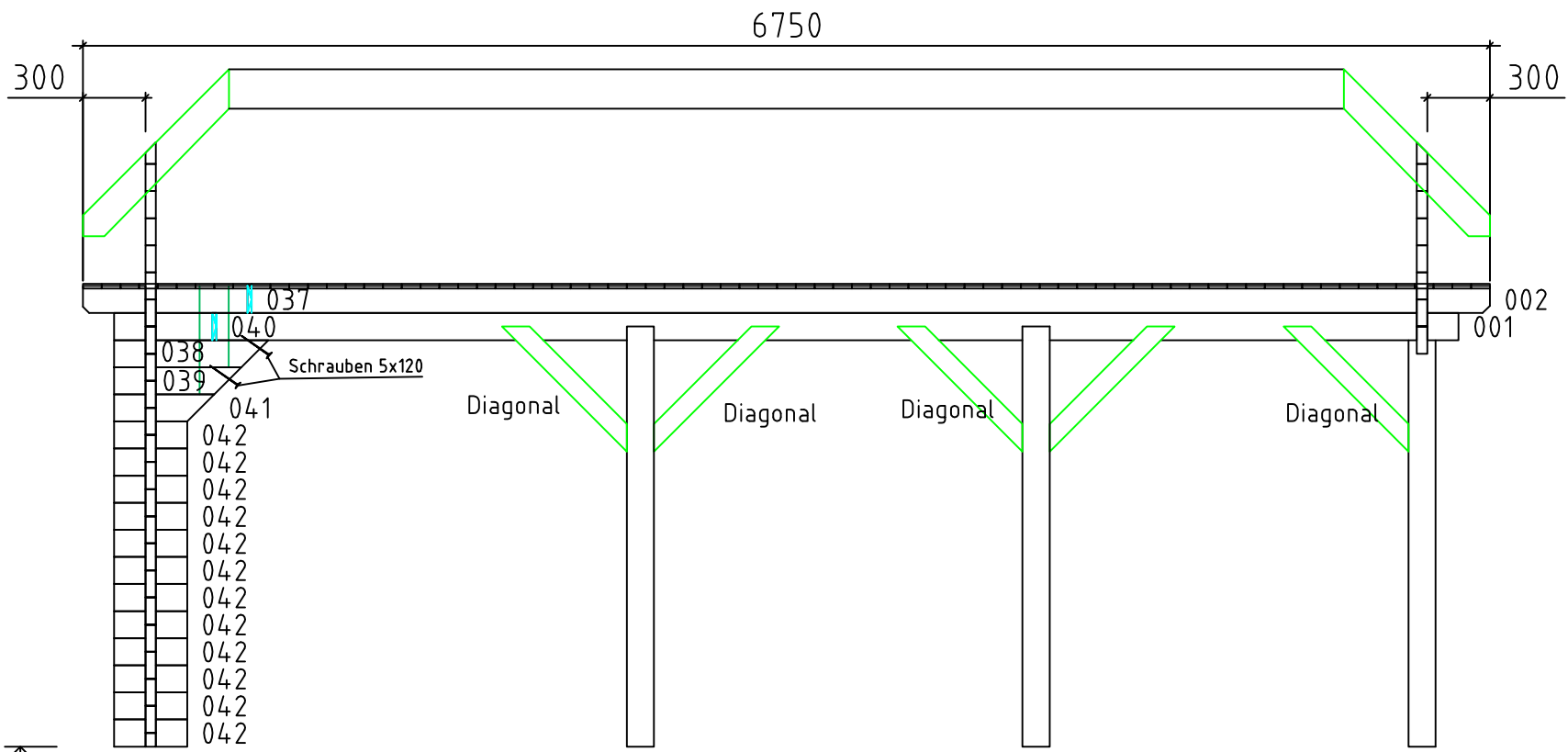

Wand 4 ↑

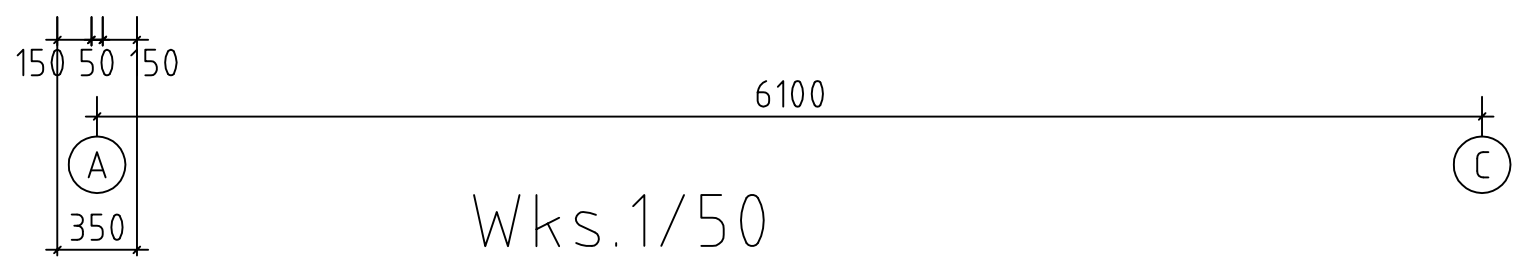

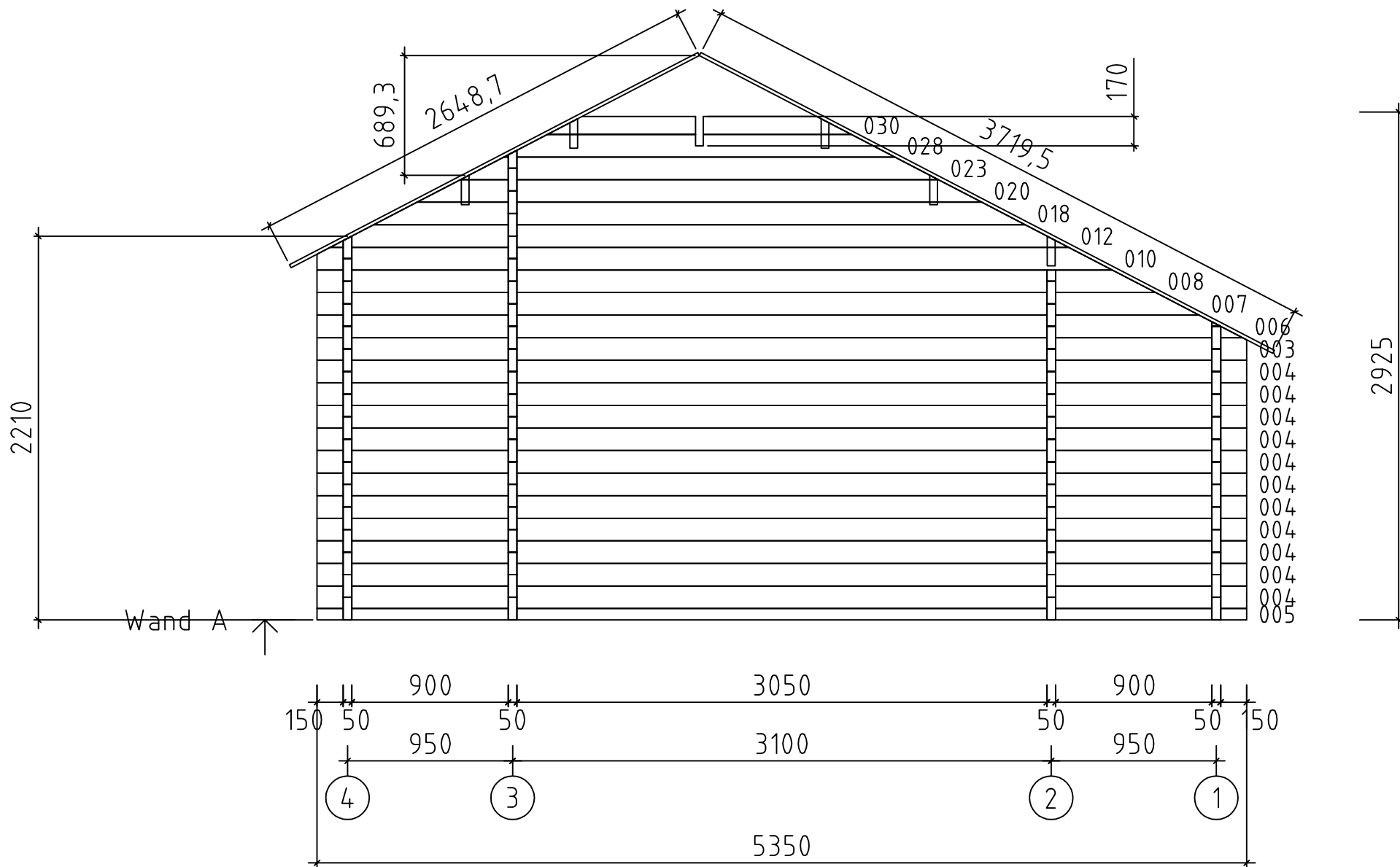

Wks.1/50

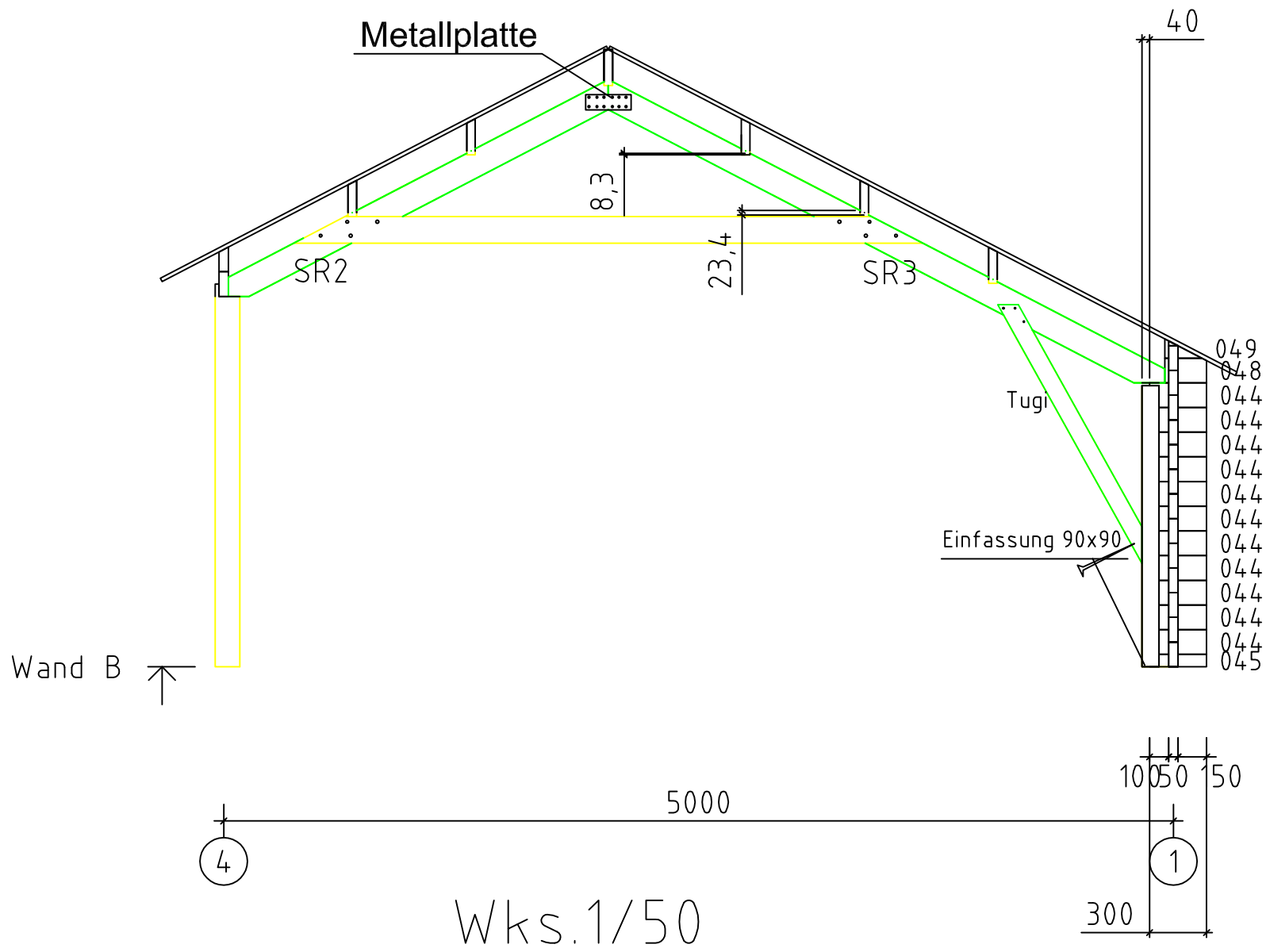

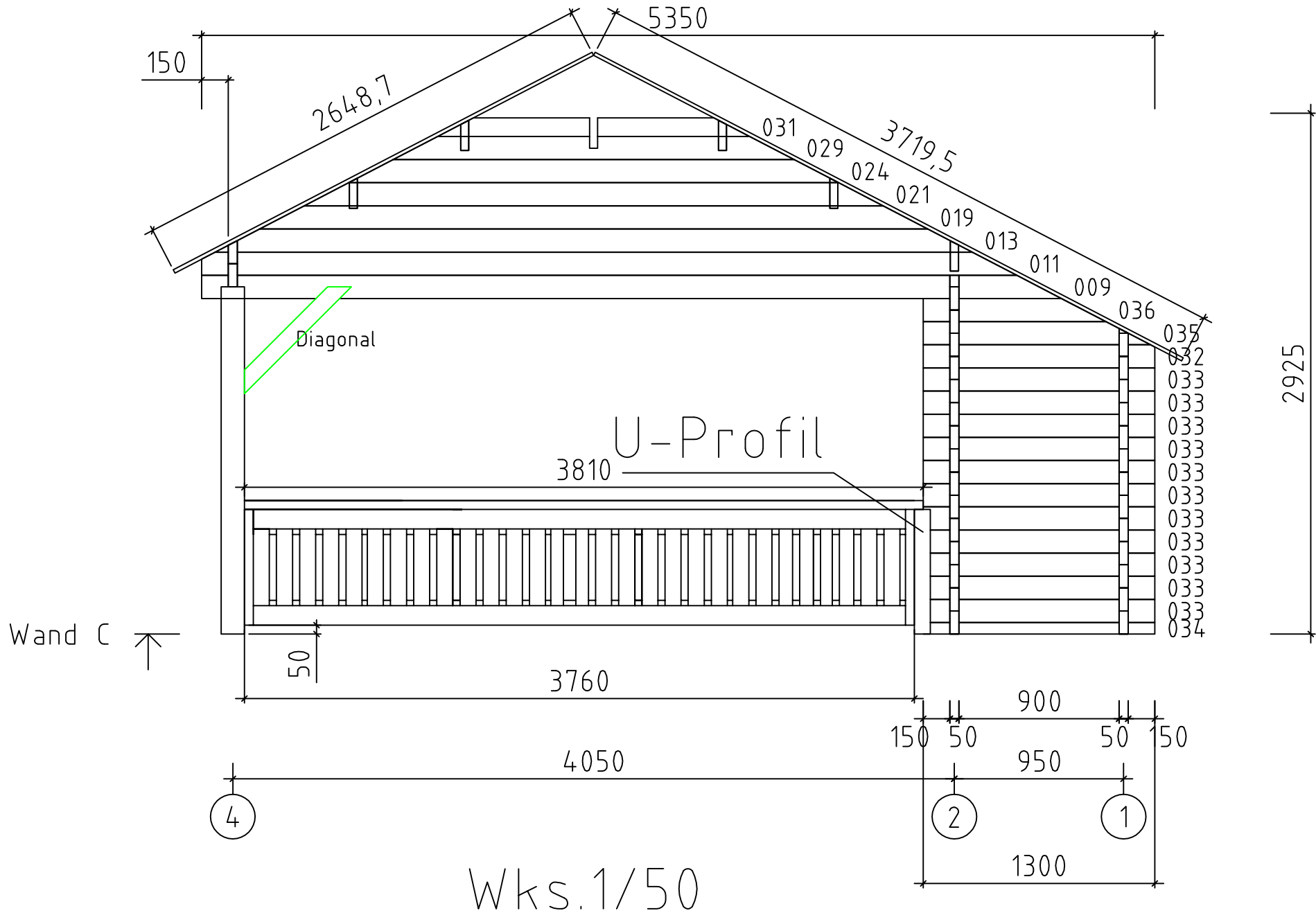

Wks.1/50

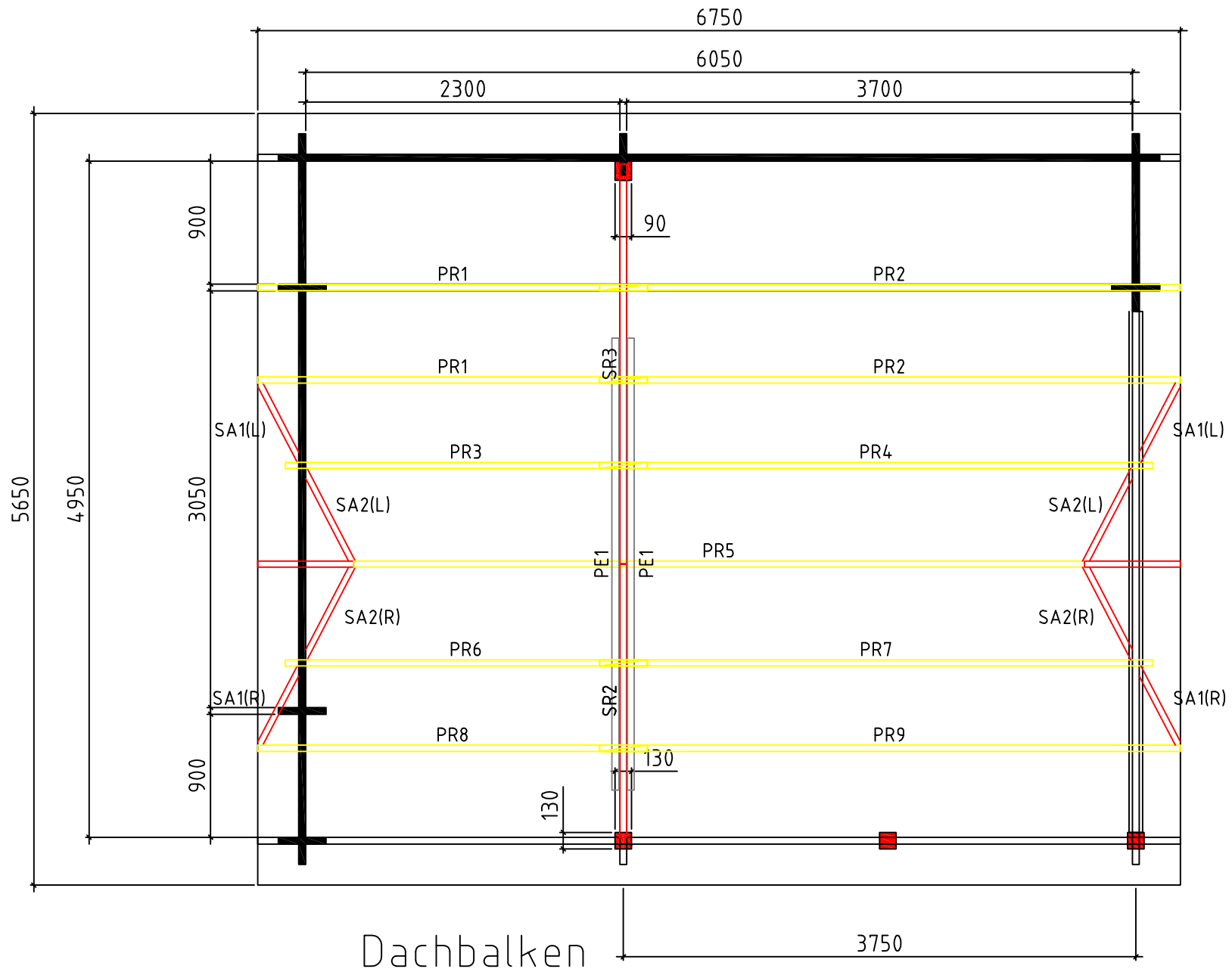

6) Jetzt befestigen Sie mit
spez. Winkeln schrägeren
Pfetten SA1 ja SA2 an First-
und Aussenpfetten mit
Schrauben 3x40

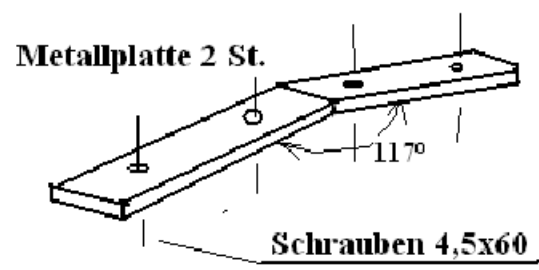
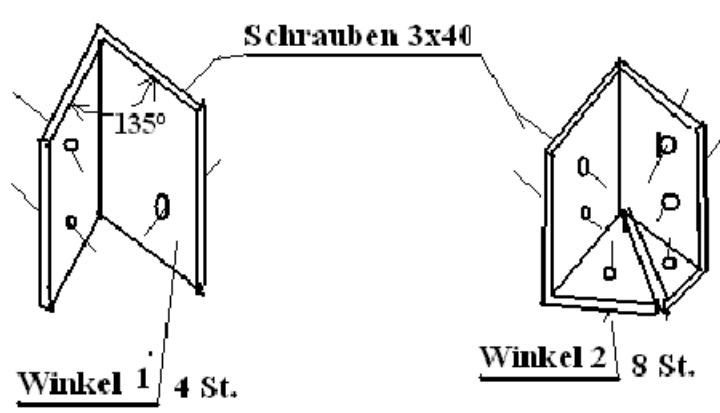
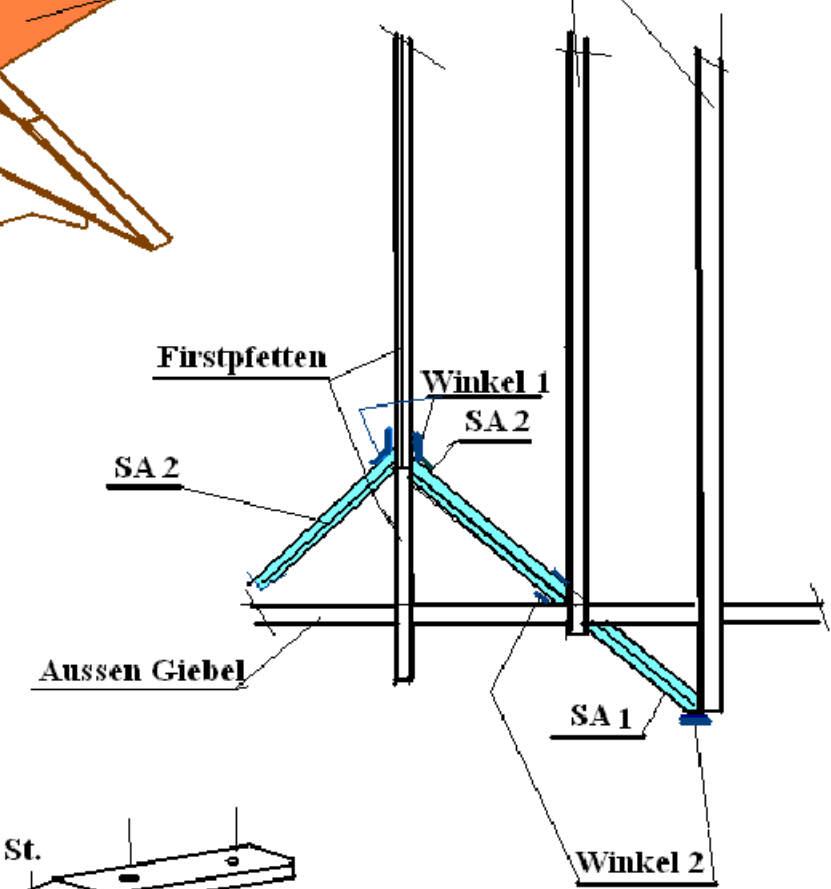
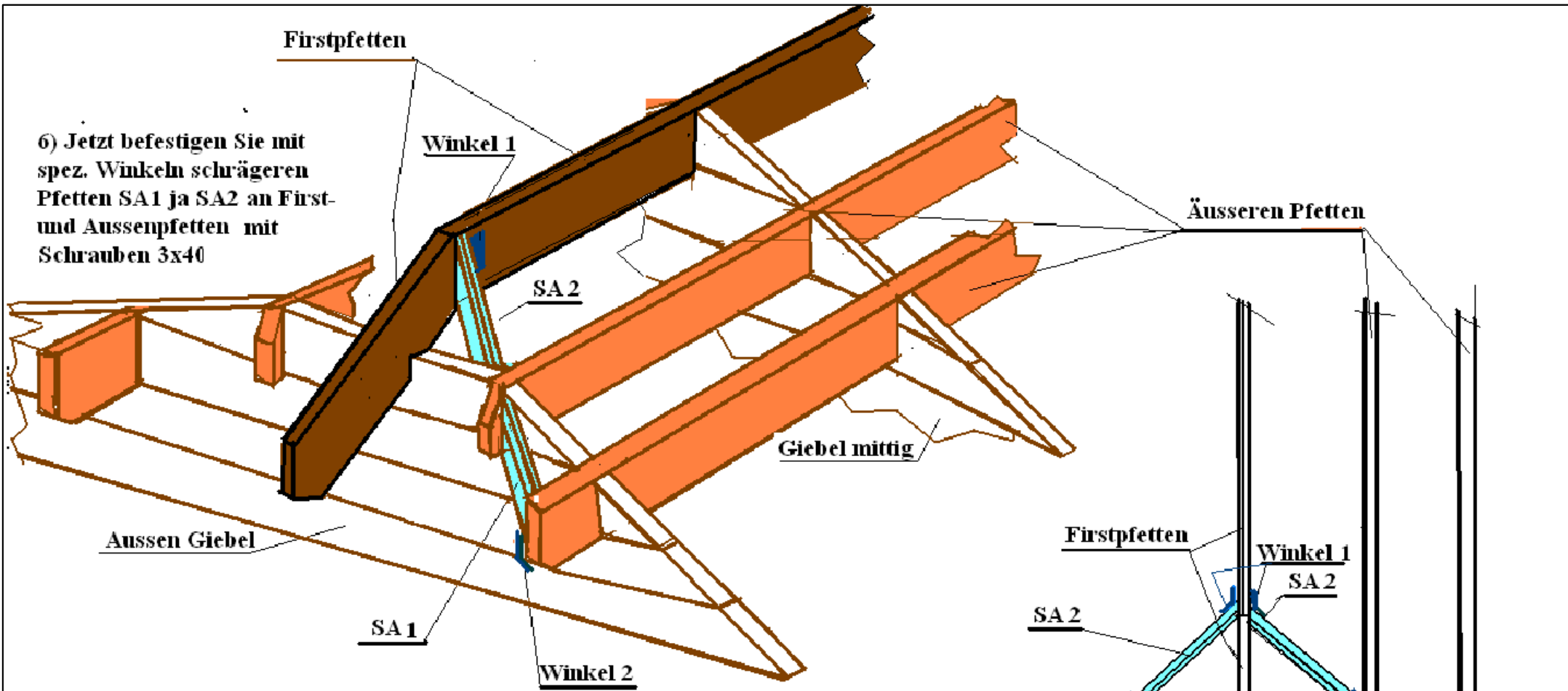

Häusern Serie "W"/50 Die Führung nach der Montage der Pfetten.

- 1) Stellen Sie auf die feste Gründung die erste Reihe Wandbohlen fest
- 2) Weiter die Wände nach der Zeichnung bis zum Giebeln aufzustellen. Die Giebeln gehören auch in die Wände.
- 3) Danach müssen Sie die Pfetten aufbauen. Zuerst montieren Sie

Firstpfetten zusammen so, wie auf Zeichnung sehen:

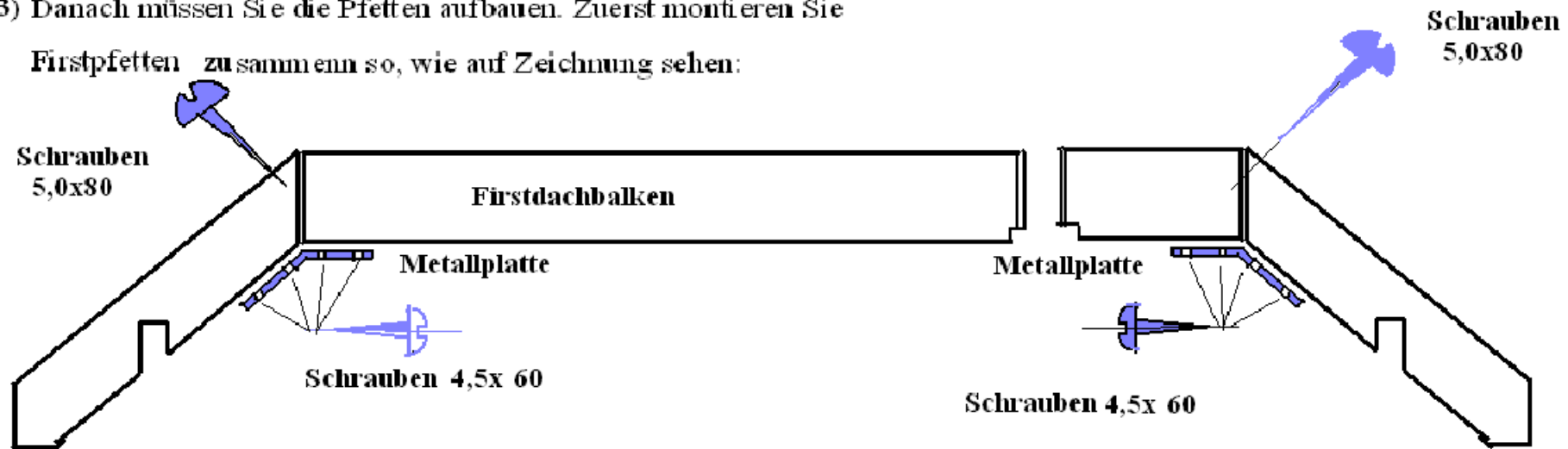



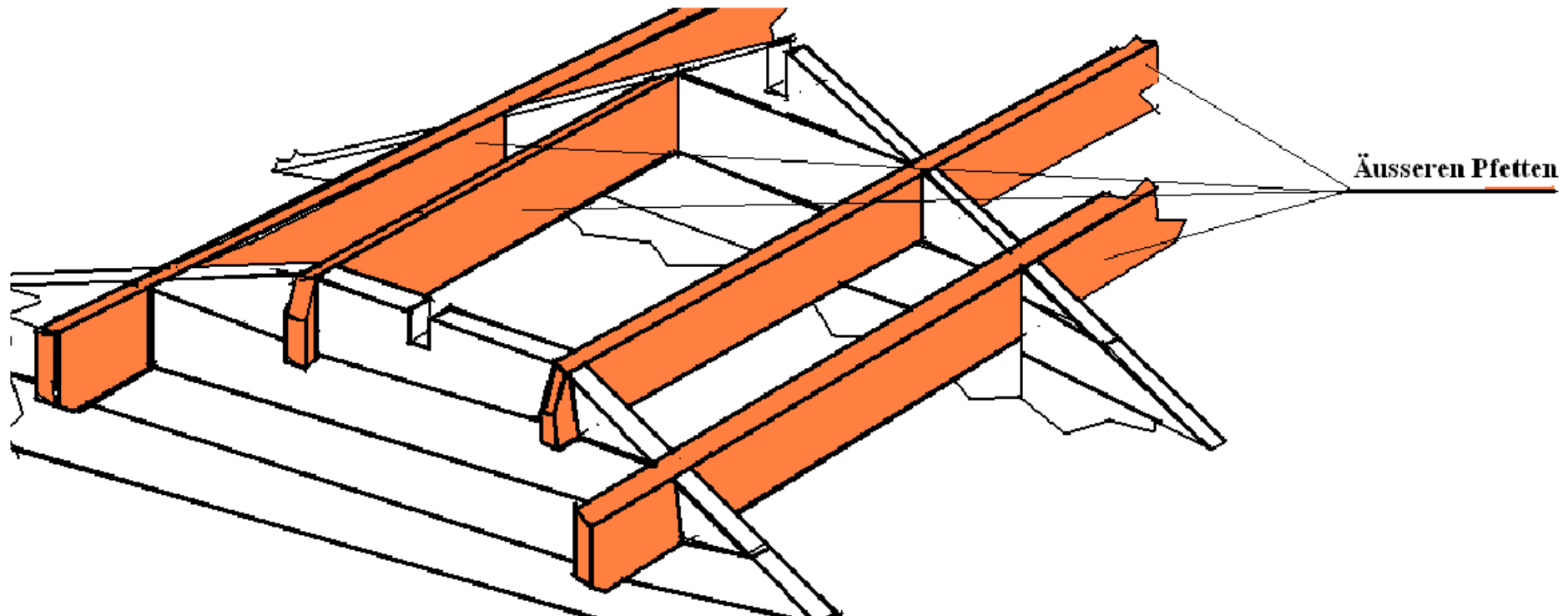



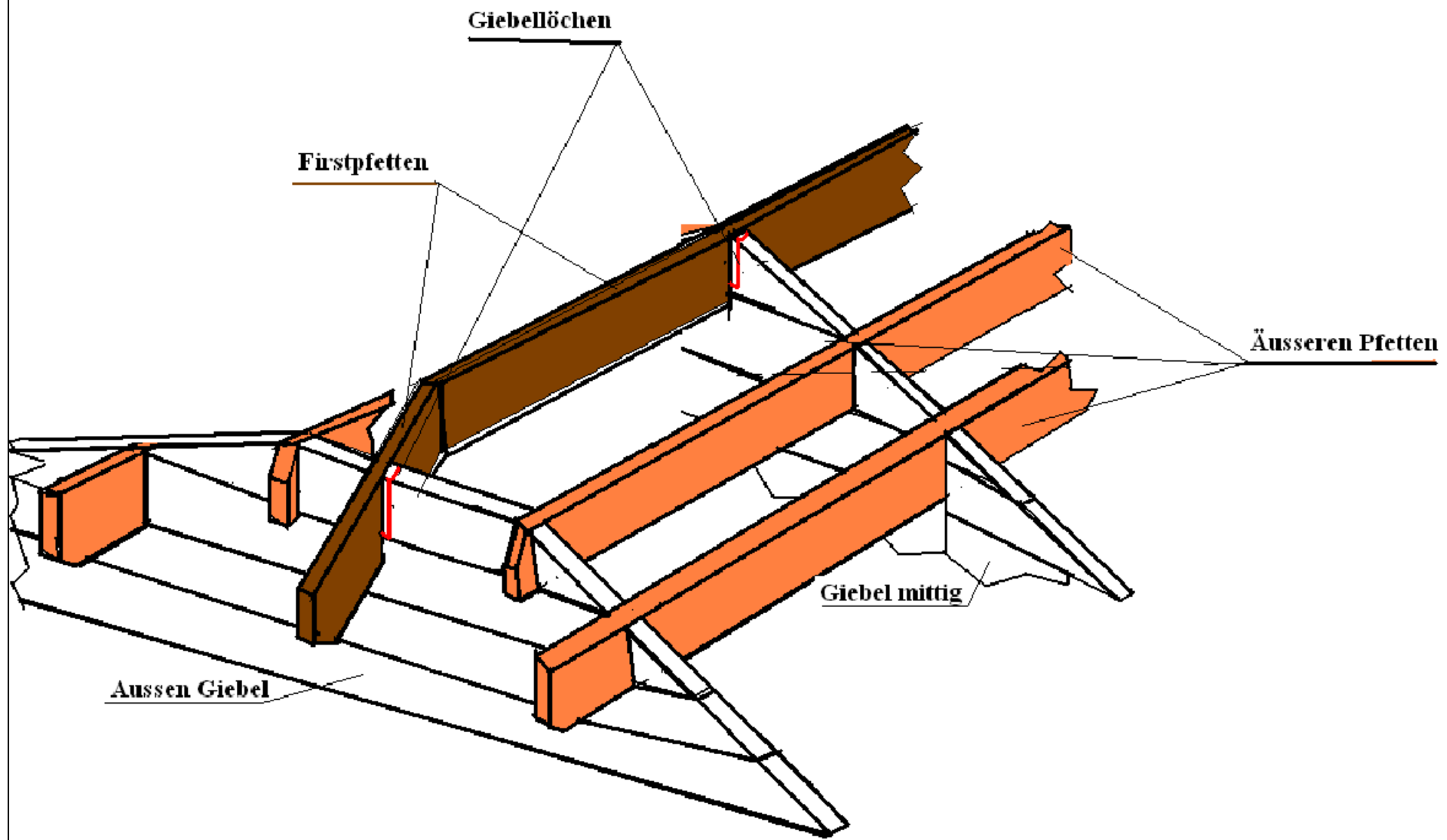

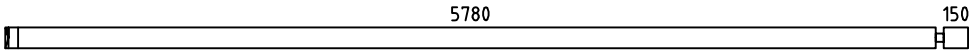
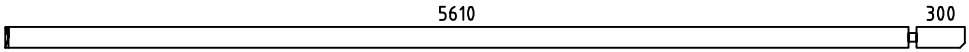
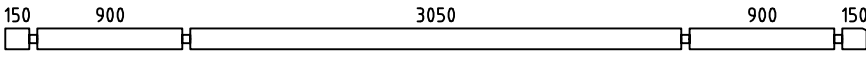
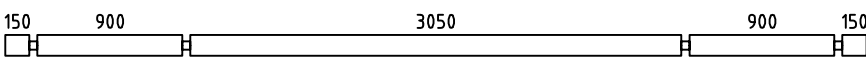
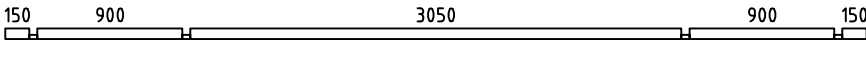
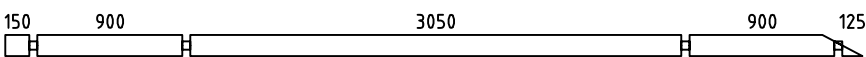
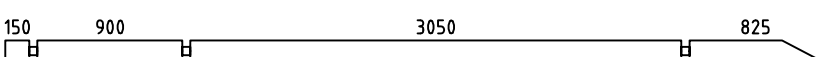
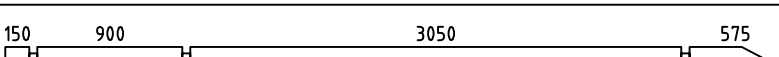
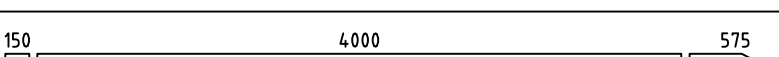
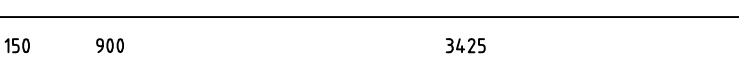
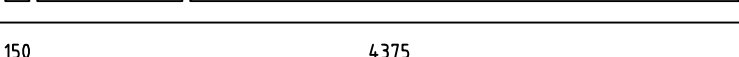
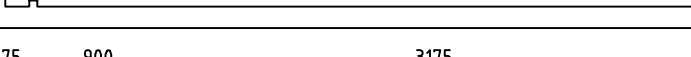
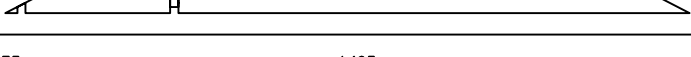
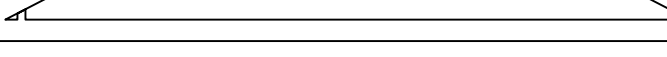
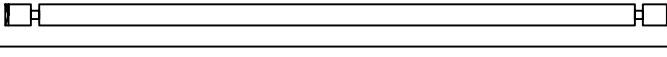
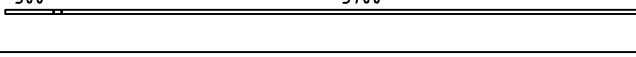
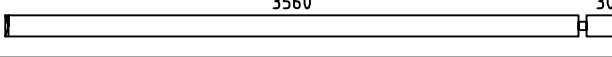
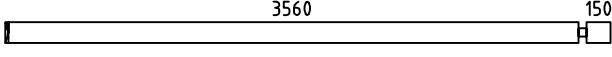
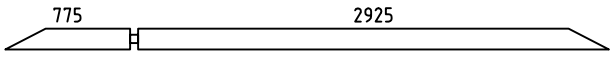
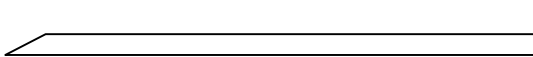
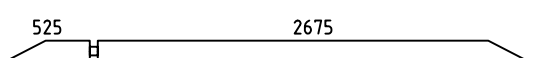
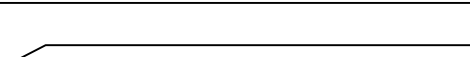
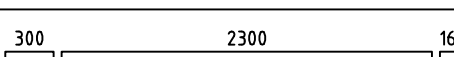
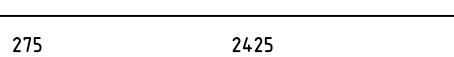
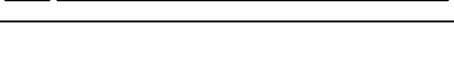

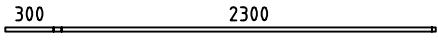
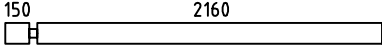
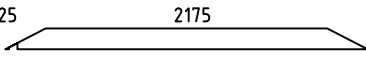
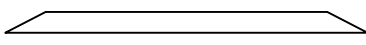
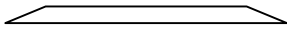
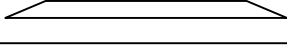
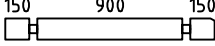
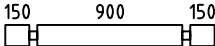
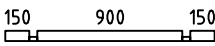
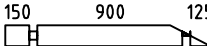
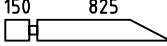
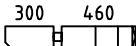
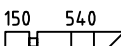
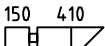
- 4) Versetzen Sie die äusseren Dachpfetten in Giebellöcher. Zwei Stk. links ja Zwei Stk. rechts









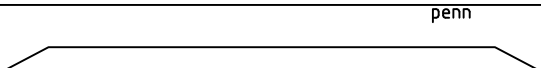



5) Jetzt müssen Sie **zusammenbefestigen Firstpfetten in die Giebellöcher aufgehoben,**

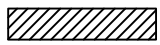

Pos	Wks.1/50	ST	F (mm)	L (mm)
001		1	50x130	5980
002		1	50x130	5960
003		1	50x130	5350
004		11	50x130	5350
005		1	50x65	5350
006		1	50x130	5325
007		1	50x130	5075
008		1	50x130	4825
009		1	50x130	4825
010		1	50x130	4575
011		1	50x130	4575
012		1	50x130	4250
013		1	50x130	4250
014		6	50x130	4110
015		1	50x26	4075
016		1	50x130	3910
017		6	50x130	3760
018		1	50x130	3750
019		1	50x130	3750
020		1	50x130	3250
021		1	50x130	3250
022		1	50x130	2860
023		1	50x130	2750
024		1	50x130	2750
025		6	50x130	2710

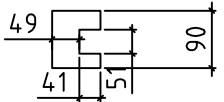
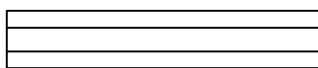
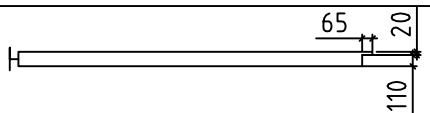
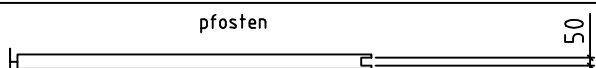
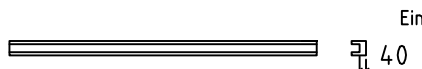
Pos	Wks.12/50	ST	F (mm)	L (mm)
026		1	50x26	2675
027		6	50x130	2360
028		1	50x130	2250
029		1	50x130	2250
030		1	50x104	1750
031		1	50x104	1750
032		1	50x130	1300
033		11	50x130	1300
034		1	50x65	1300
035		1	50x130	1275
036		1	50x130	1025
037		1	50x130	810
038		1	50x130	740
039		1	50x130	610
040		1	50x130	490
041		1	50x130	480
042		61	50x130	350
043		2	50x65	350
044		11	50x130	300
045		1	50x65	300
046		1	50x130	250
047		1	50x104	250
048		1	50x130	220
049		1	50x101	195
PE1		2	50x140	3311

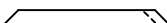
Pos	Wks.1/50	ST	F (mm)	L (mm)
	 Metallplatte	2	80x240	
	Metallplatte 	2		
	Winkel 1 	4		
	Winkel 2 	8		
	Schrauben 4,5x60=18st. 3,0x40=64 st. 5x80=8st. 5x120=12st.		kmpl.	
	Abdeckleiste 		20x40	50m
	Dachpappenleiste 	20	20x40	1600
	Giebelbretter 	4	20x120	2750
	Giebelbretter 	2	20x120	3820
	Giebeldeckbretter 	4	20x70	2750
	Giebeldeckbretter 	2	20x70	3820
	Barieren	1	700x3820	
	U-Profil  	1	90x90	700
	 pfoften	2	130x130	1950
	 pfoften	1	130x130	1885
	 Einfassung	1	90X90	1480
SR1	 Tugi	1	90X90	1560
SR4	Diagonal 	7	90X90	800
	Dübel	3	11,5x11,5	390