

# Schnitt

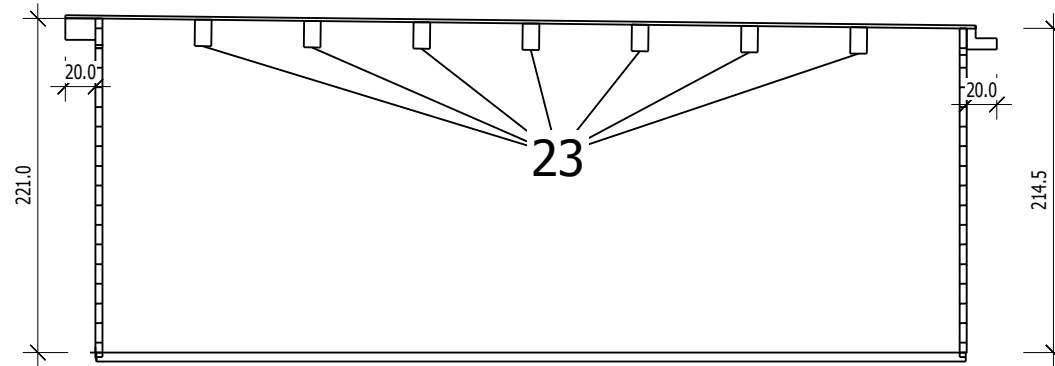

# Grundrahmenplan

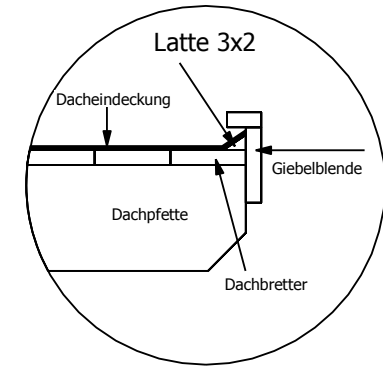
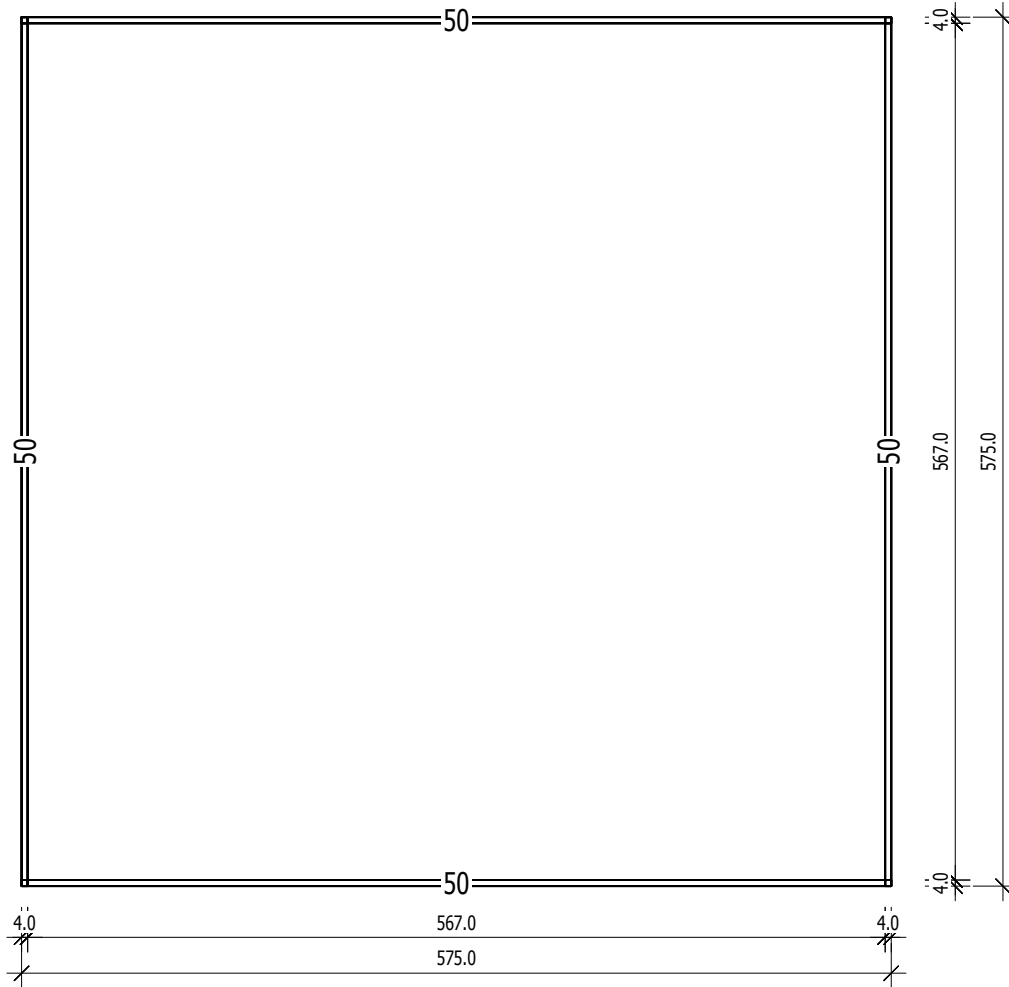

# Grundrahmenplan

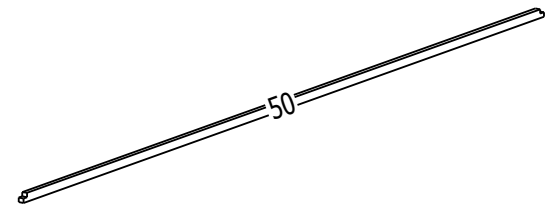
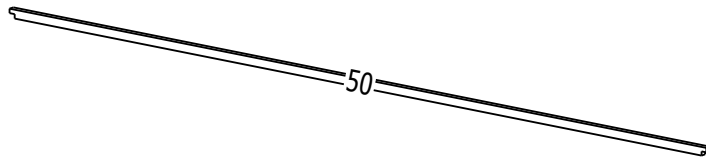
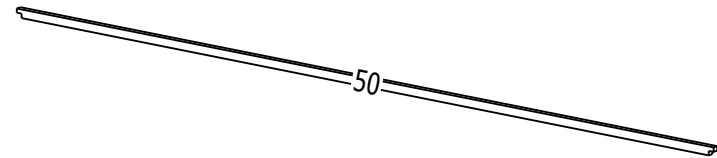
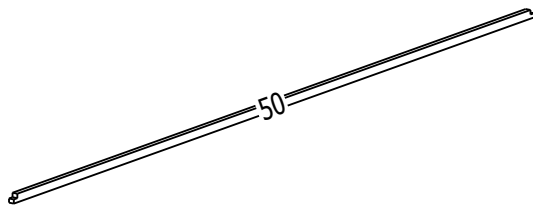

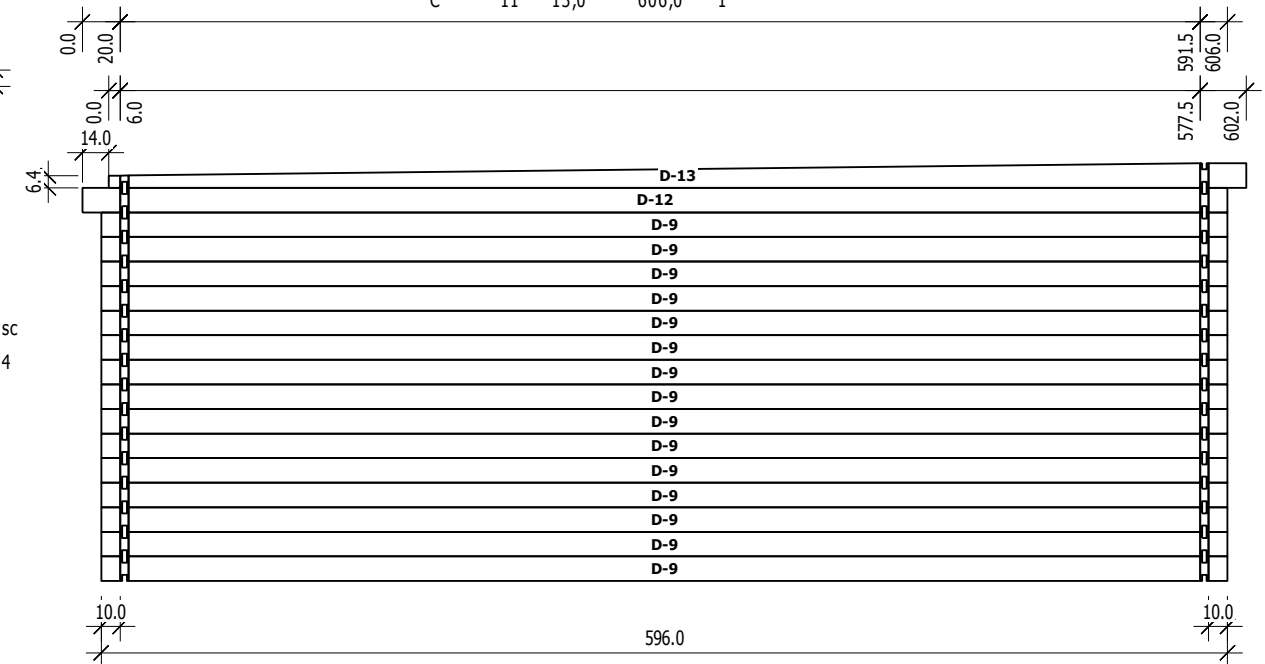
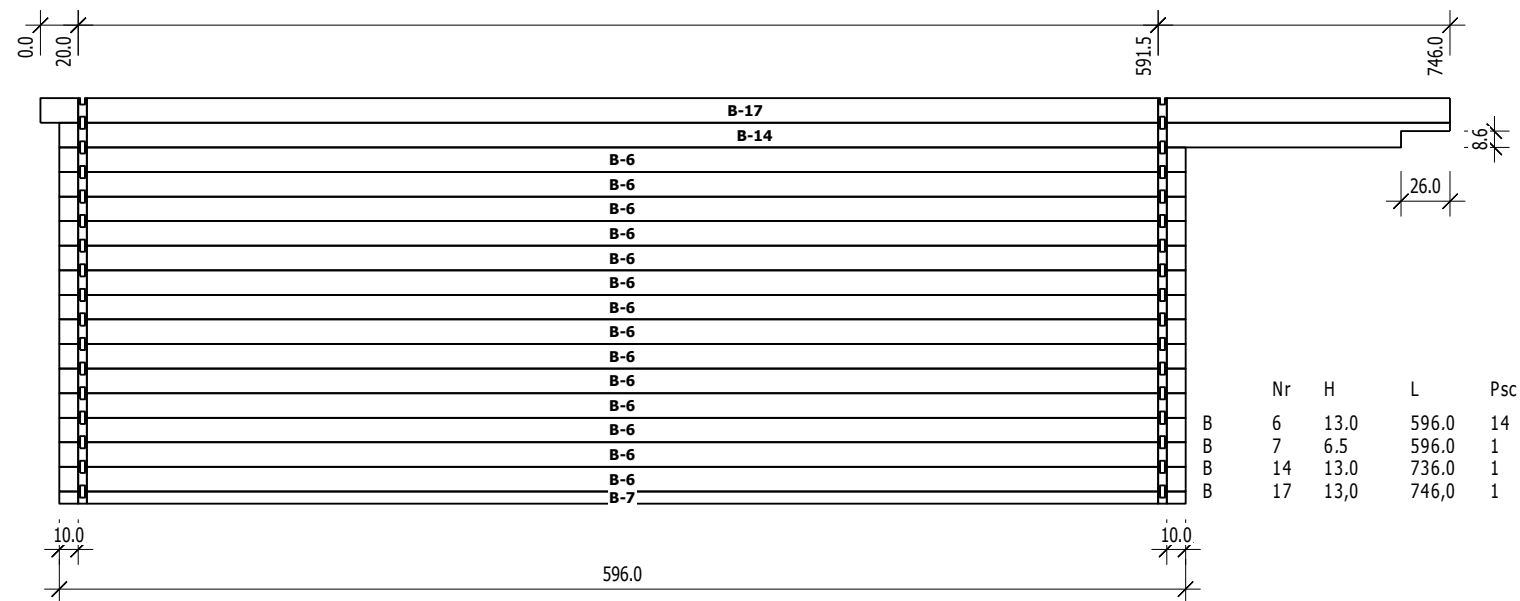
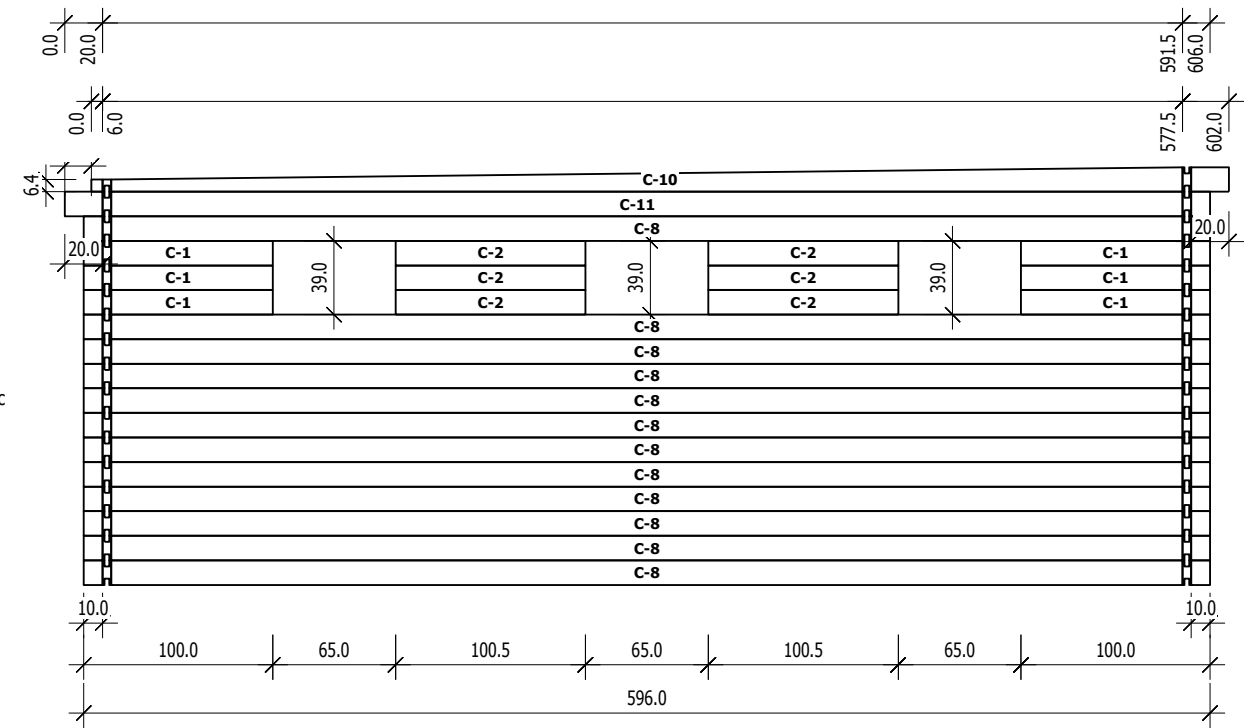
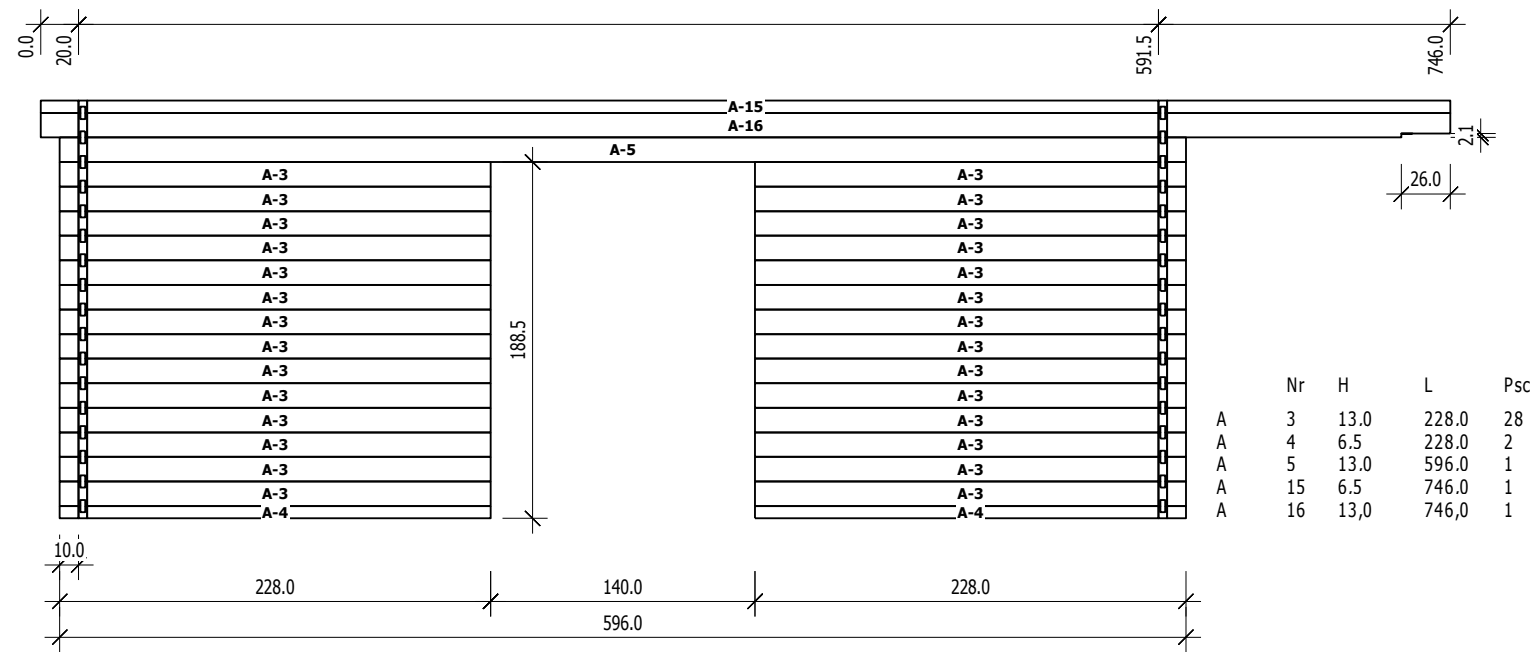

	Nr	H	L	Psc
D	9	13.0	596.0	15
D	13	13.0	602.0	1
D	12	13.0	606.0	1