

Bemerkung: die Ansicht von Turen, Fenster und anderen Teilen kann abweichen von diesem Bild

Grundriss

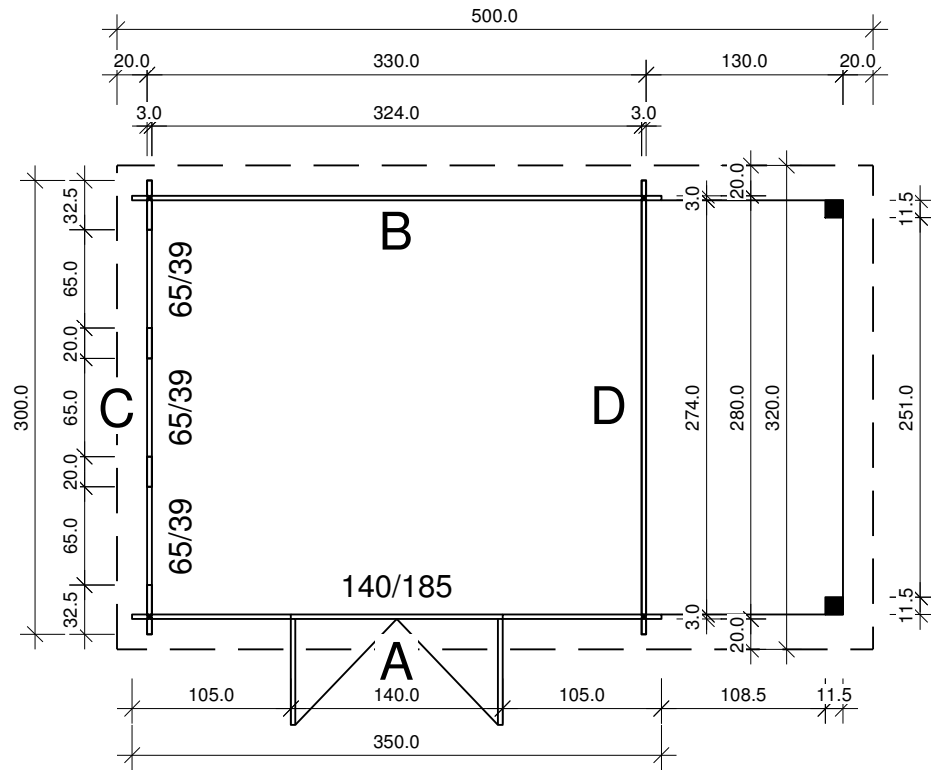

Schnitt

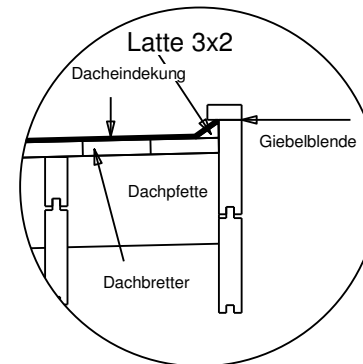
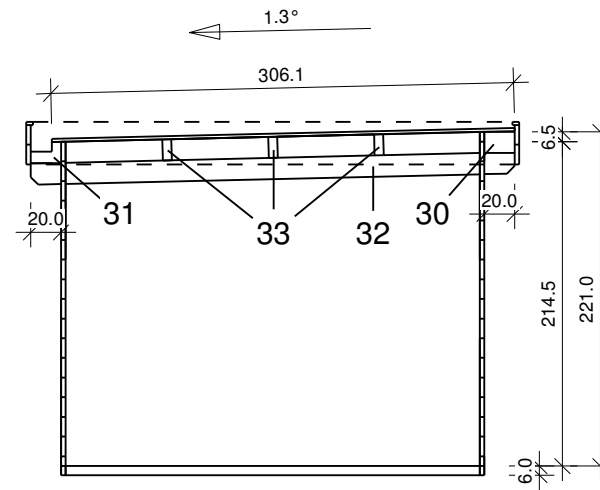

Grundrahmenplan

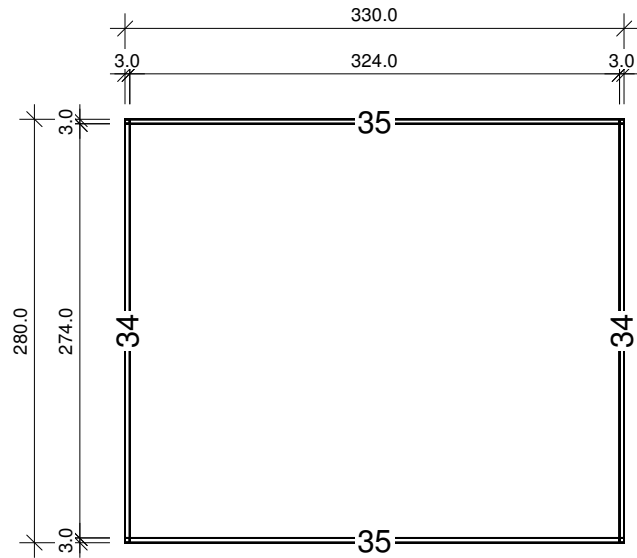

| Nr. | B [cm] | H [cm] | L [cm] | Psc |
|-----|-----------|-----------|-----------|-----|
| 34 | 3,0 | 6,0 | 280,0 | 2 |
| 35 | 3,0 | 6,0 | 330,0 | 2 |

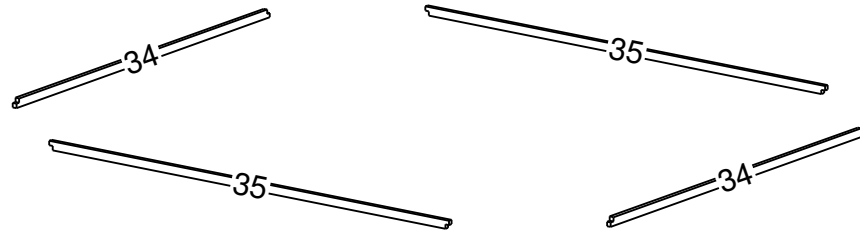

A

M 1:40

Ansicht von Aussen

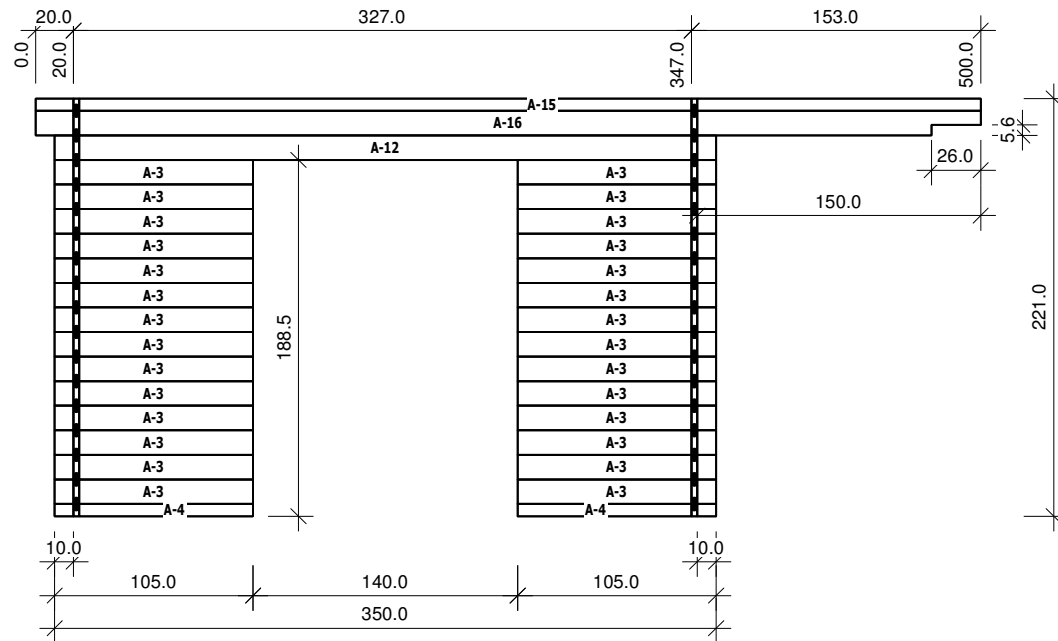

| Nr | H | L | Psc |
|----|----|------|----------|
| A | 3 | 13.0 | 105.0 28 |
| A | 4 | 6.5 | 105.0 2 |
| A | 12 | 13.0 | 350.0 1 |
| A | 15 | 6.5 | 500.0 1 |
| A | 16 | 13.0 | 500.0 1 |
| | | | 33 |

B

M 1:40

Ansicht von Innen

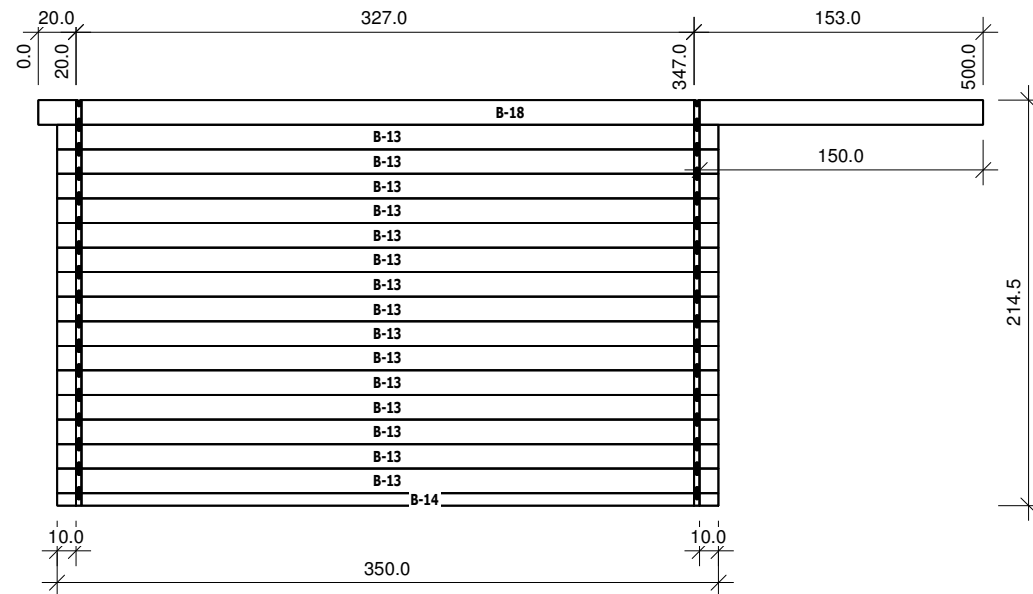

| Nr | H | L | Psc |
|----|----|------|----------|
| B | 13 | 13.0 | 350.0 15 |
| B | 14 | 6.5 | 350.0 1 |
| B | 18 | 13.0 | 500.0 1 |
| | | | 17 |

C

M 1:40

Ansicht von Aussen

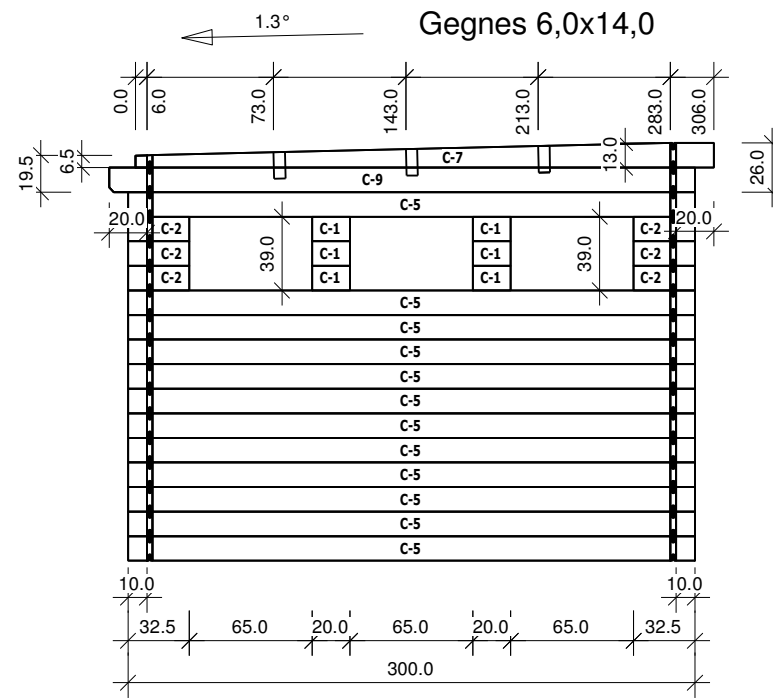

| Nr | H | L | Psc |
|----|---|------|----------|
| C | 1 | 13.0 | 20.0 6 |
| C | 2 | 13.0 | 32.5 6 |
| C | 5 | 13.0 | 300.0 12 |
| C | 7 | 13.0 | 306.0 1 |
| C | 9 | 13.0 | 310.0 1 |
| | | | 26 |

D

M 1:40

Ansicht von Innen

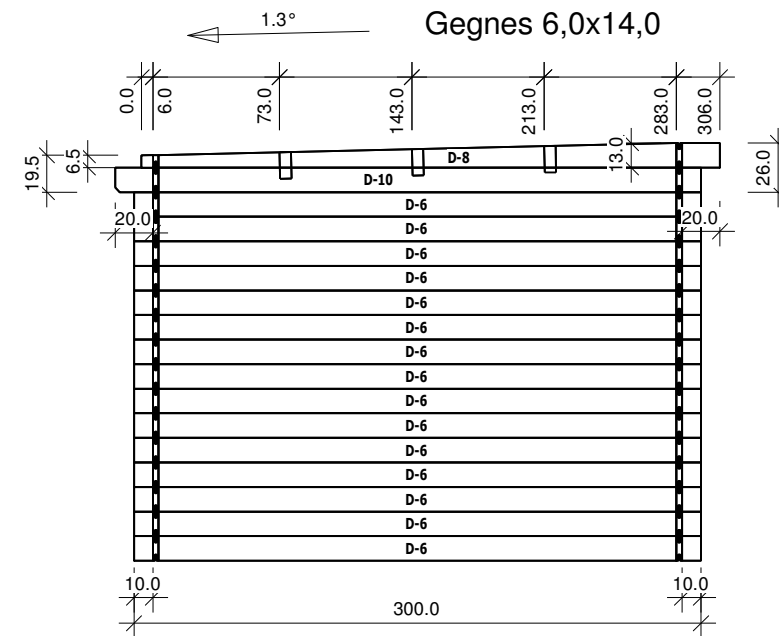

| Nr | H | L | Psc |
|----|----|------|----------|
| D | 6 | 13.0 | 300.0 15 |
| D | 8 | 13.0 | 306.0 1 |
| D | 10 | 13.0 | 310.0 1 |
| | | | 17 |