

Steven-4035

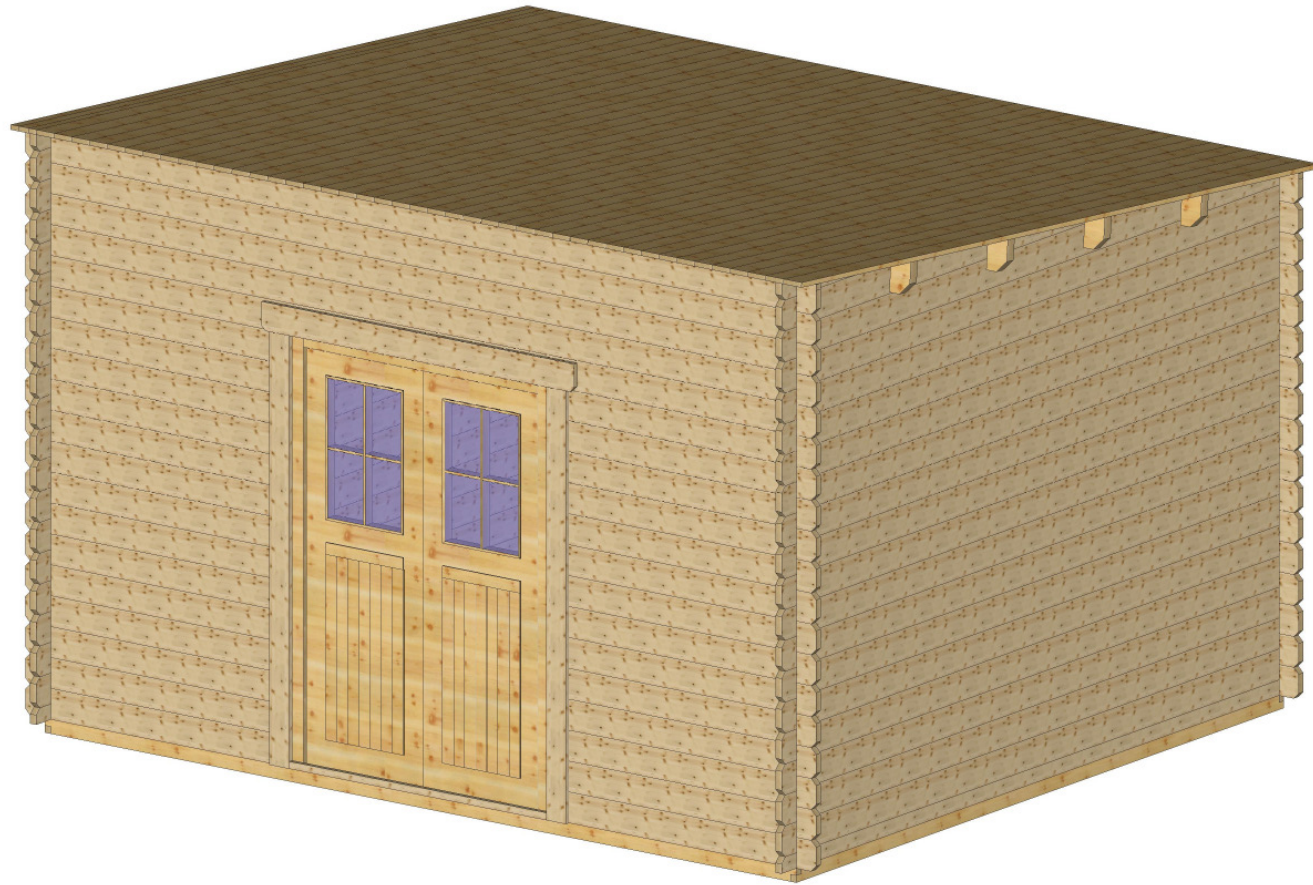

Bemerkung: die Ansicht von Turen, Fenster und anderen Teilen kann abweichen von diesem Bild



3,0

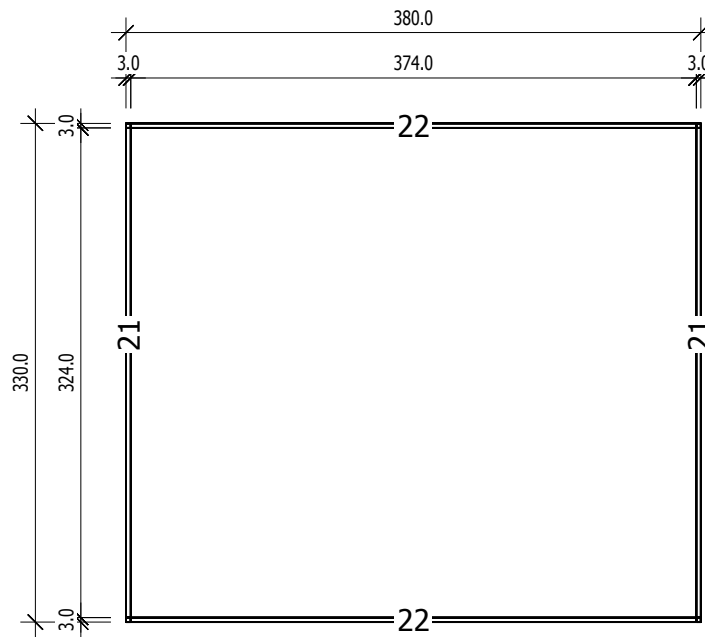
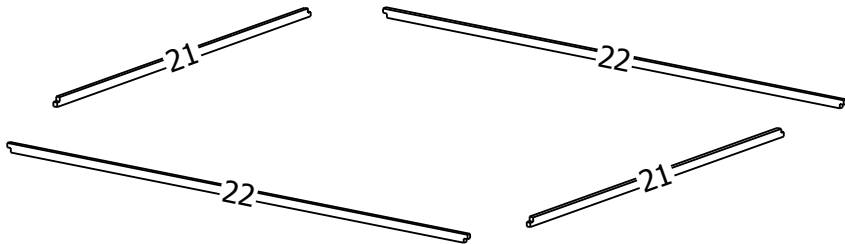
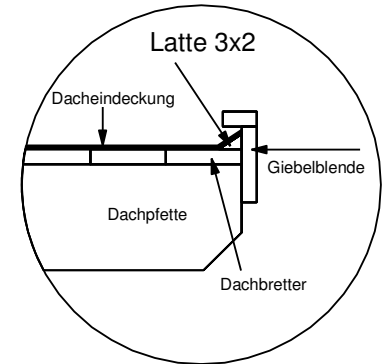
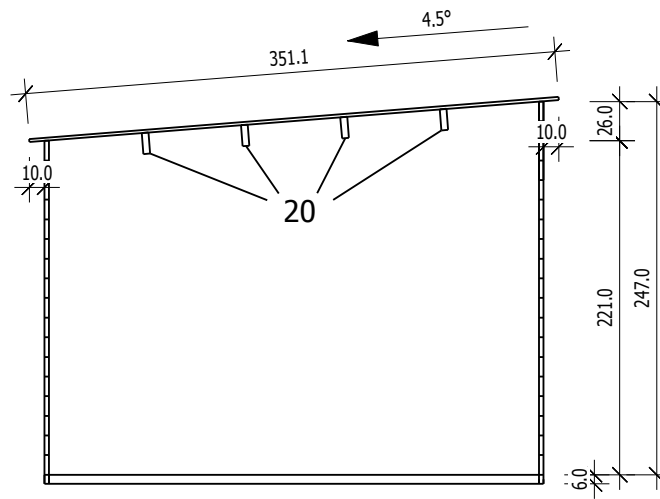
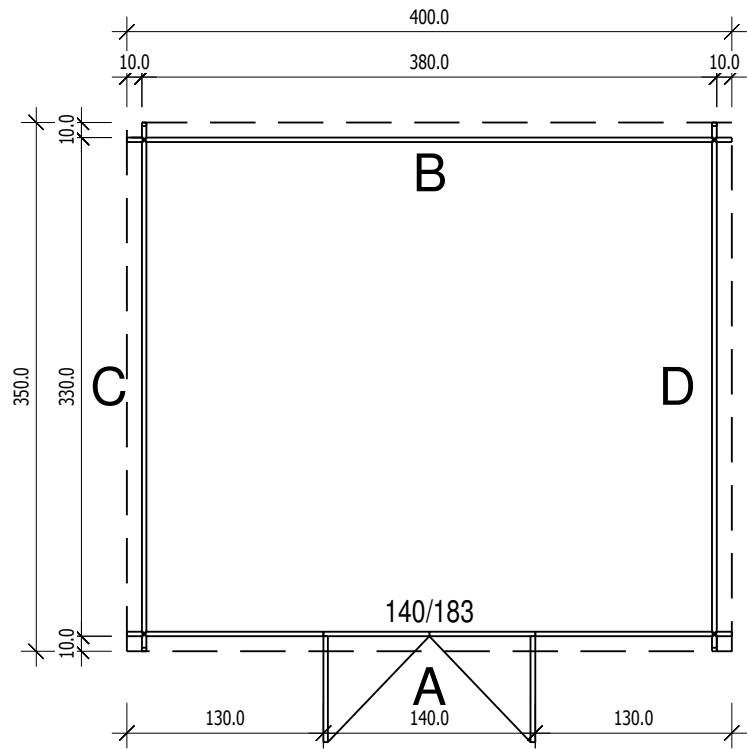

Nr.	B [cm]	H [cm]	L [cm]	Psc
21	3,0	6,0	330,0	2
22	3,0	6,0	380,0	2

	Nr	H	L	Psc
A	3	13.0	130.0	28
A	12	13.0	400.0	3
A	13	13.0	400.0	1
A	14	13.0	400.0	1

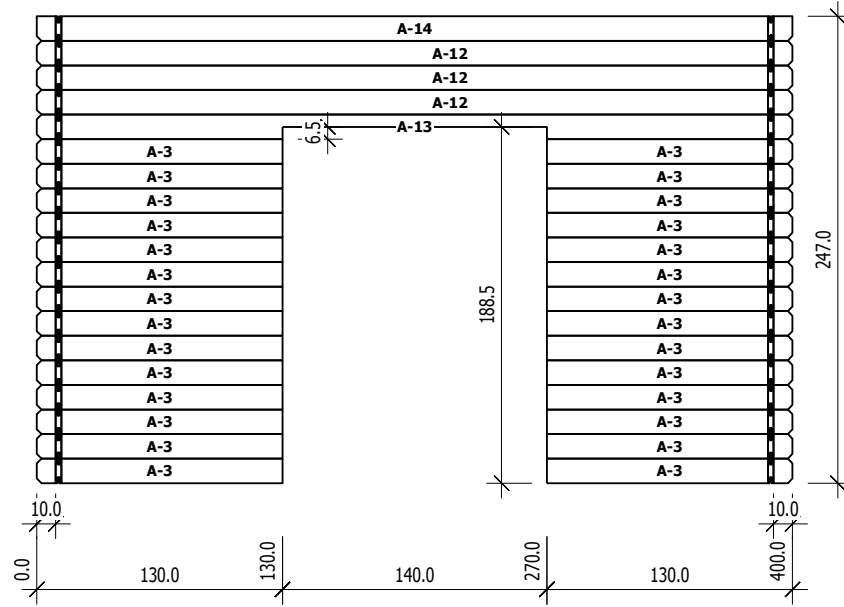

B
M 1:40

	Nr	H	L	Psc
B	15	13.0	400.0	16
B	16	13.0	400.0	1

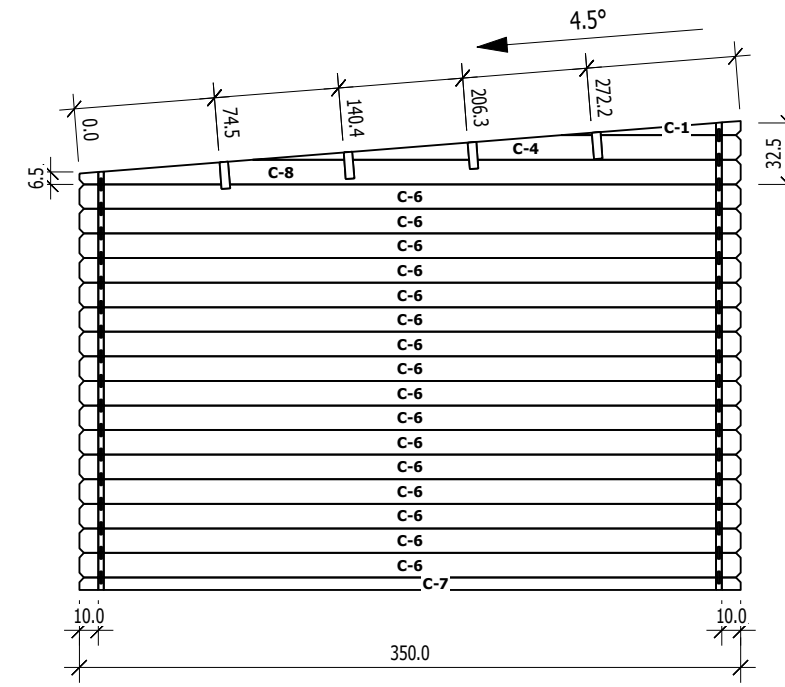
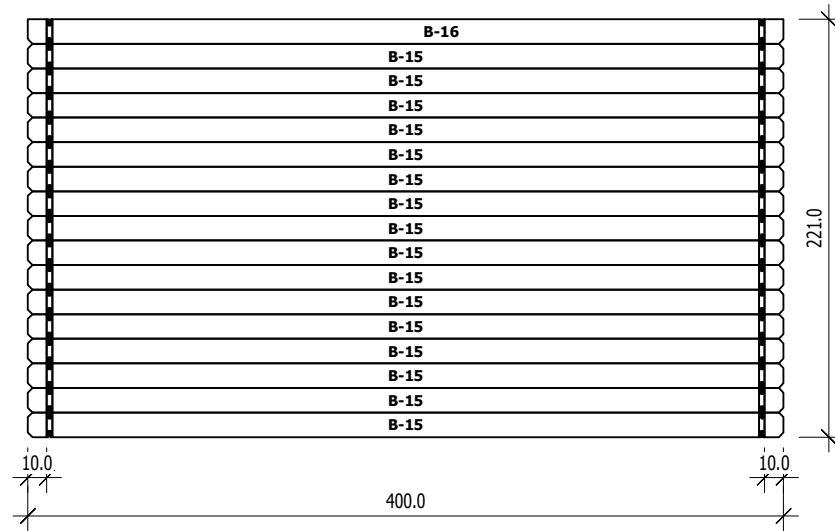

	Nr	H	L	Psc
C	1	7.5	94.8	1
C	4	13.0	258.3	1
C	6	13.0	350.0	16
C	7	6.5	350.0	1
C	8	13.0	350.0	1

D
M 1:40

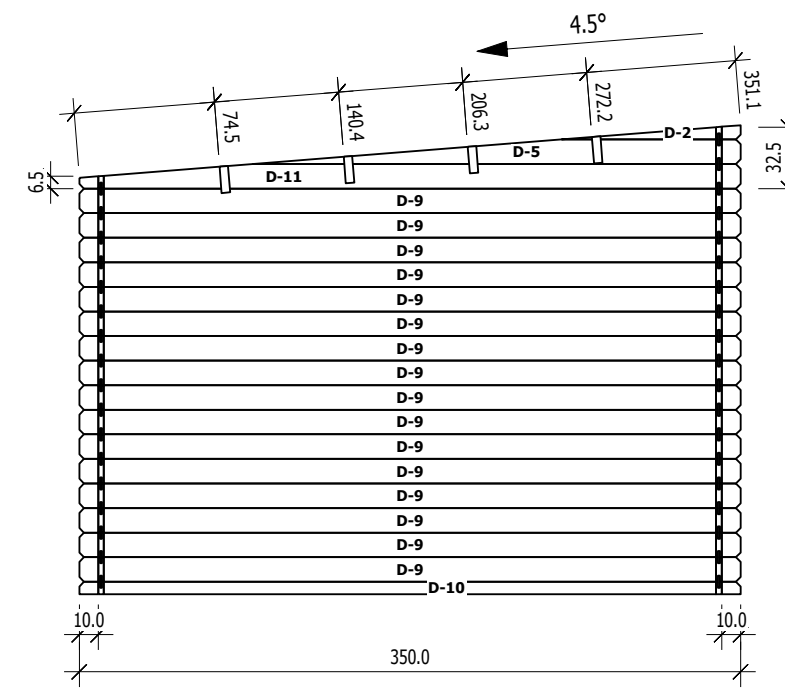

	Nr	H	L	Psc
D	2	7.5	94.8	1
D	5	13.0	258.3	1
D	9	13.0	350.0	16
D	10	6.5	350.0	1
D	11	13.0	350.0	1