

Steven-3040



Bemerkung: die Ansicht von Turen, Fenster und anderen Teilen kann abweichen von diesem Bild



3,0

Grundriss

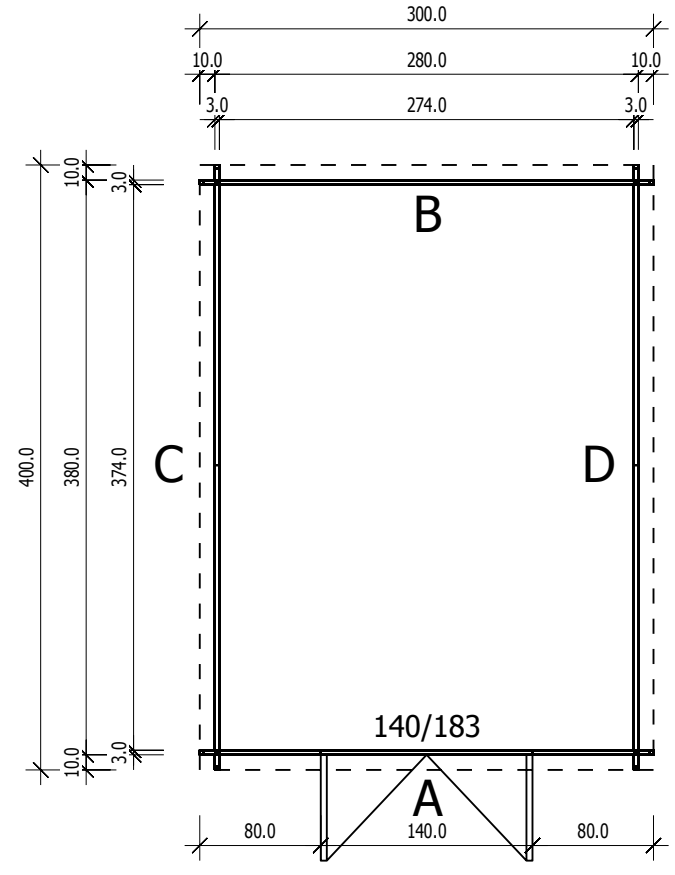

Schnitt

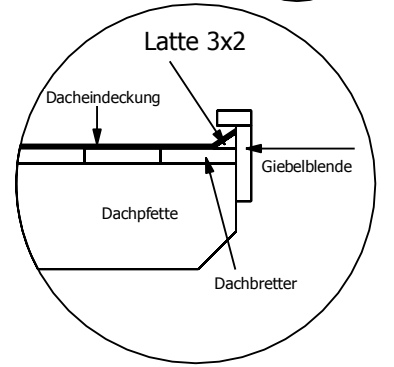
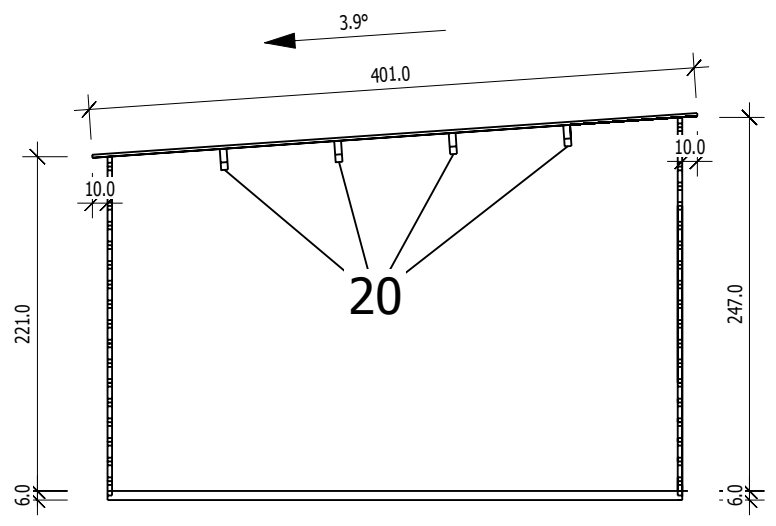

Grundrahmenplan

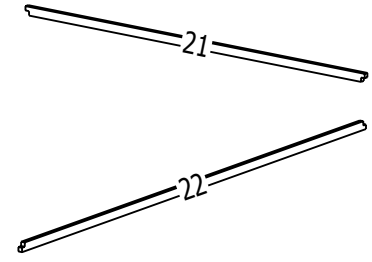
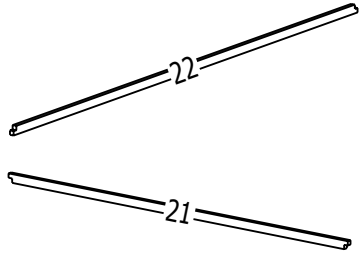
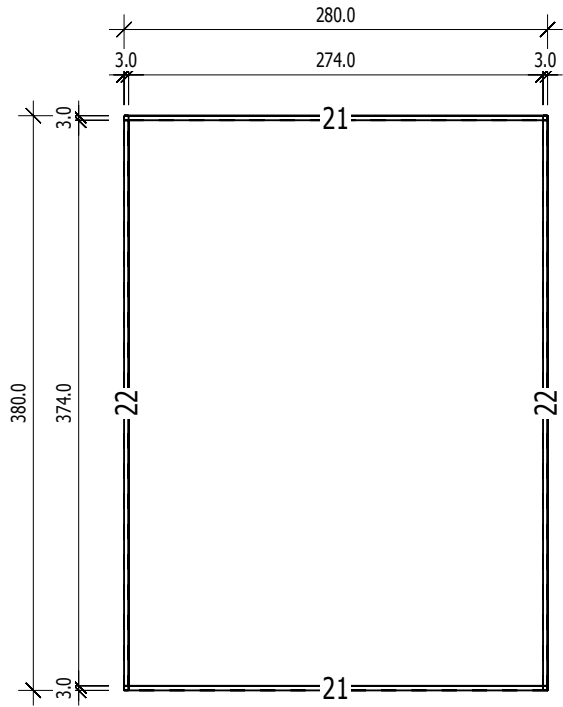

3,0

A
M 1:40

	Nr	H	L	Psc
A	1	13.0	80.0	28
A	2	6.5	80.0	2
A	5	13.0	300.0	1
A	6	13.0	300.0	3
A	7	6.5	300.0	1

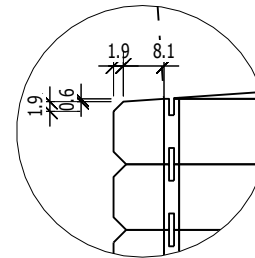
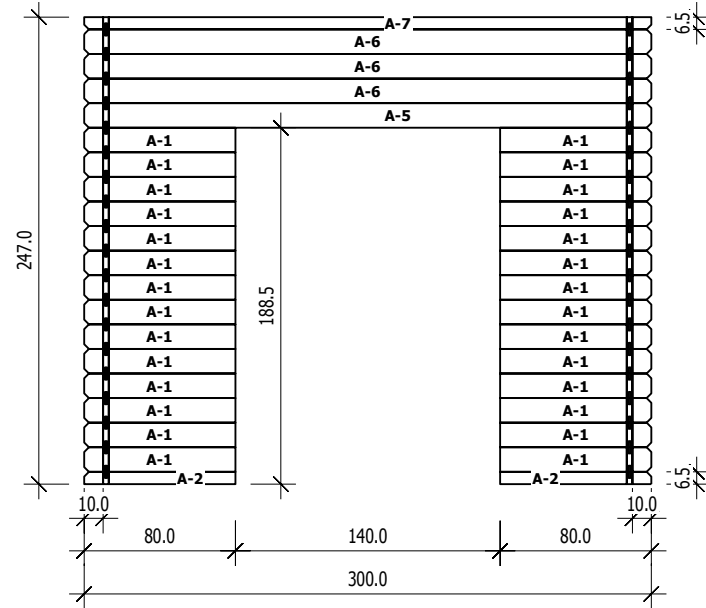

B
M 1:40

	Nr	H	L	Psc
B	8	13.0	300.0	16
B	9	6.5	300.0	1
B	10	6.5	300.0	1

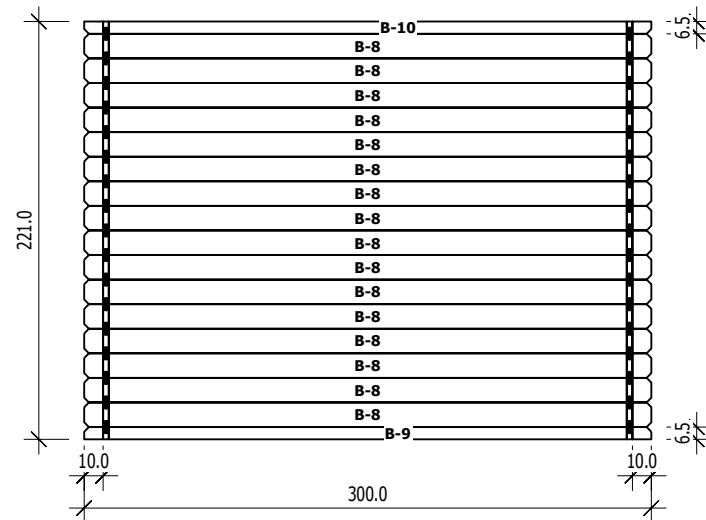

C
M 1:40

	Nr	H	L	Psc
C	3	13.0	201.5	1
C	11	13.0	388.0	1
C	13	13.0	400.0	16
C	14	13.0	400.0	1

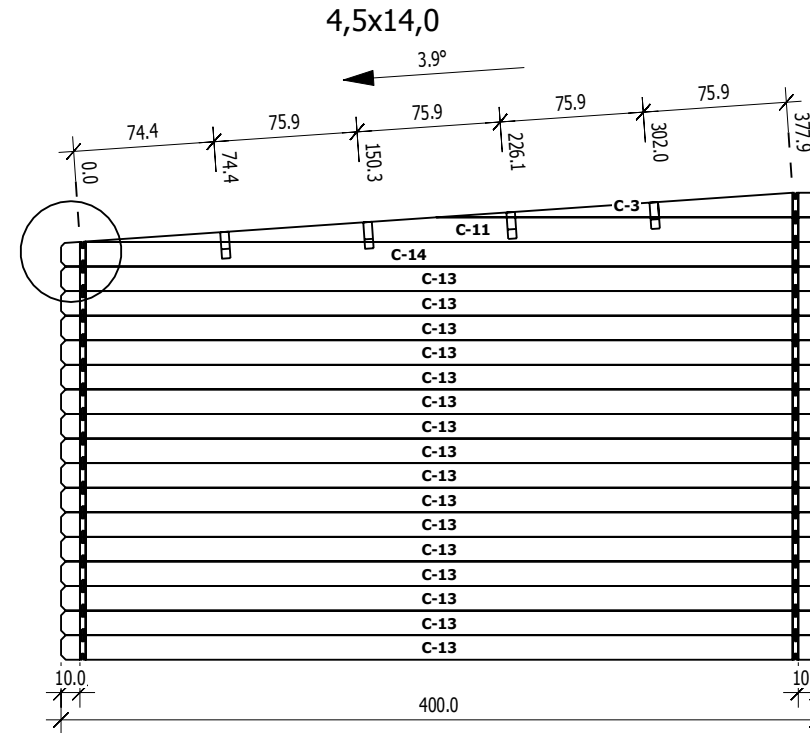

D
M 1:40

	Nr	H	L	Psc
D	4	13.0	201.5	1
D	12	13.0	388.0	1
D	15	13.0	400.0	16
D	16	13.0	400.0	1

