

Bemerkung: die Ansicht von Türen, Fenster und anderen Teilen kann abweichen von diesem Bild

# Grundriss

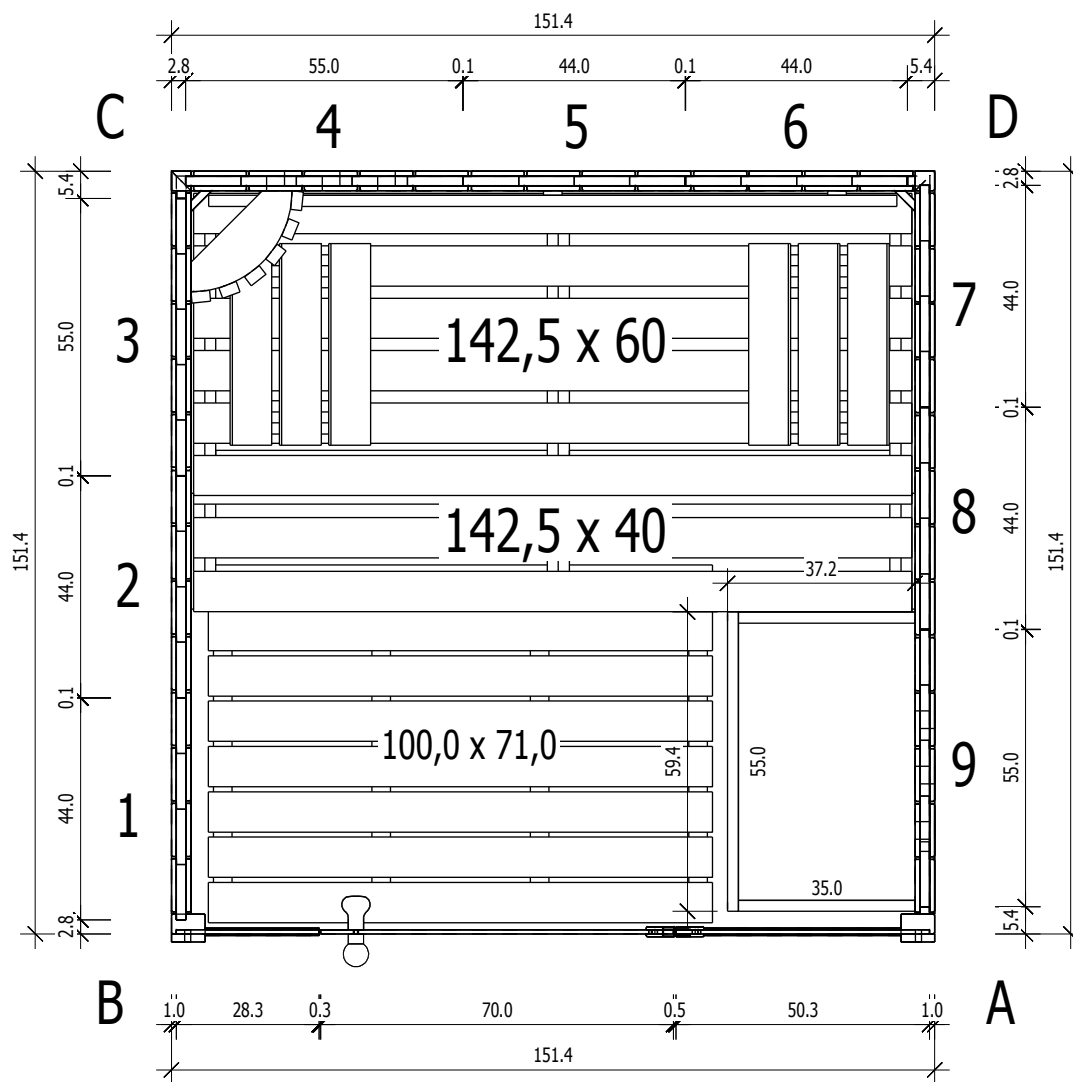

# Schnitt

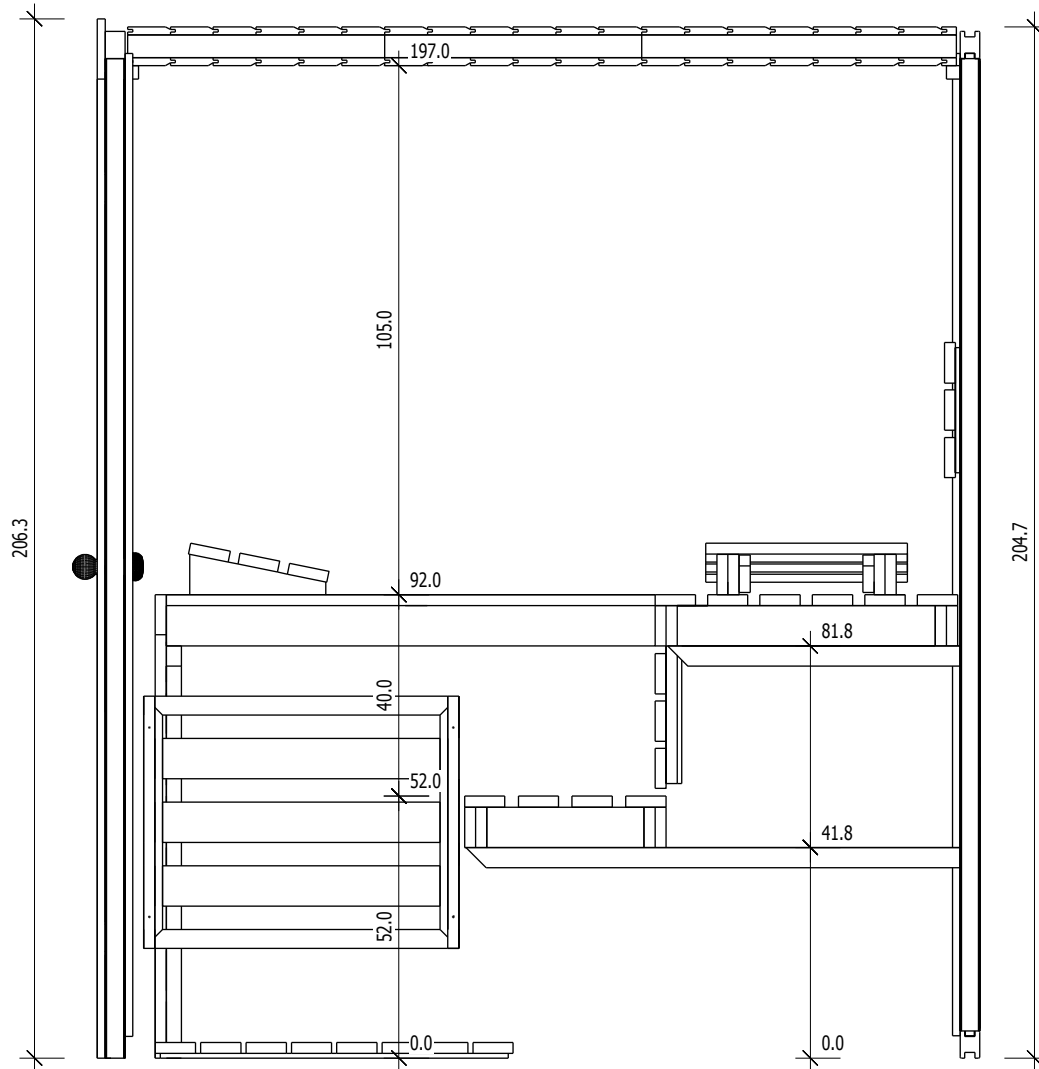

# Glaswand

Aluminis profilis

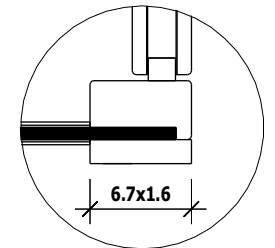
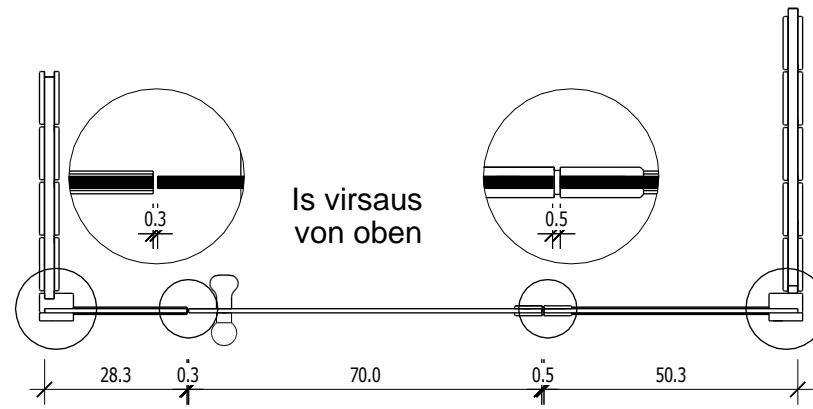
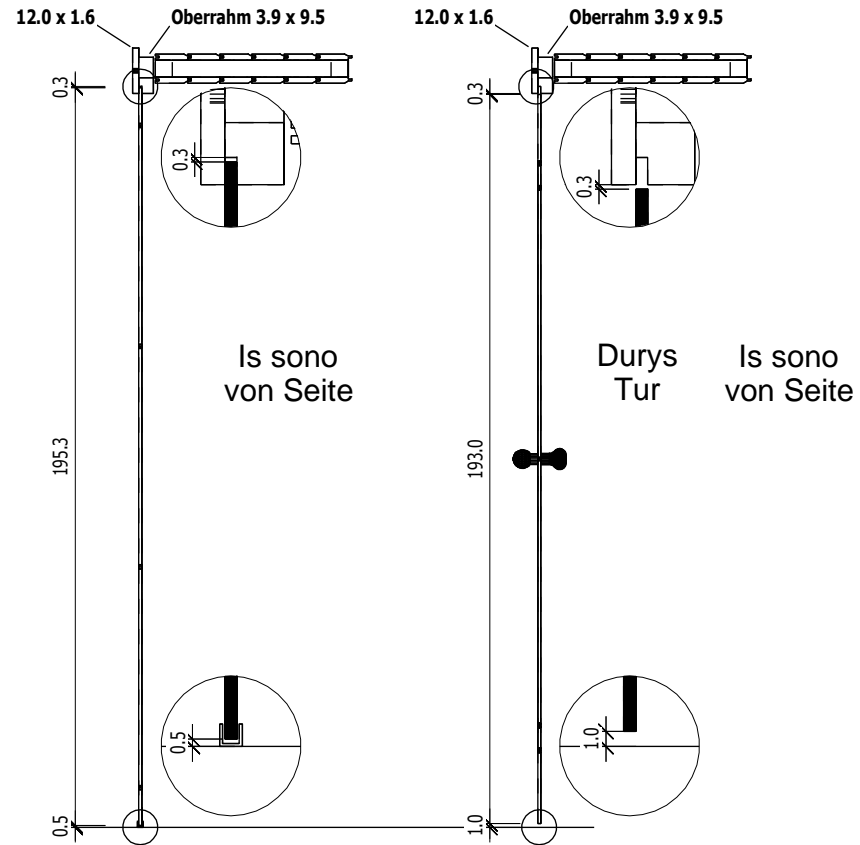
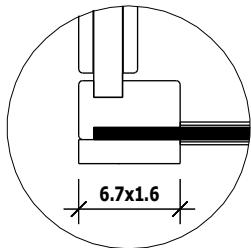
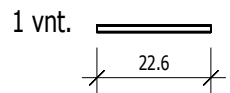
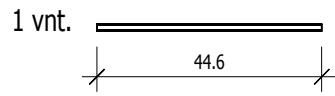
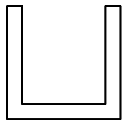

# Grundrahmen

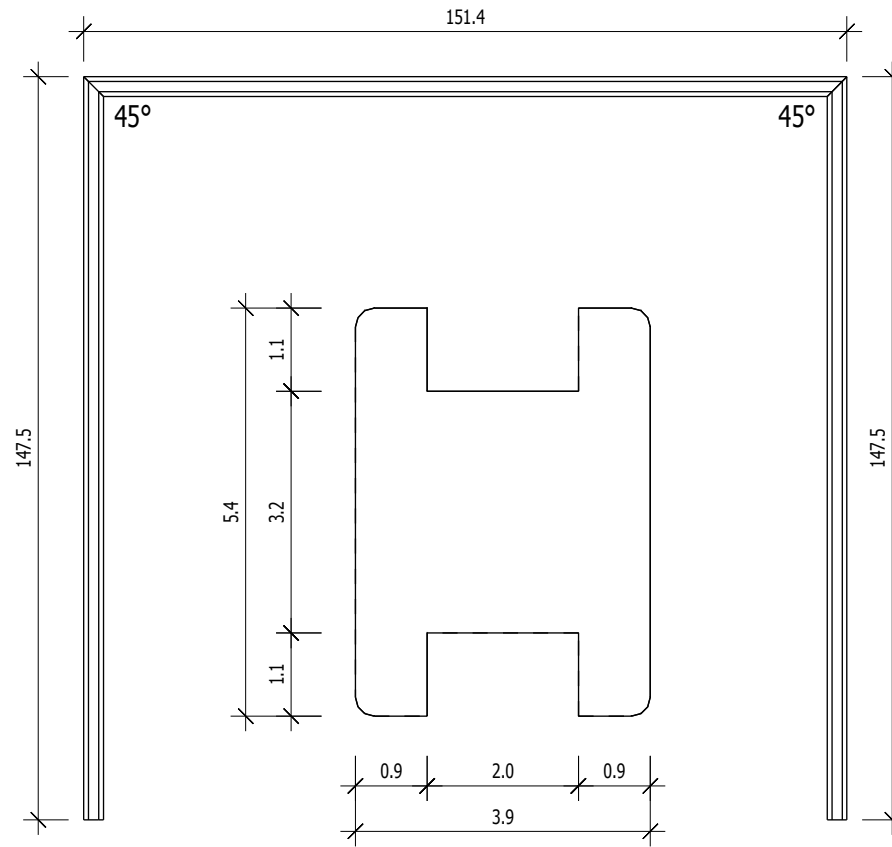

# Oberrahm

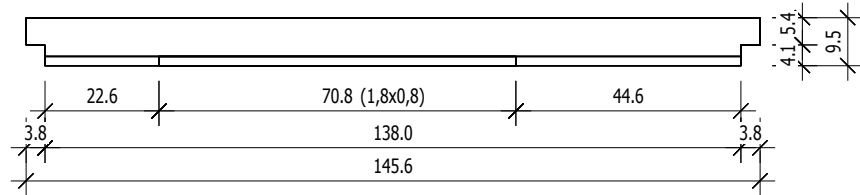
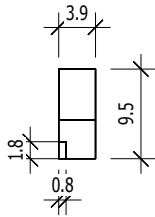
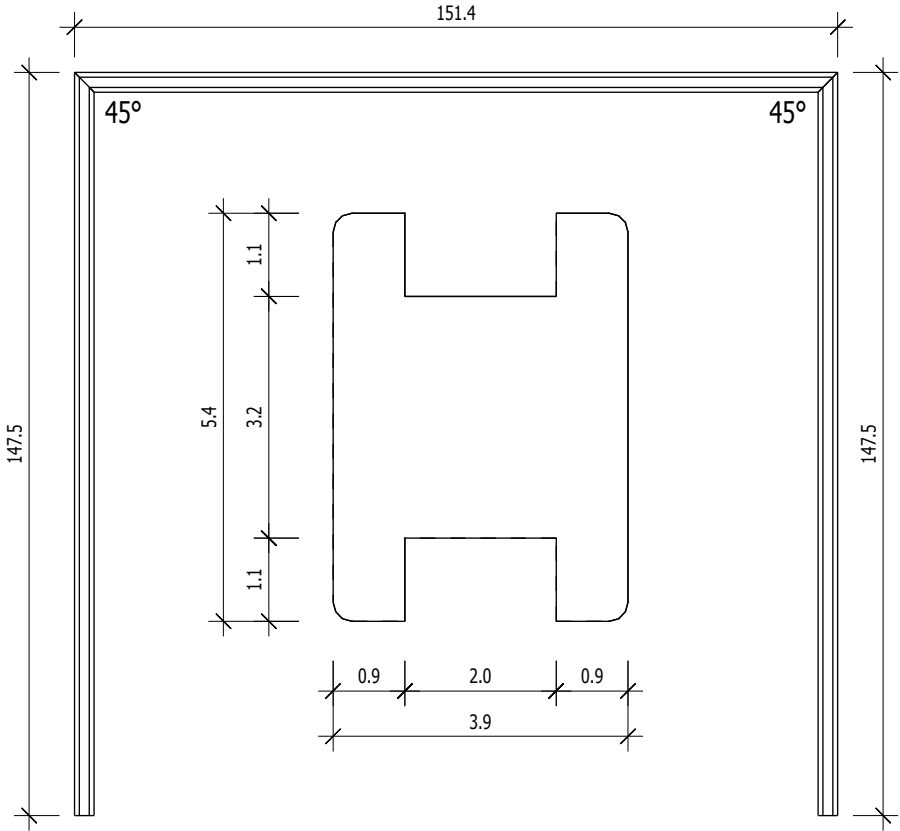

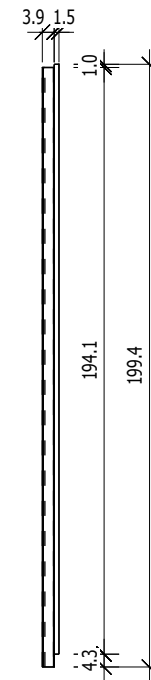
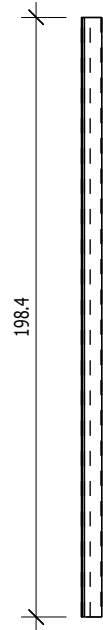
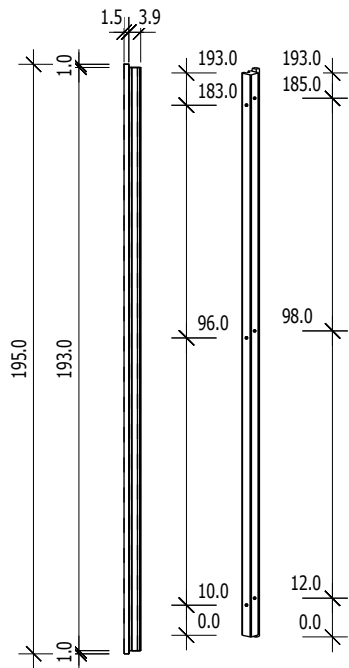
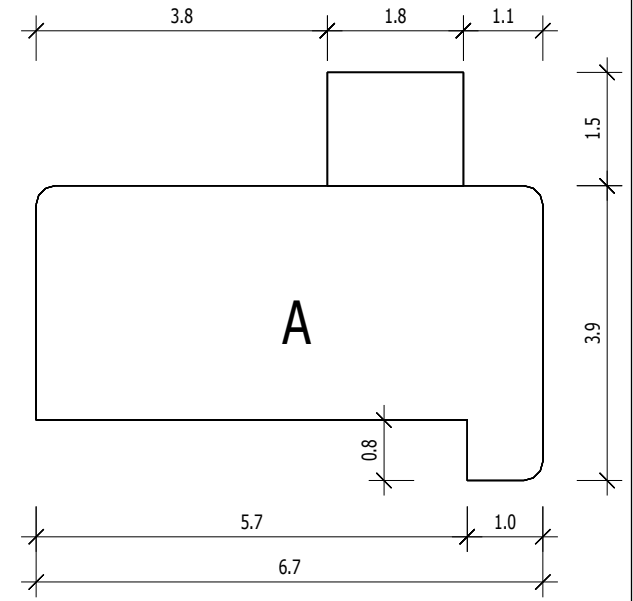
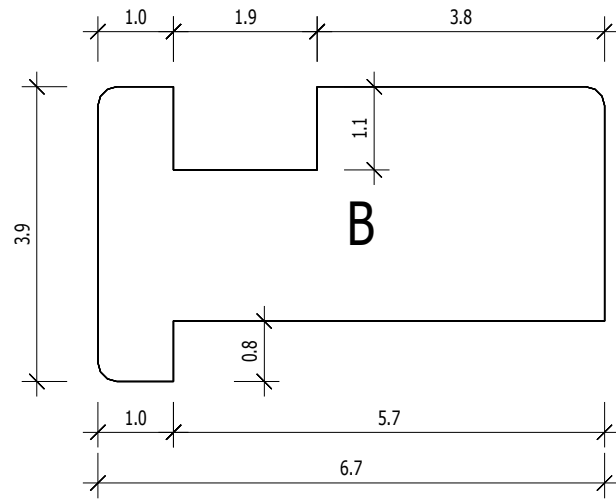
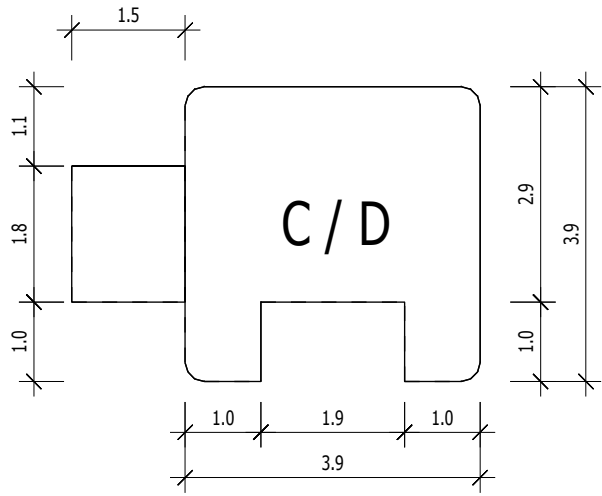

# Wandelemente

Nr. 3;

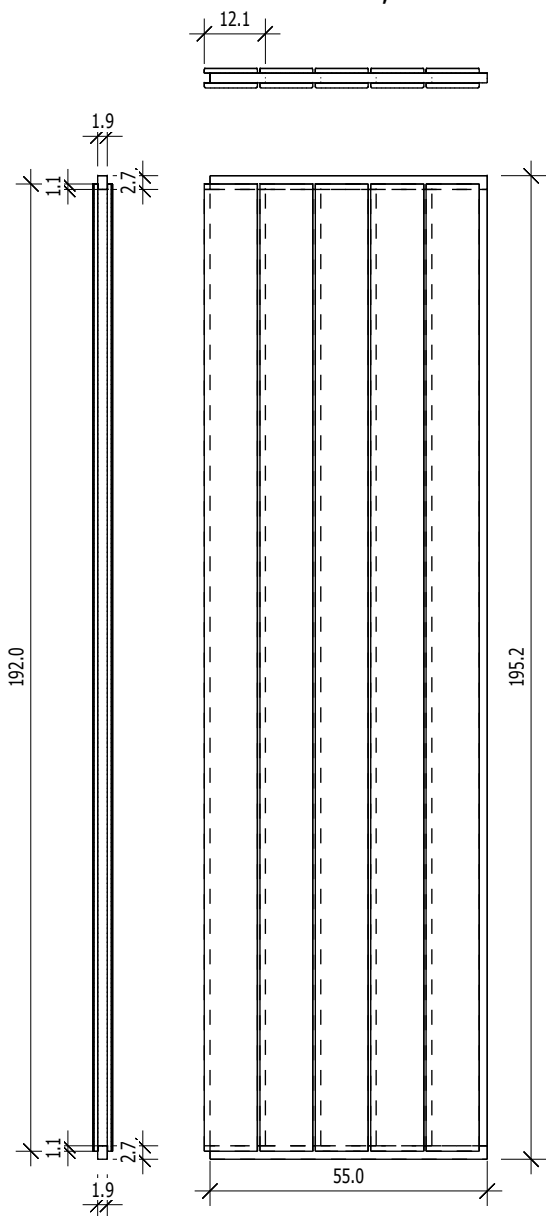

Nr. 4;

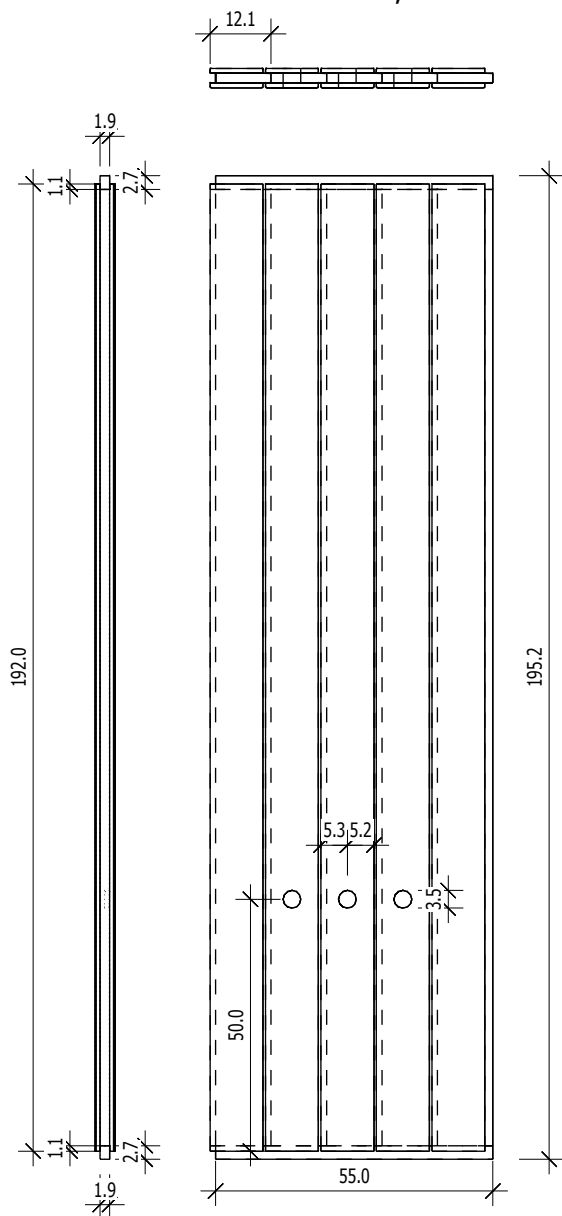

Nr. 9;

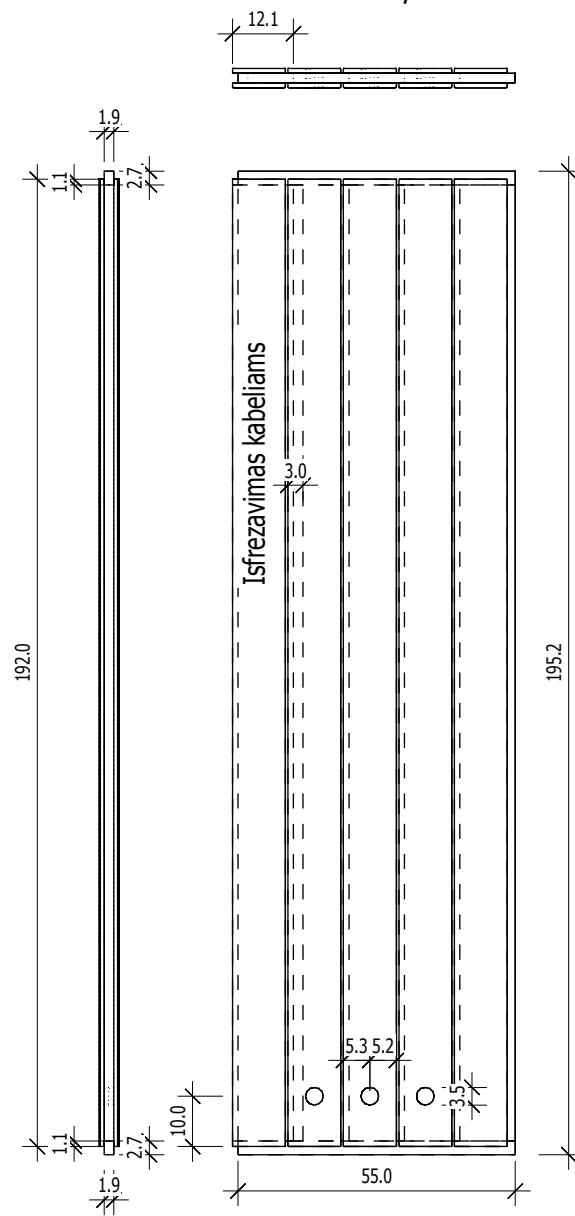



# Wandelemente

Nr. 1;2;5;6;7;8;

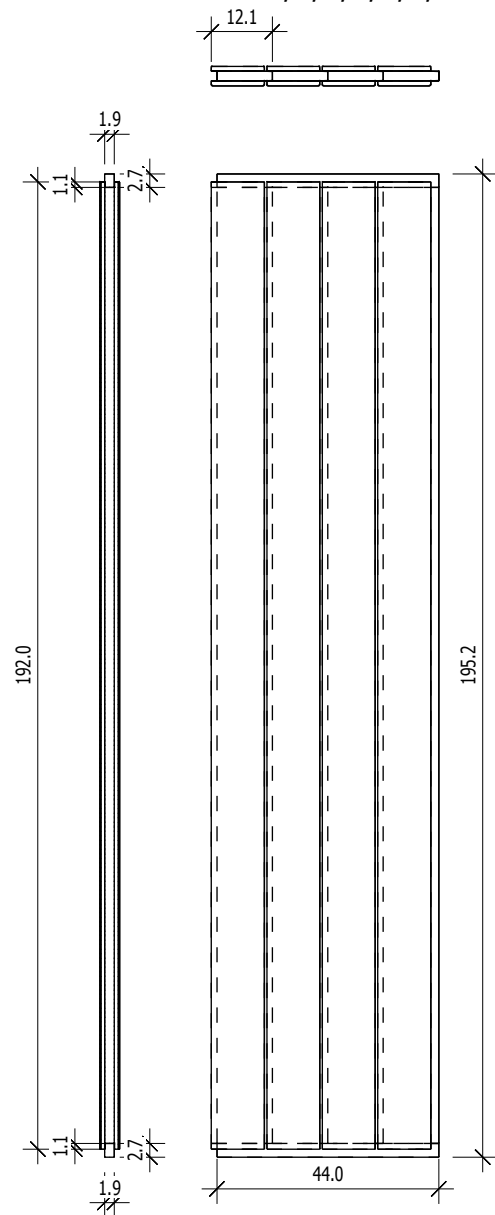

# Dachelemente

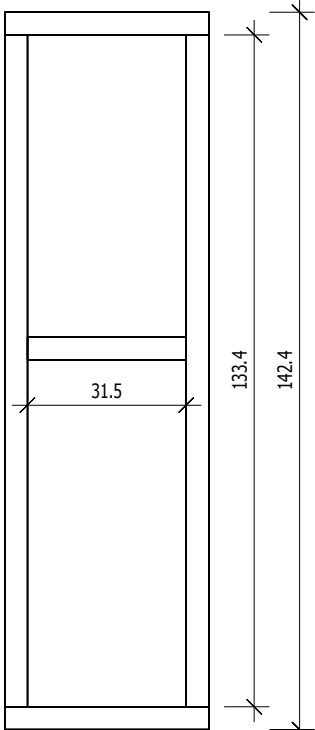
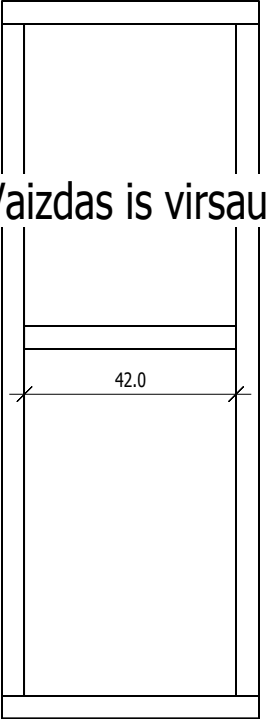
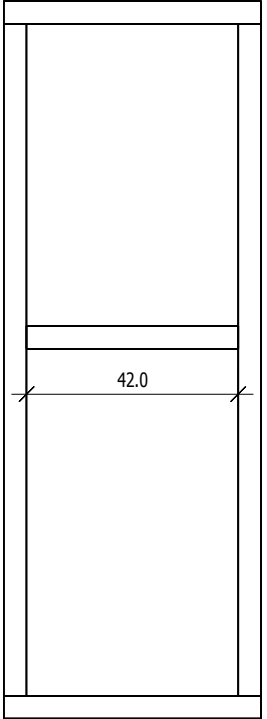
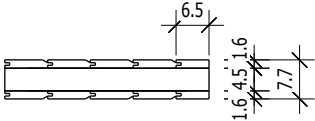
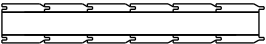

Vaizdas is virsaus

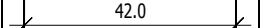
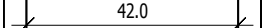
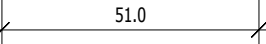
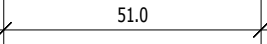

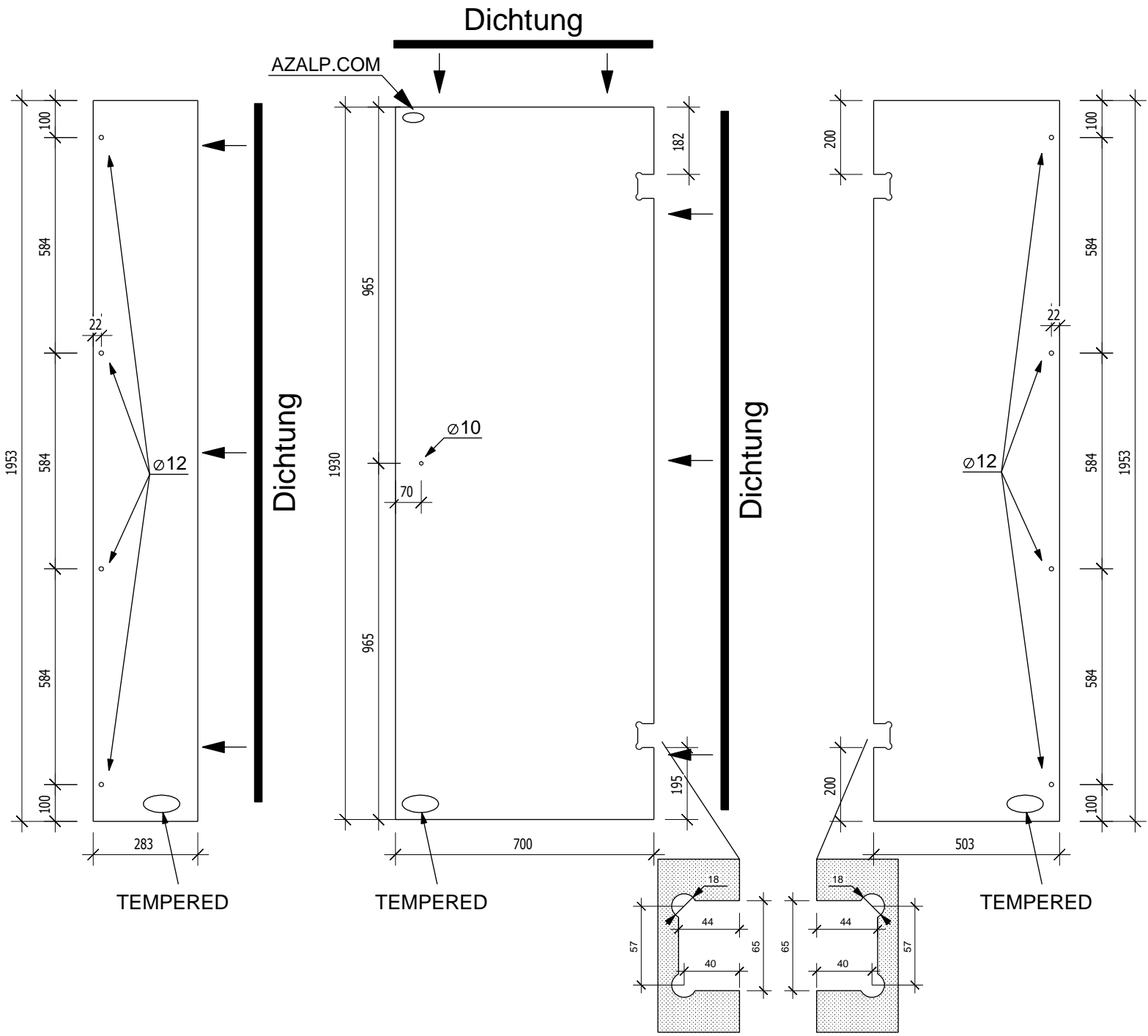

**Montageanweisung**  
**Glas an Glas-Stoßdichtung**  
**transluzent für 8 mm Glasscheiben**  
**Art.-Nr. 85055**

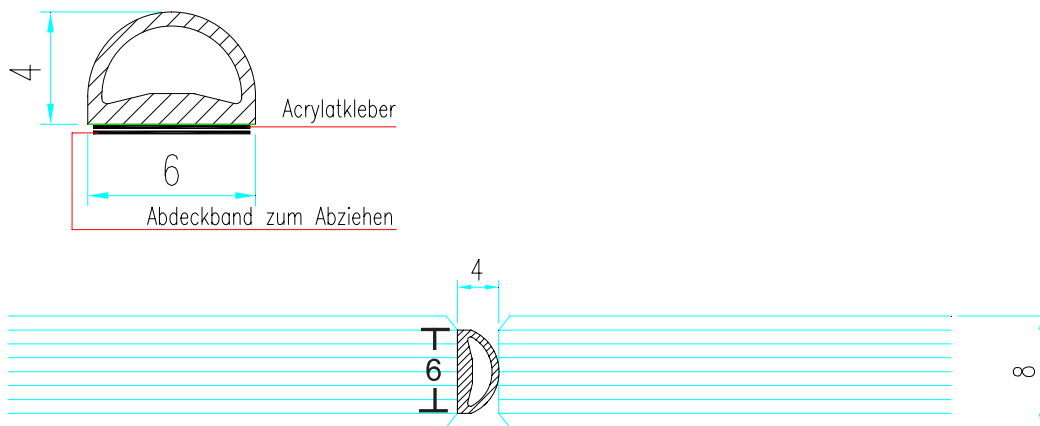

Material TPE, Einsatzbereich -40 °C bis 110 °C, witterungs-, ozon- und UV-beständig

**Montage**

1. Reinigung der Flächen; 2. Abdeckband - entfernen  
3. Aufrollen der Dichtung; 4. Trocknungszeit min. 12h

12 bis 24 Stunden