

Paviljon 4355 / 28 / 3

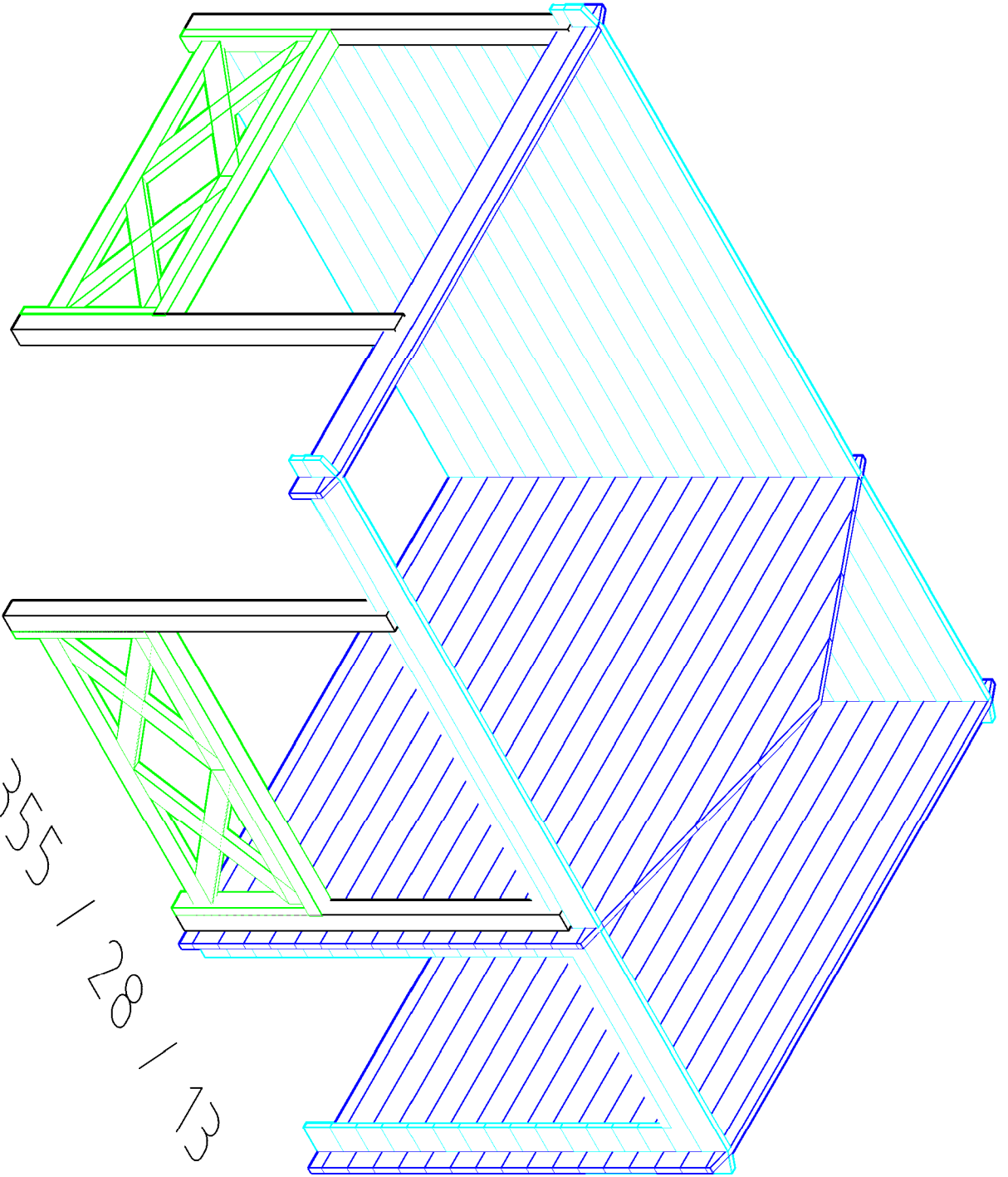

Paviljon 4355 / 28 / 13

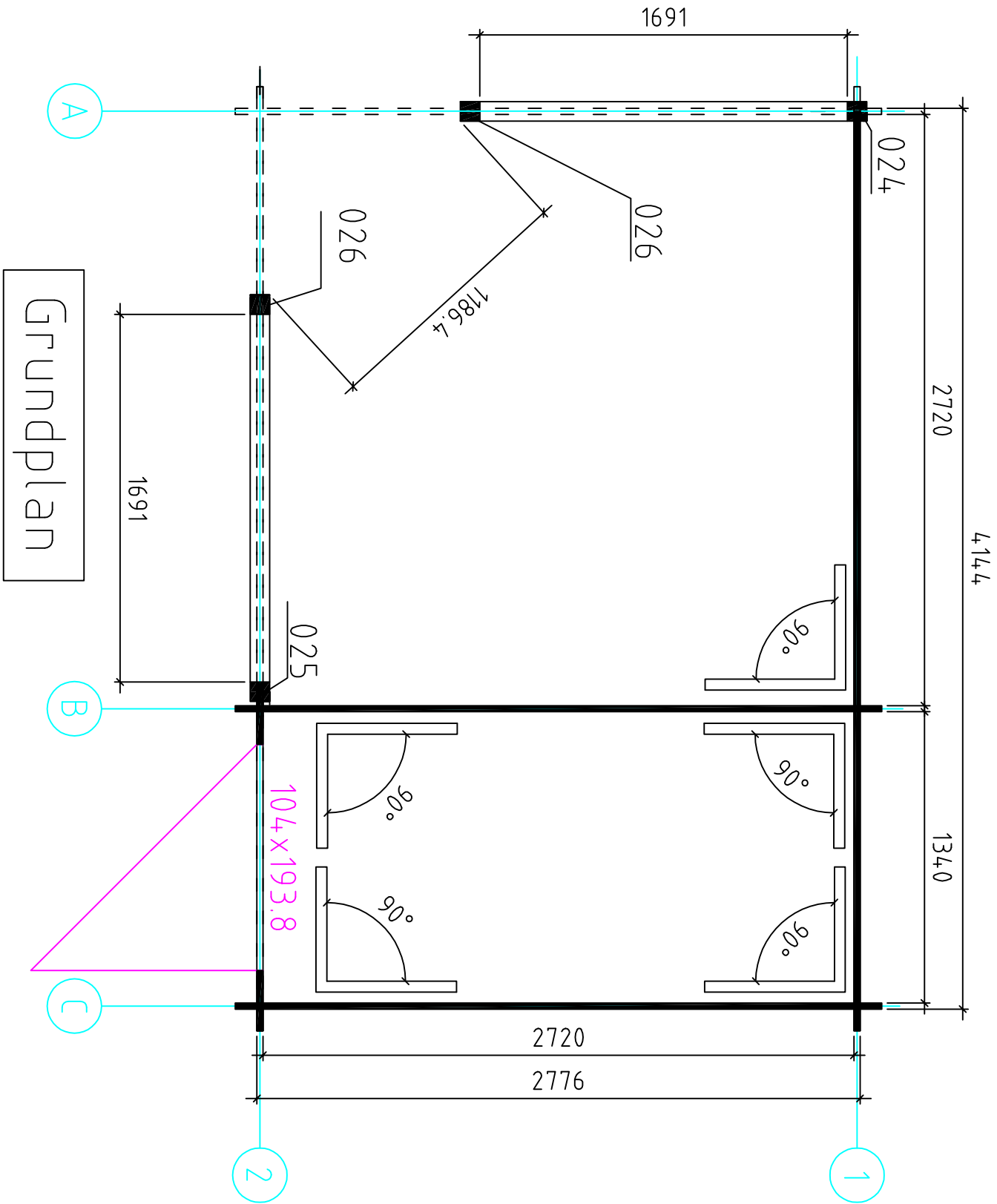

Grundplan

Schraubenlocher
vorbereiten !!!!!



Schrauben 5x120

Wand A

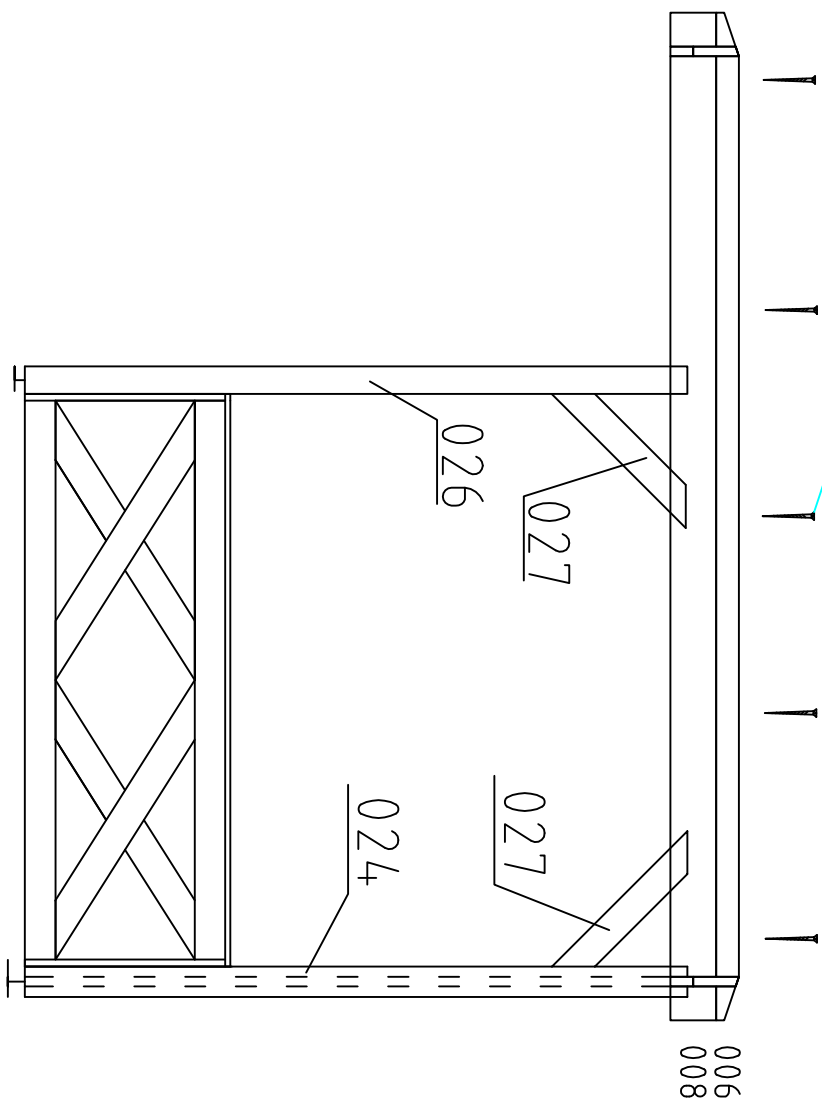

Paviljon 4355 / 28 / 13

Schraubenloch
 vorbereiten !!!!!

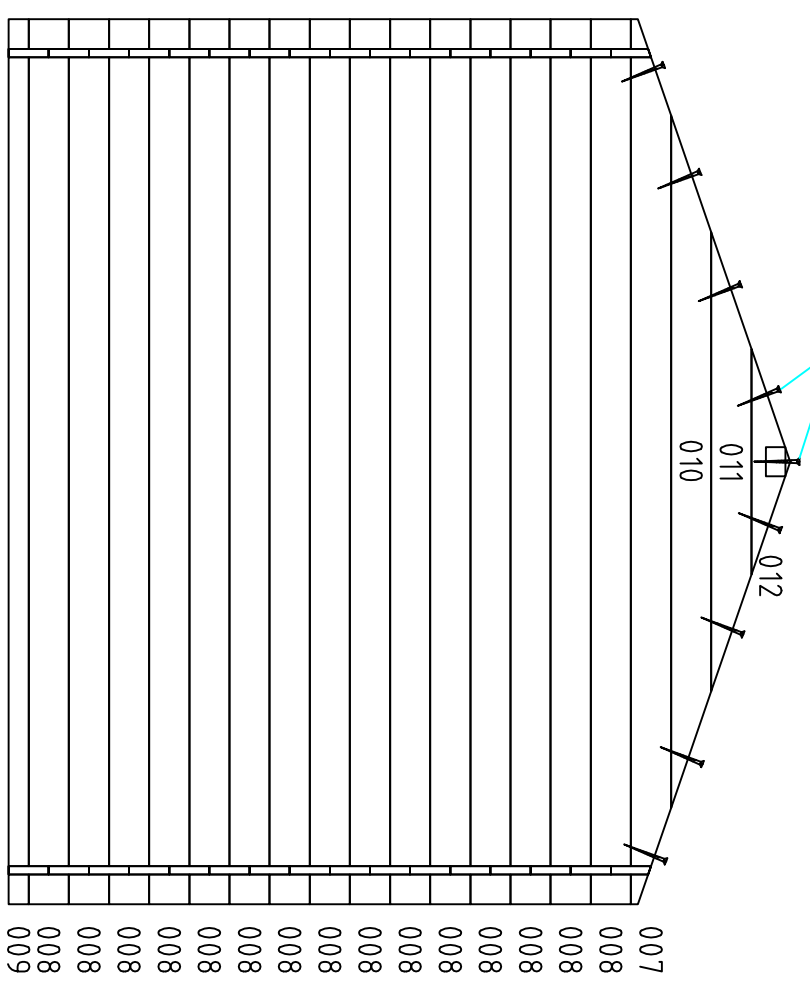
 Schrauben
 6x130

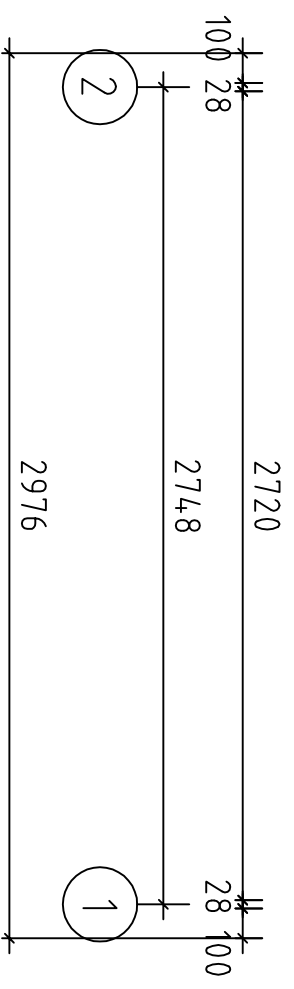

Wand B



Paviljon 4 355 / 28 / 13



Schraubenlocher
vorbereiten !!!!!

Schrauben 5x120

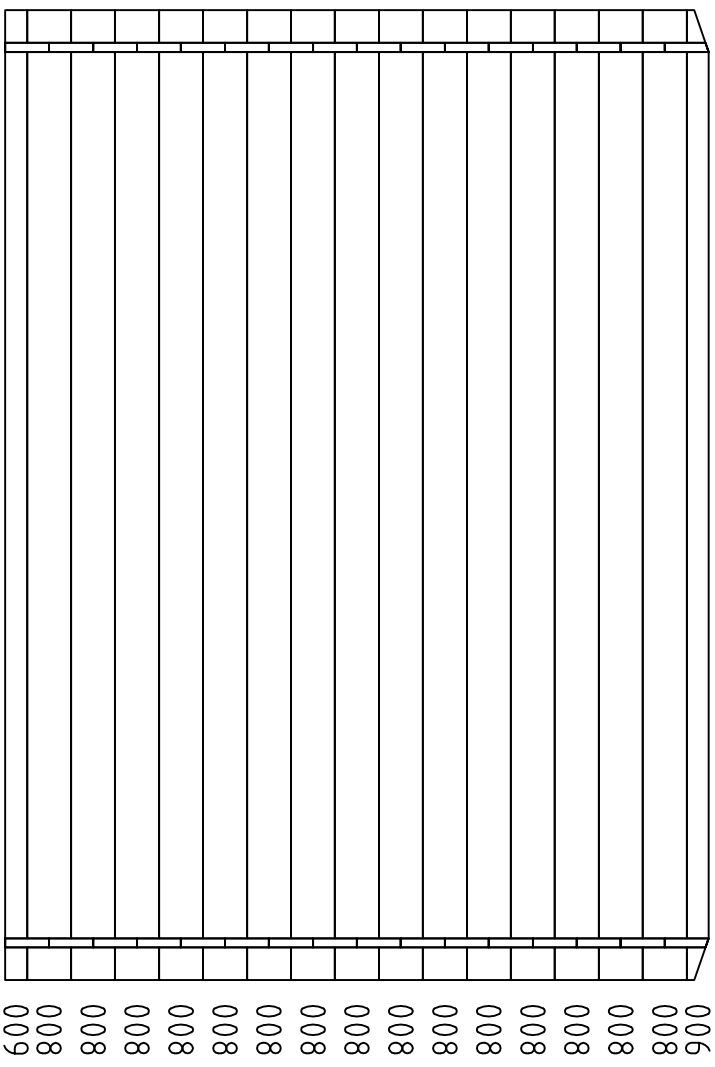

Wand C

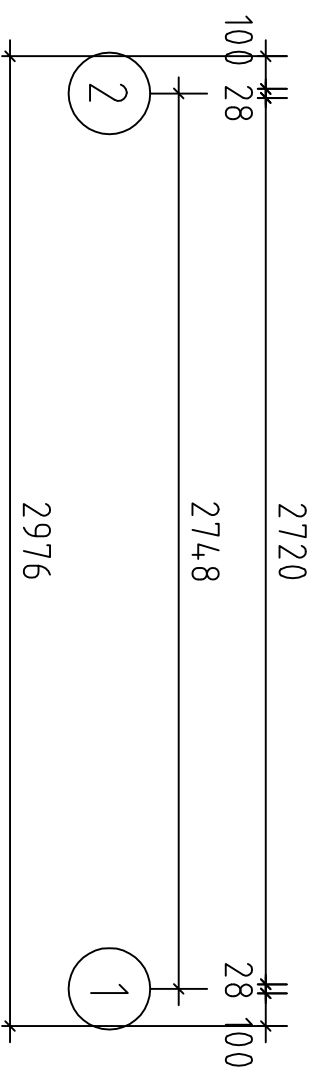

Paviljon 4.355 / 28 / 13

Wand 2 ↗

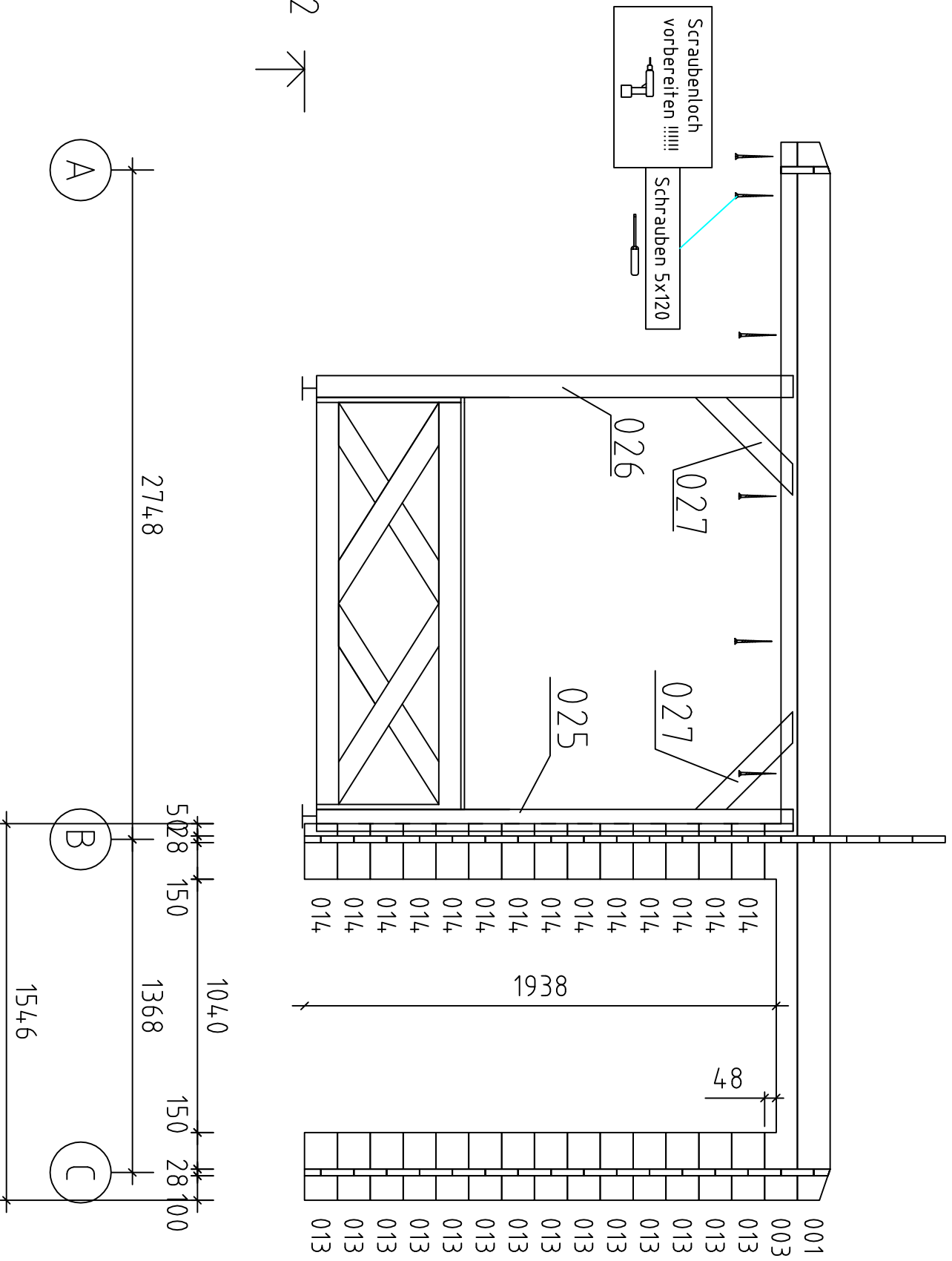

Paviljon 4355 / 28 / 13

Wand 2 

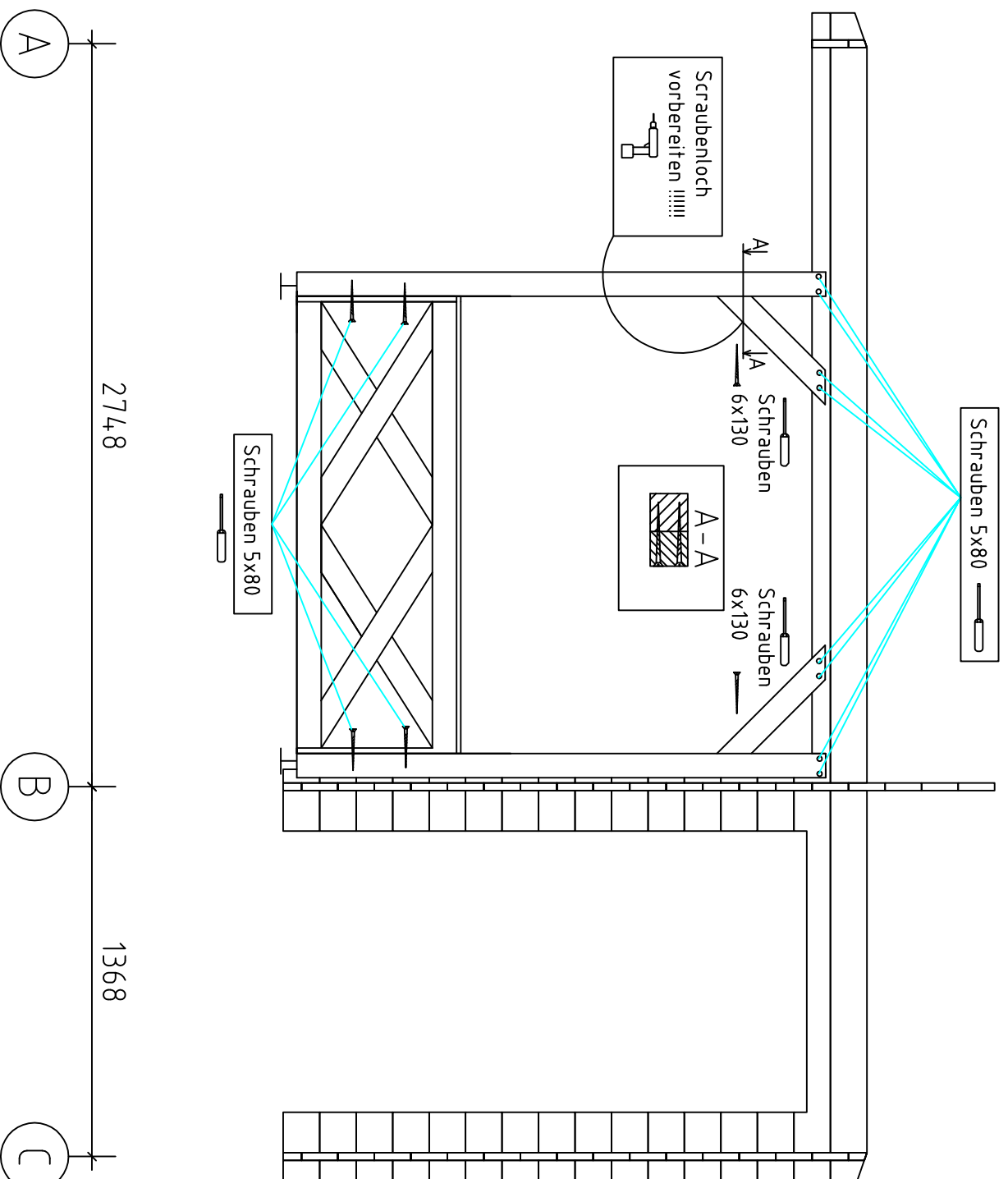

Paviljon 4.355 / 28 / 13

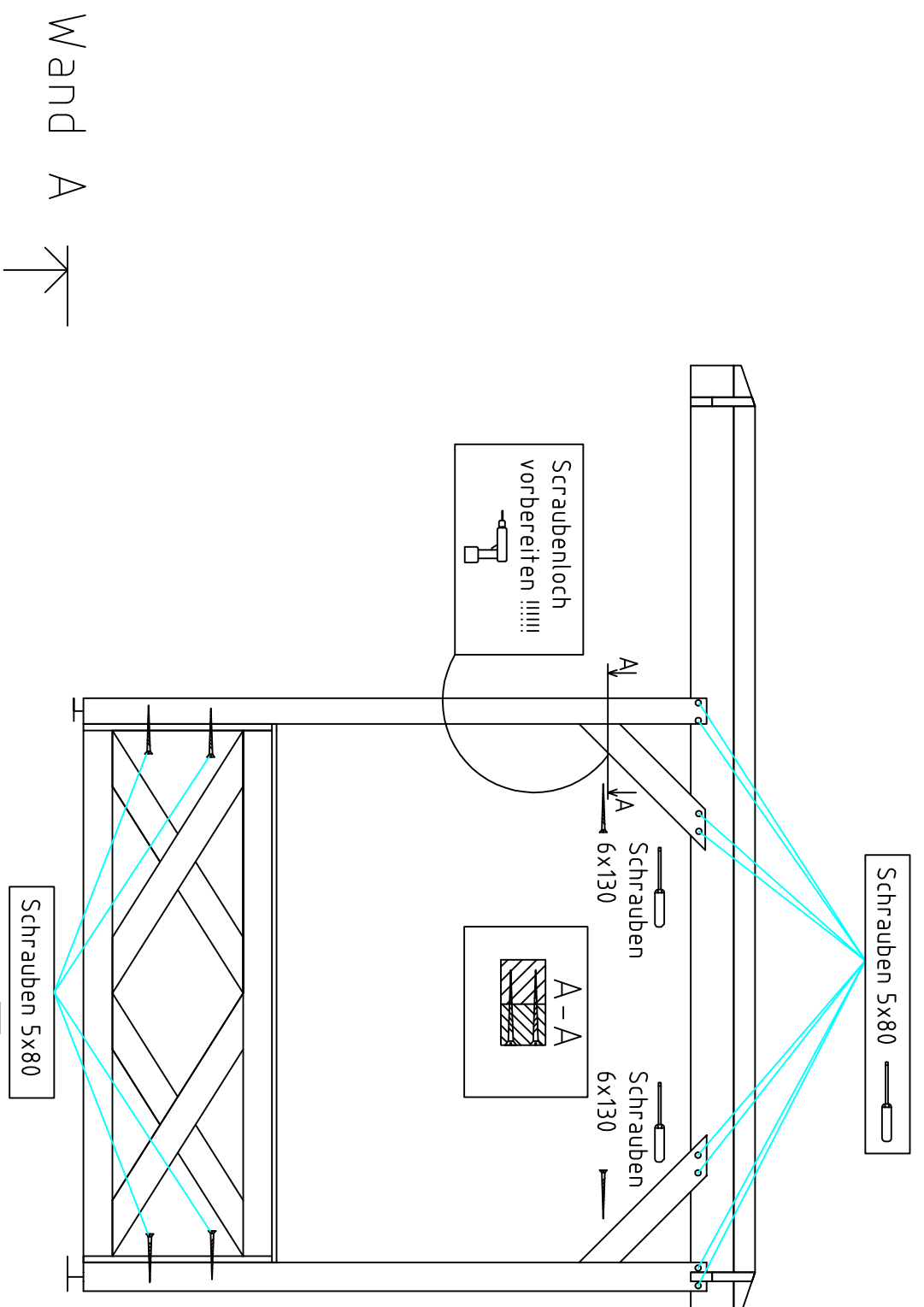

Wand A

2 2748 1
Paviljon 4355 / 28 / 13

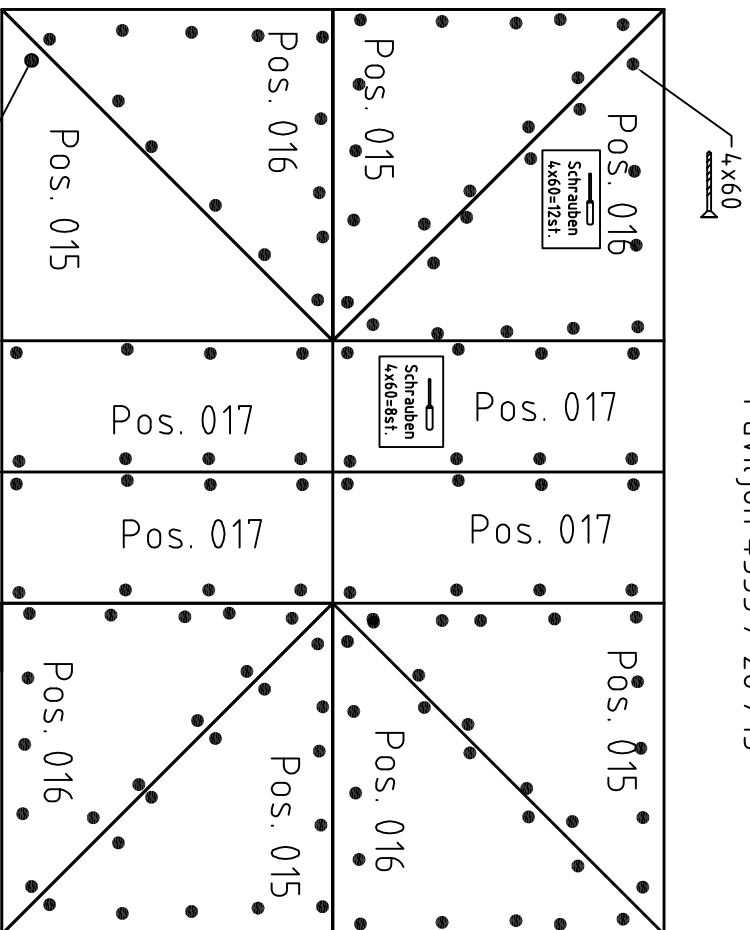

Paviljon 4355 / 28 / 13

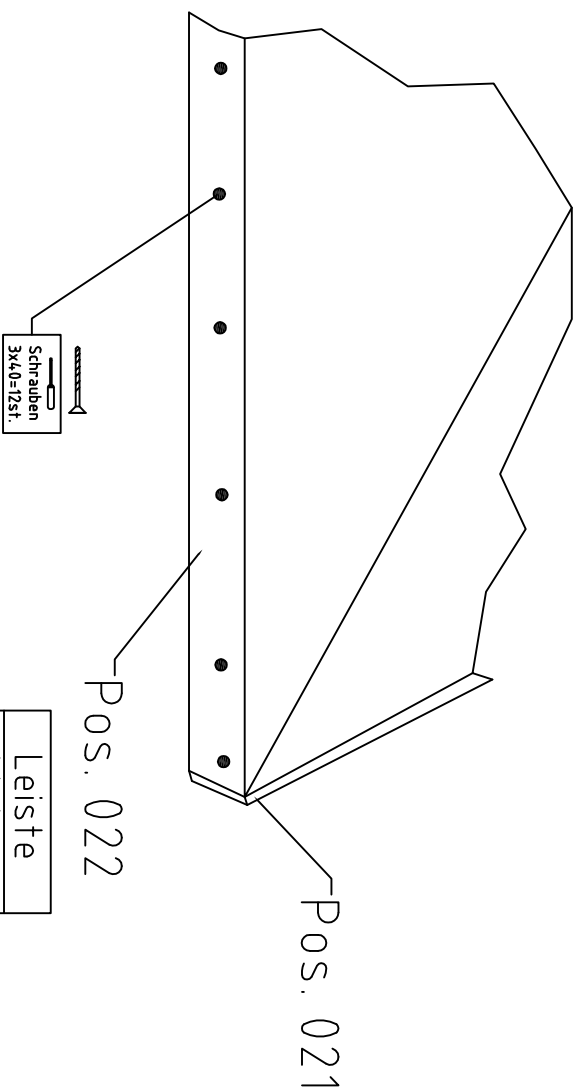

Dachelement
Roofelement
Dakelement

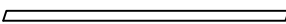
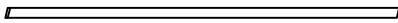
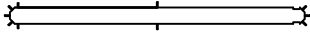
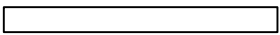
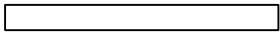
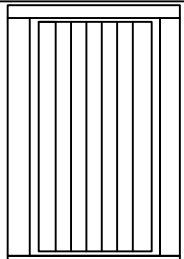
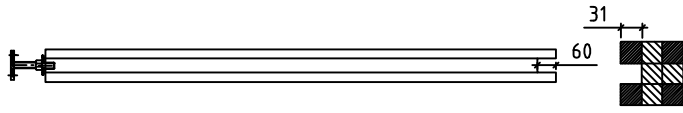
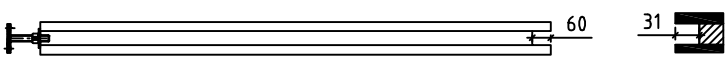
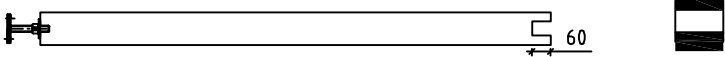
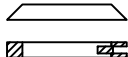
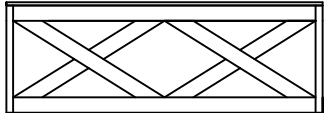
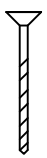
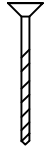
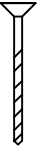
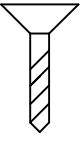
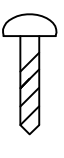
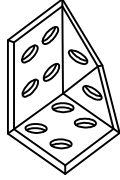
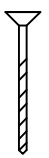
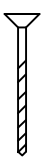

Leiste
List
Lijsten

Pos	Paviljon 4355 / 28 /13						ST	F (mm)	L (mm)
015	Dachelement Roofelement Dakelement 						4	1595x1685	
016	Dachelement Roofelement Dakelement 						4	1595x1685	
017	Dachelement Roofelement Dakelement 						4	690x1695	
018	Dachbalken Roofbeam Dakbalken 						6	40x58	1408
019	Dachbalken Roofbeam Dakbalken 						4	40x58	1941
020	Dachbalken Roofbeam Dakbalken 						1	97x65	1465
021	Leiste List Lijsten 						2	20x70	3400
022	Leiste List Lijsten 						2	20x70	4800
023	Tür Door Deur 1040x1938 						1R		
024	Pfosten 						1	90x90	1960
025	Pfosten 						1	90x90	1960
026	Pfosten 						2	90x90	1960
027	Träger 						4	90x90	560
028	Barrieren 						2		1691
	3x40	5x80	5x120	5x16	5x16		4x60	6x130	
Beslag Beschlag Metalworks									
	70 st.	30st.	20 st.	16 st.	8 st.	4 st.	180 st.	20 st.	