

Paviljonen 3555 / 40 / 3

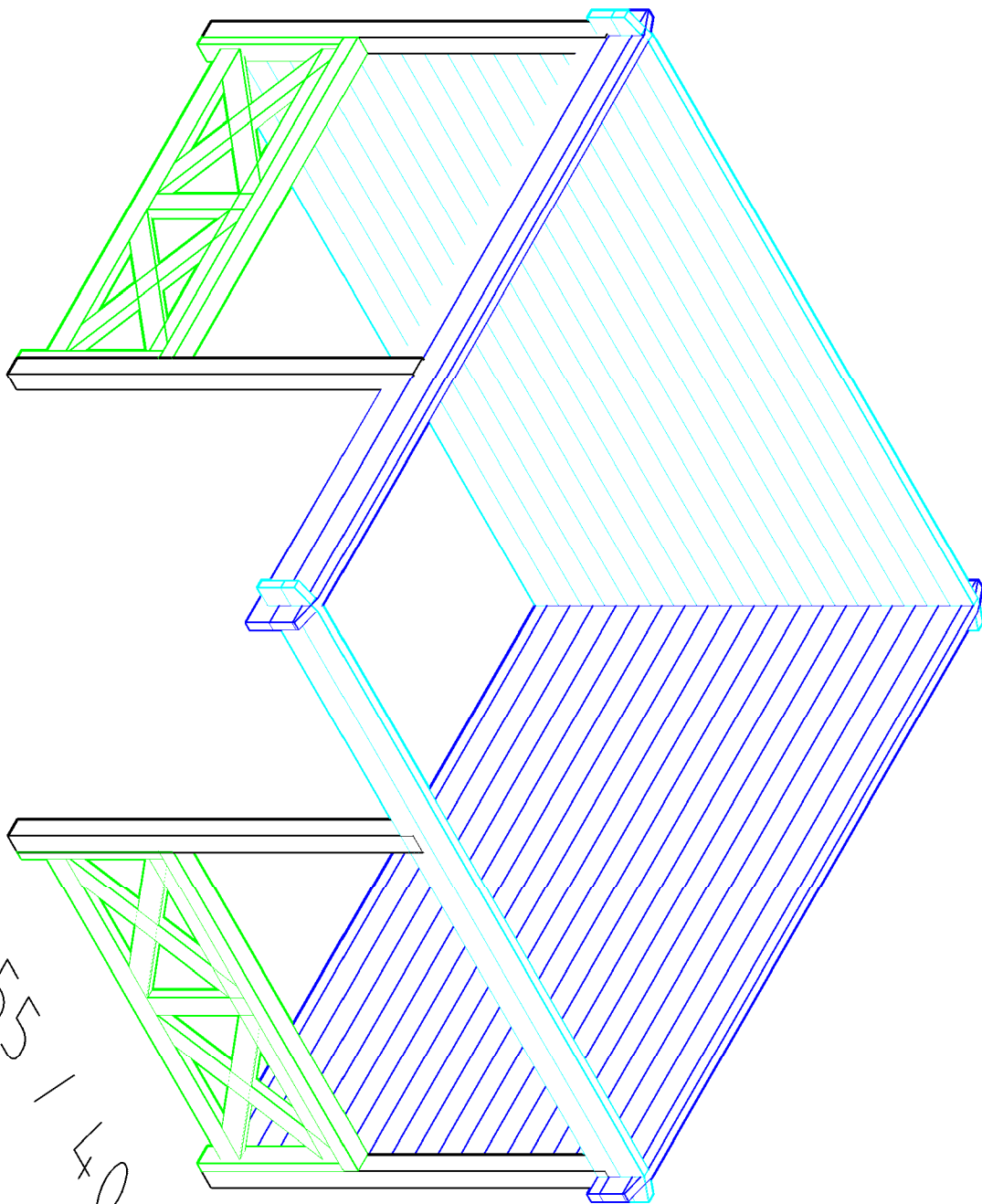

Paviljon 3555 / 40 / 13

3300

3220

1

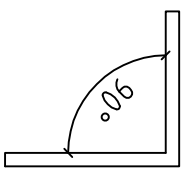

3220

3300

2

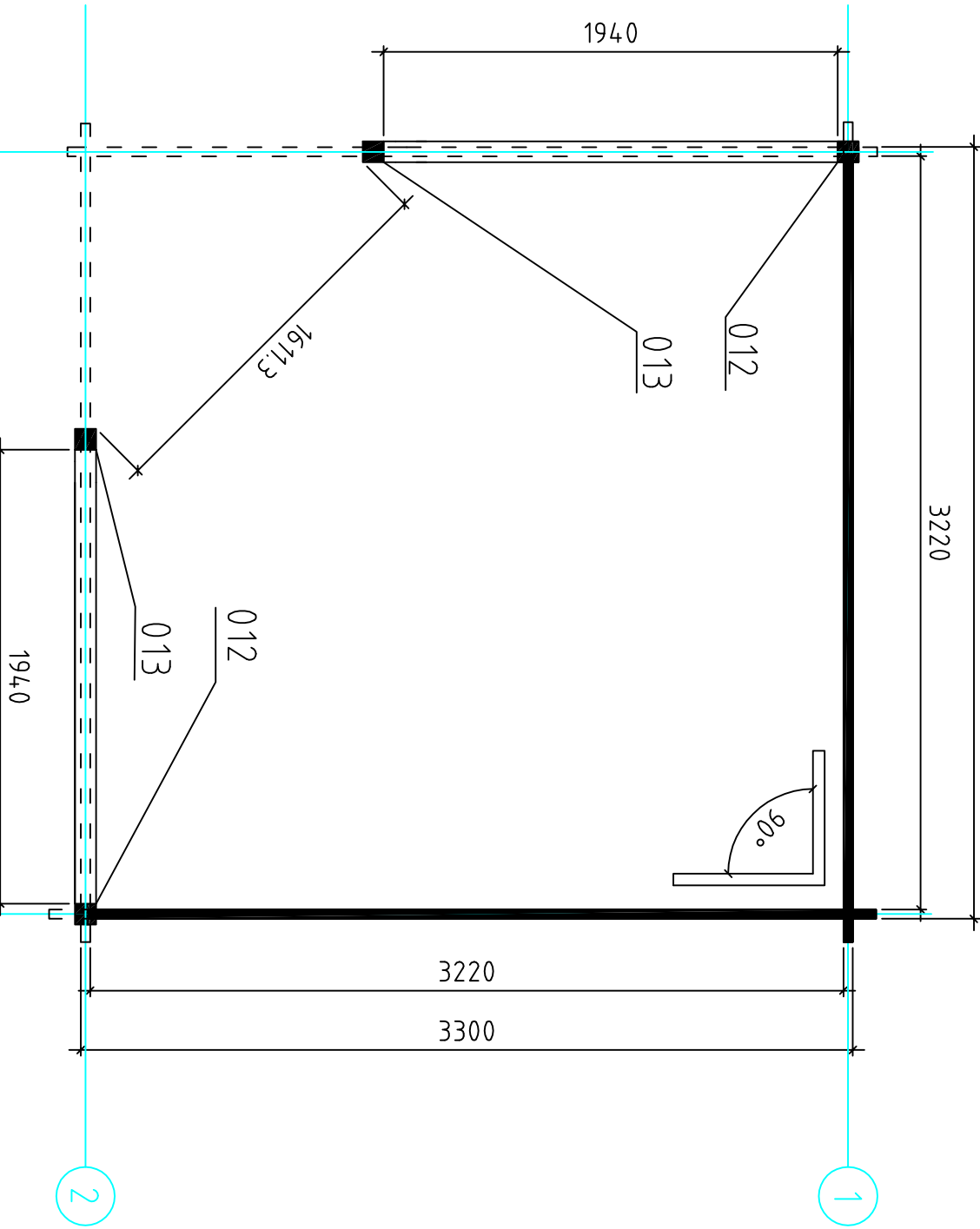

A

B

Grundplan

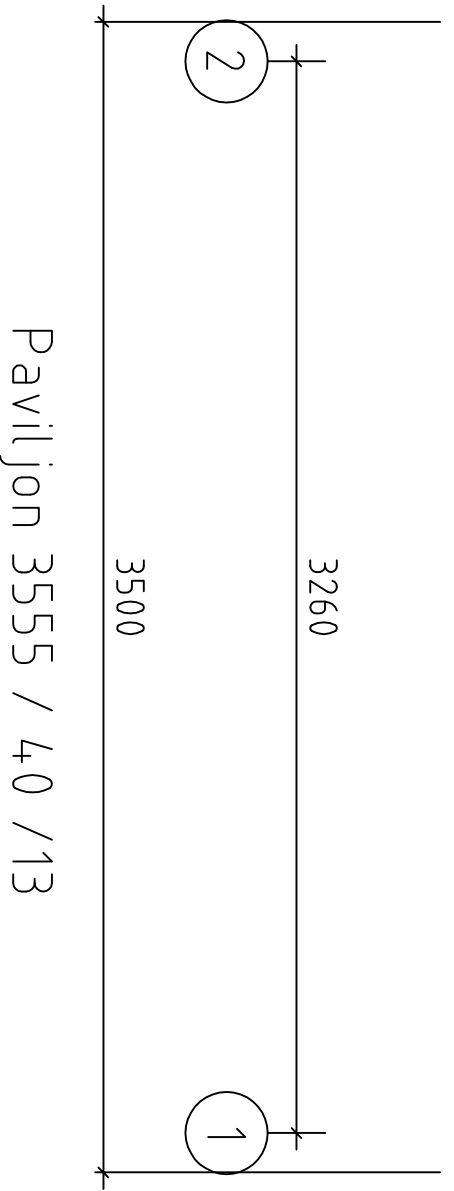
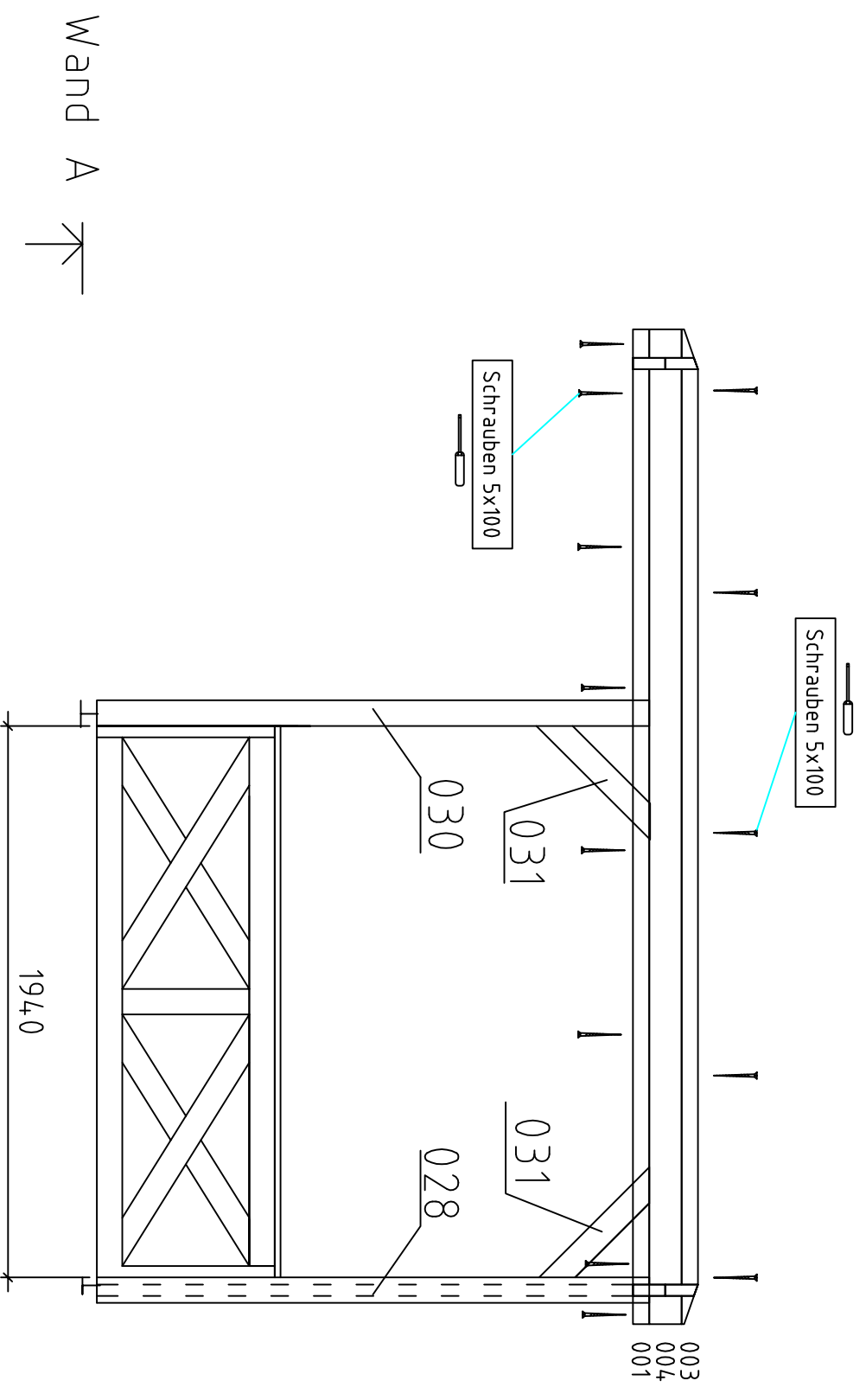

Paviljon 3555 / 40 / 13

Schrauben 5x100

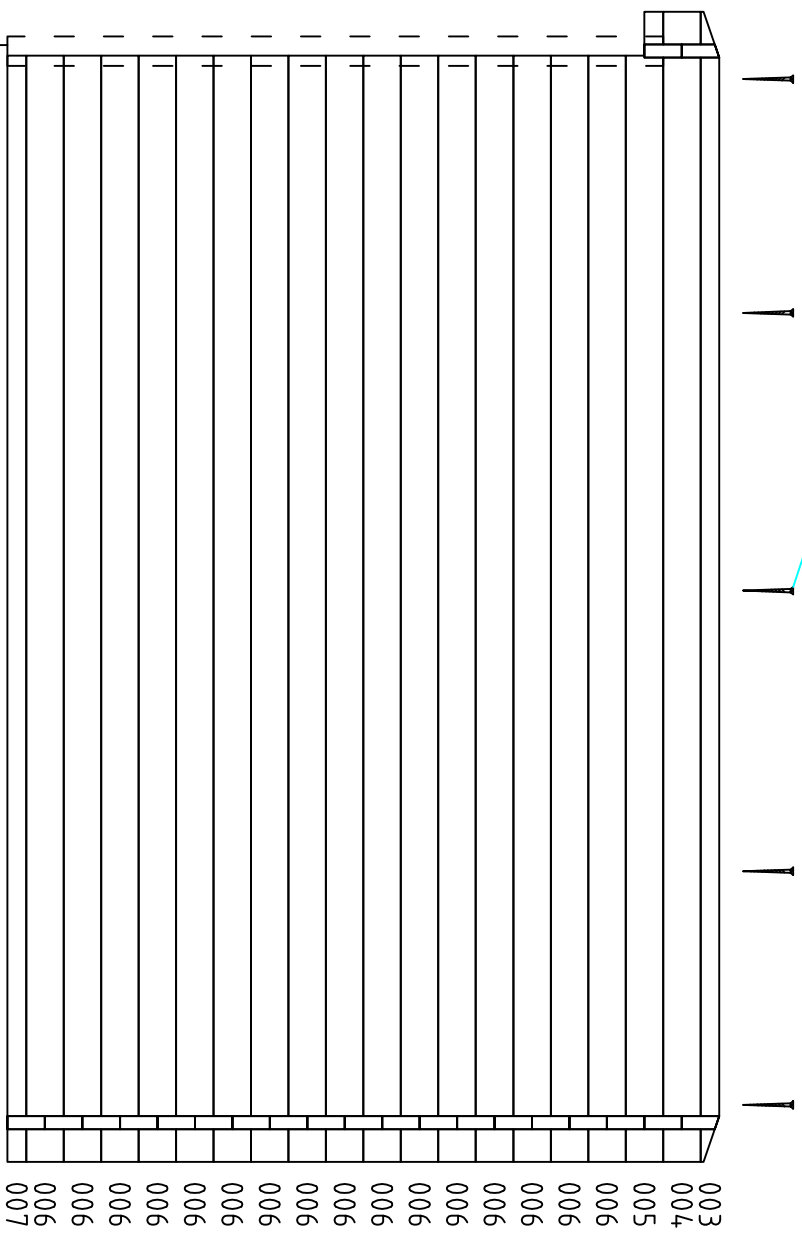

Wand B

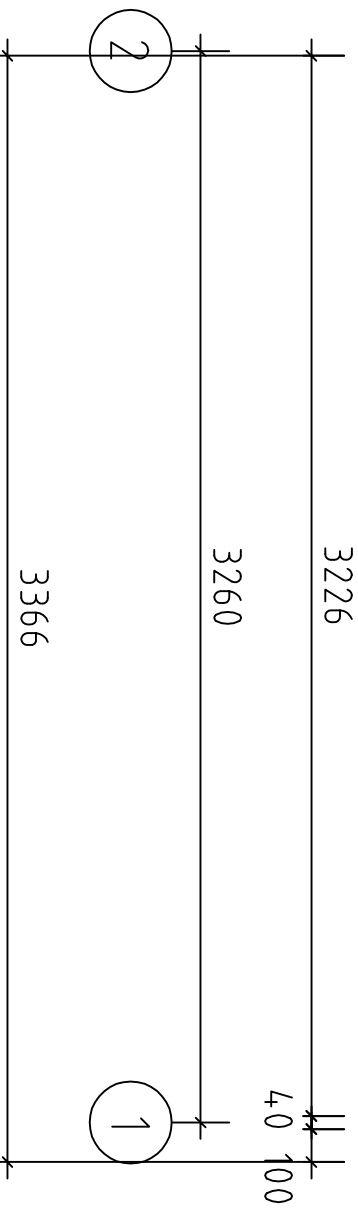

Paviljon 3555 / 40 / 13

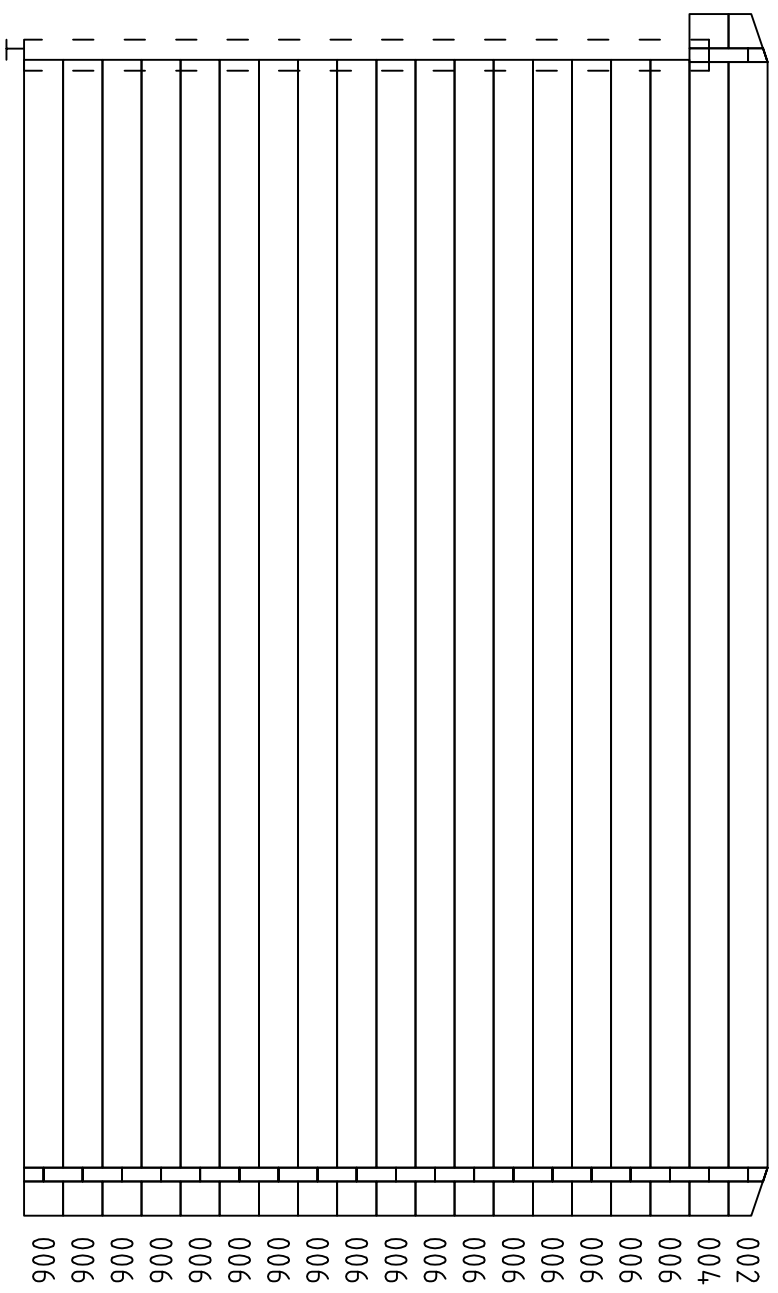

Wand 1 ↗

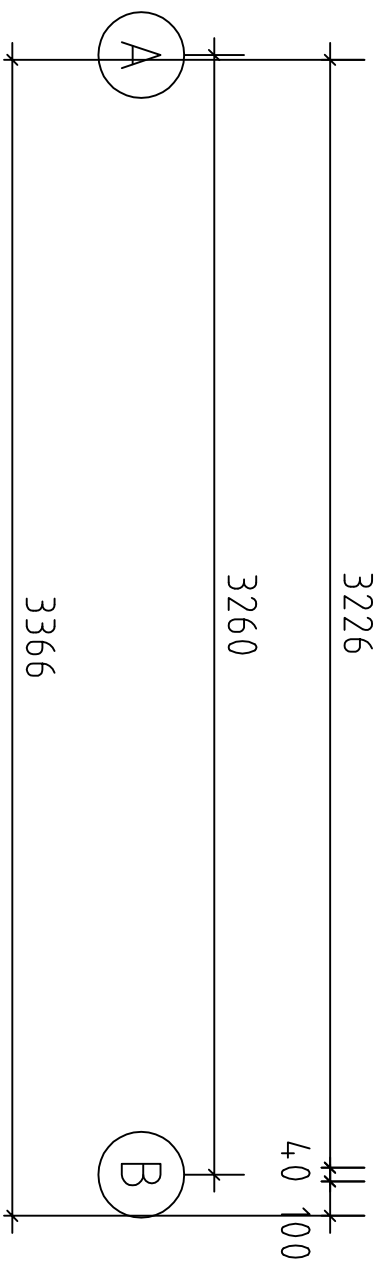

Paviljon 3555 / 40 / 13

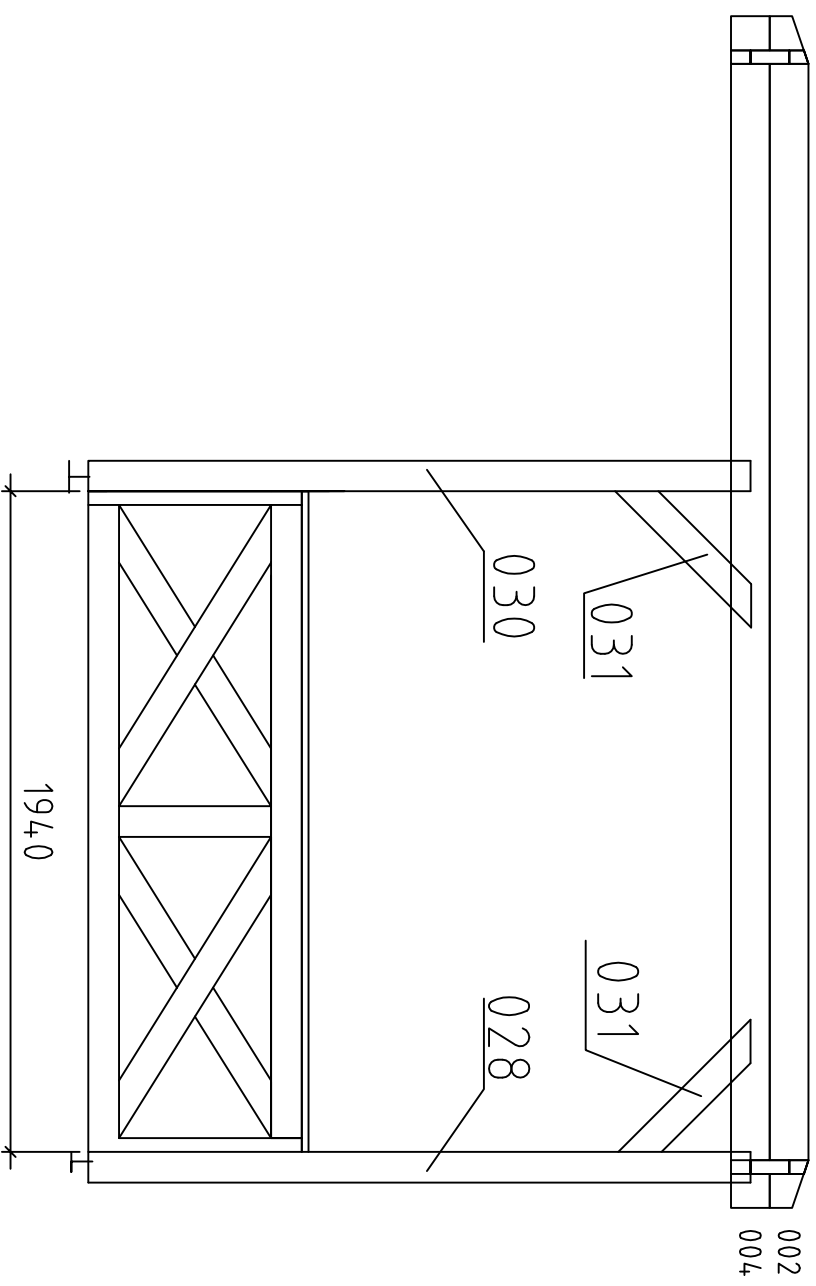

Wand 2 ↗

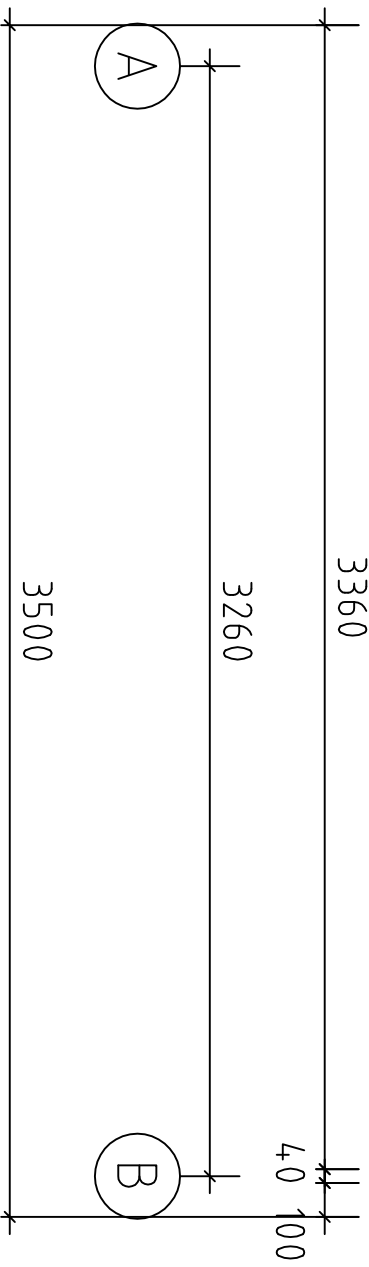

Paviljon 3555 / 40 / 13

Wand 2

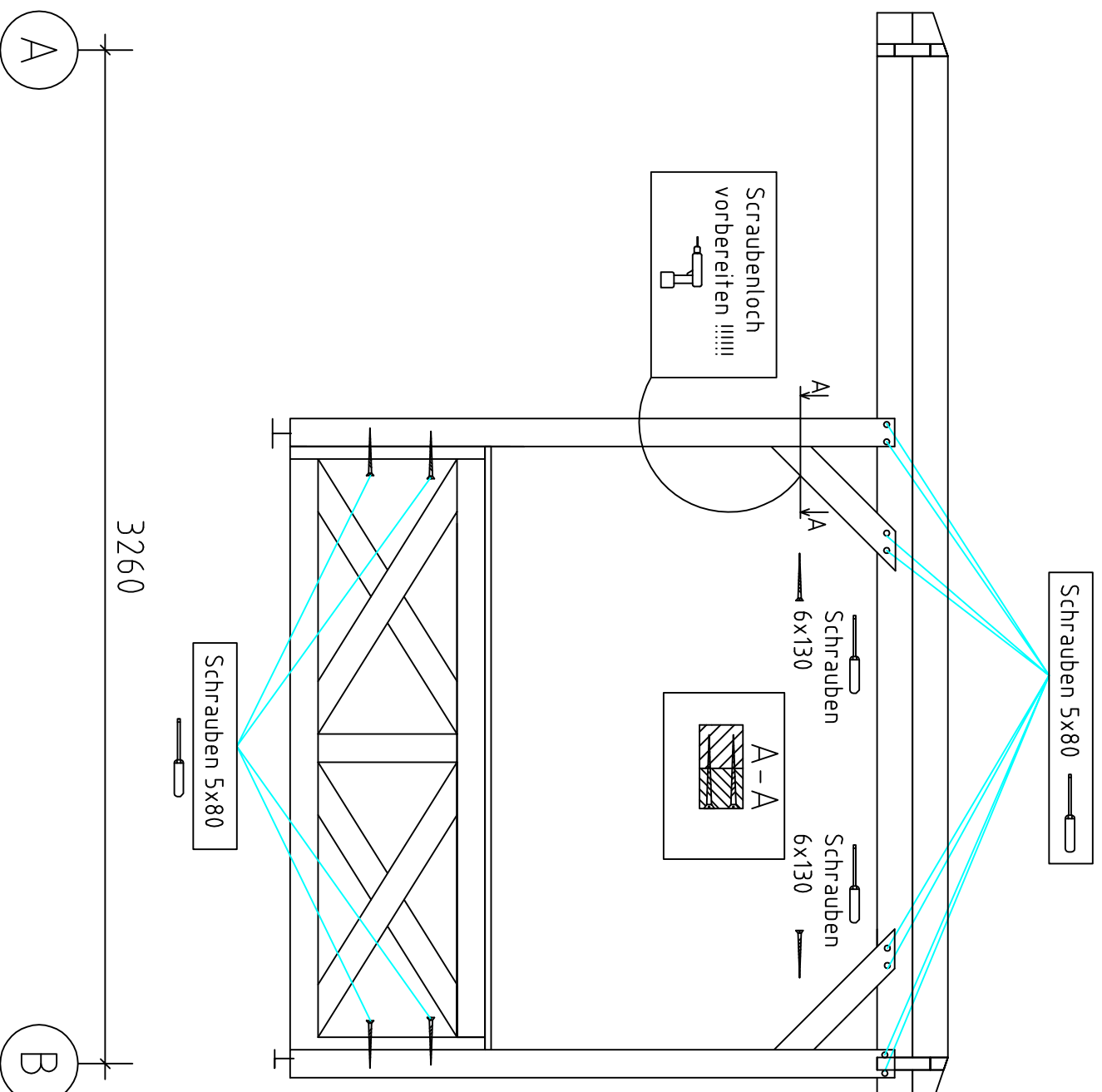

Paviljon 3555 / 40 / 13

Wand A

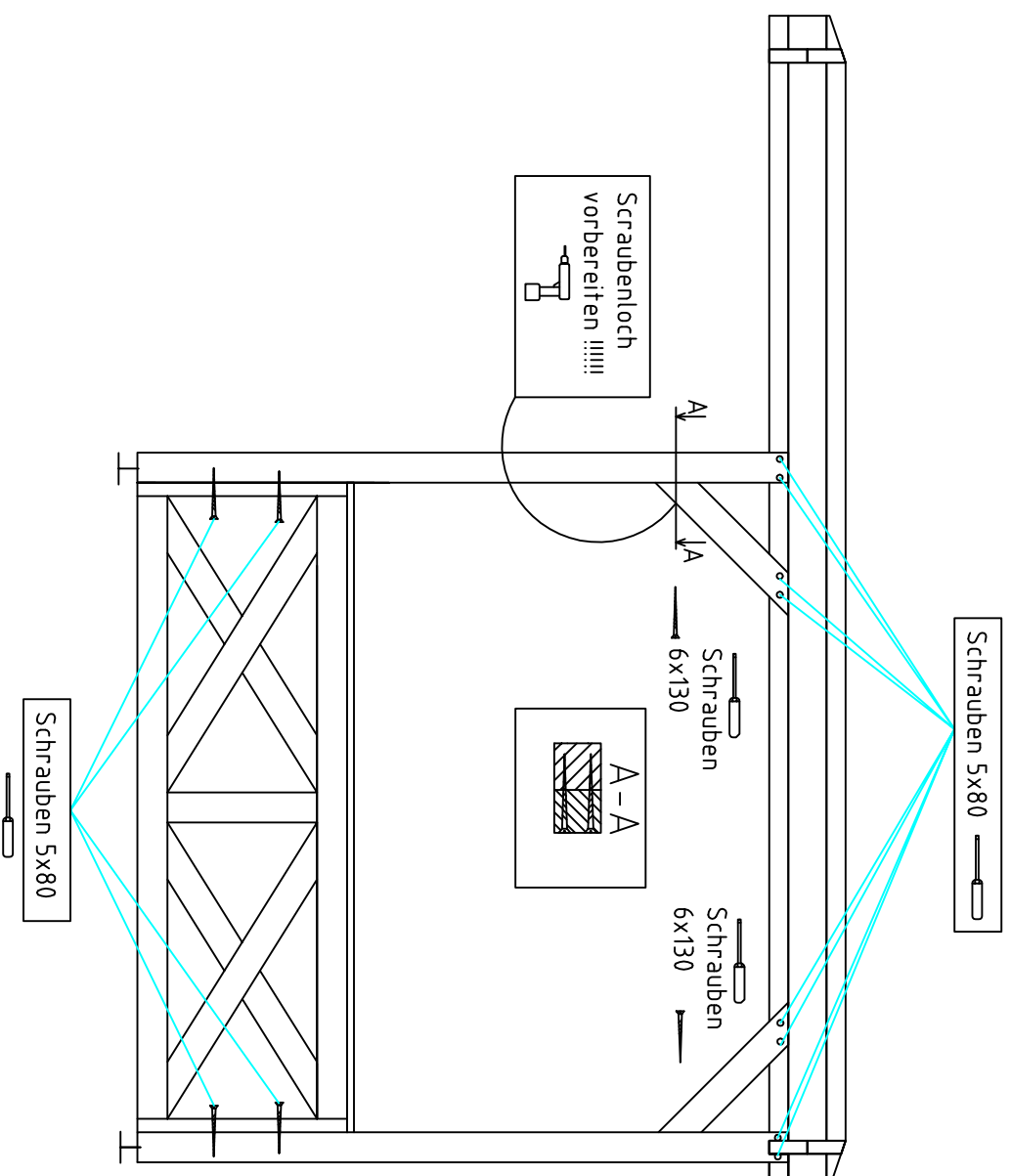

3260

2

1

Paviljon 3555 / 40 / 13



Paviljon 3555 / 4,0 / 13

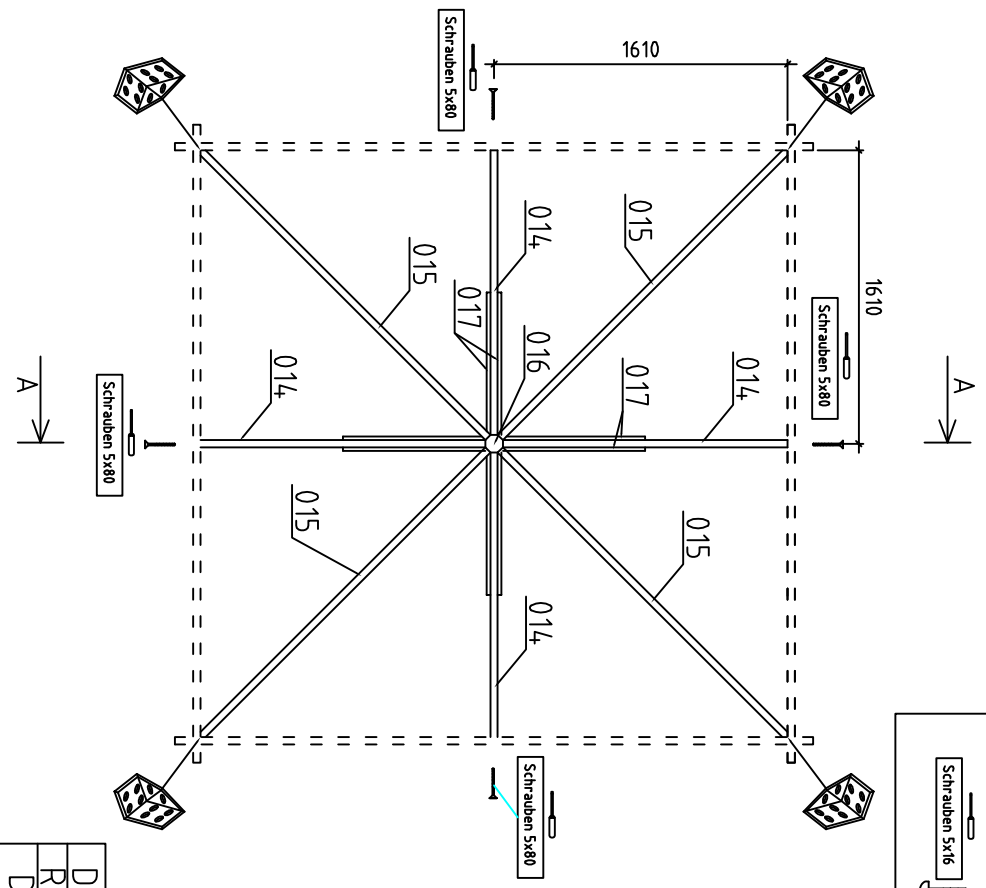

- Dachbalken
- Roofbeam
- Dakbalken

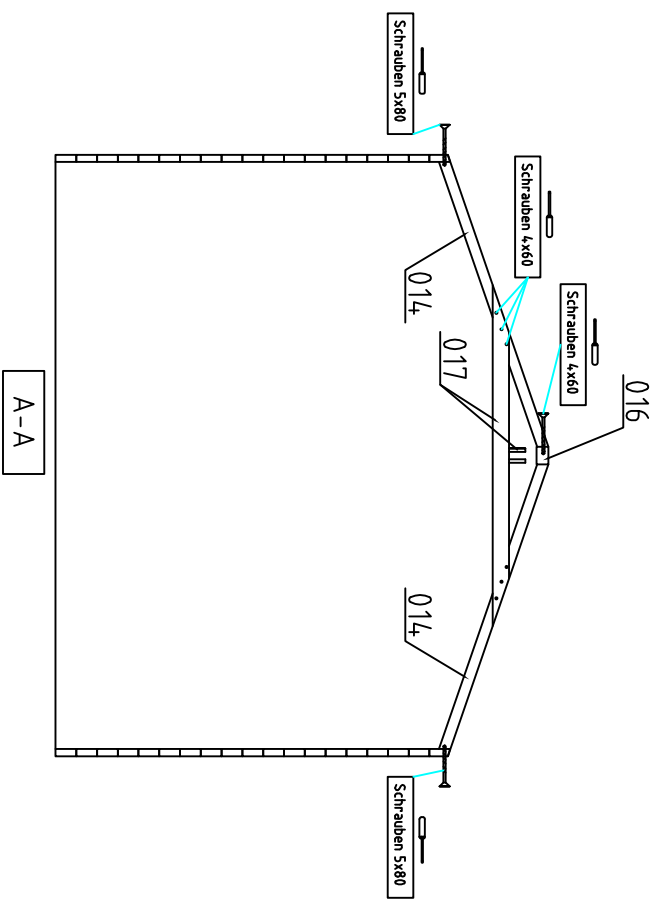
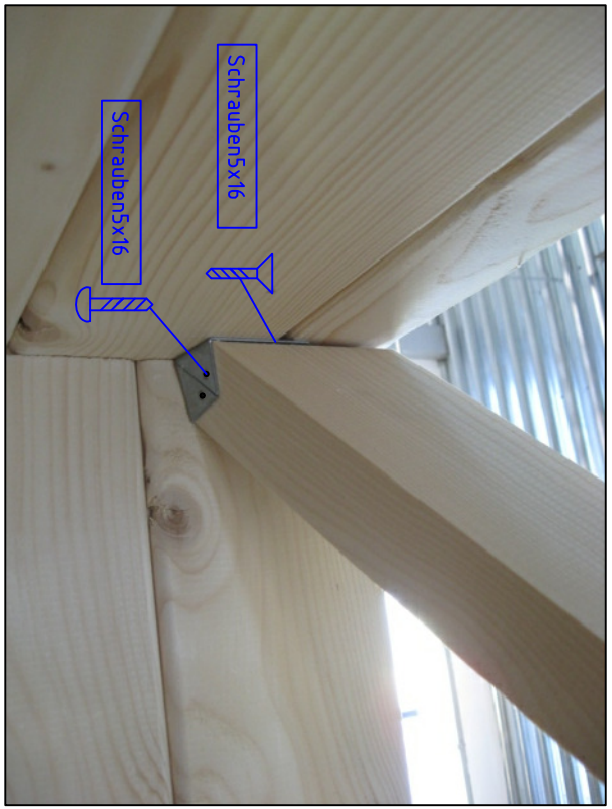
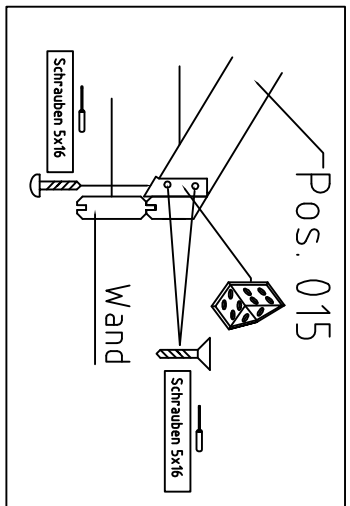

Paviljon 3555 / 40 / 13

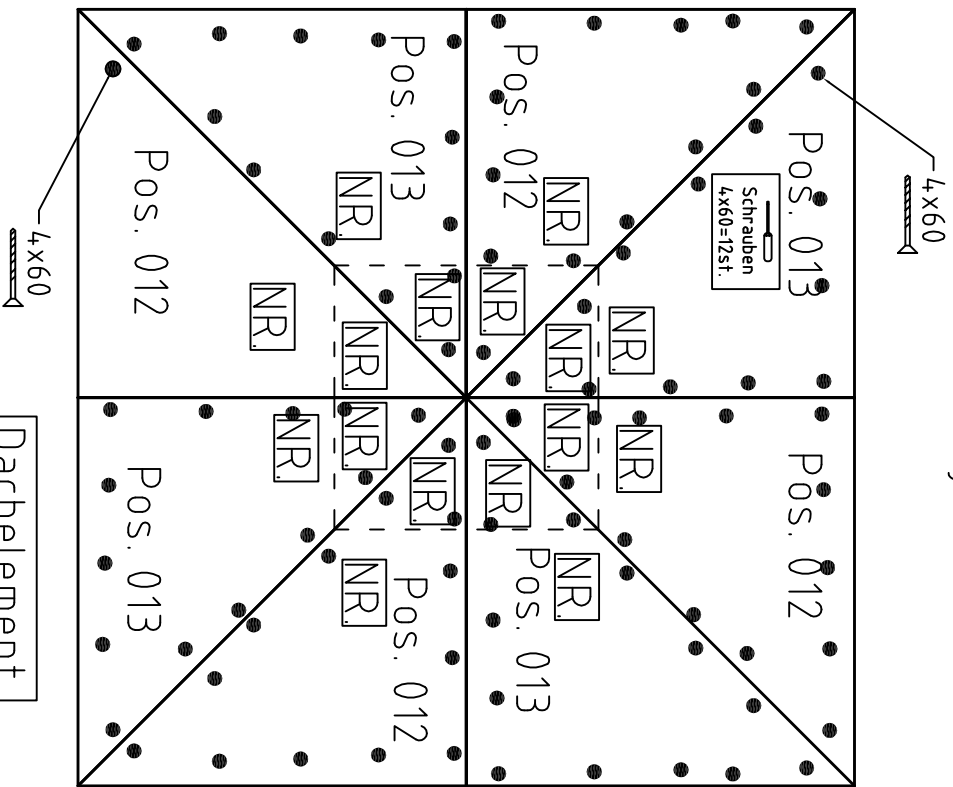

Dachelement
Roofelement
Dakelement

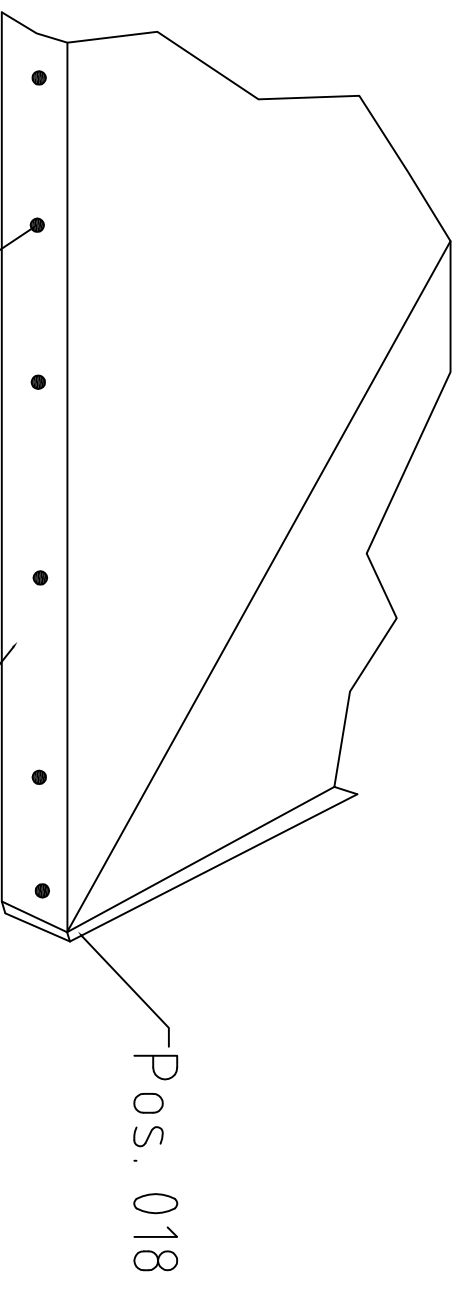

Leiste
List
Lijsten

Pos	Paviljon 3555 / 40 /13						ST	F (mm)	L (mm)
001							1	40x57	3500
002							2	40x114	3500
003							2	40x57	3500
004							4	40x114	3500
005							1	40x114	3500
006							33	40x114	3366
007							1	40x57	3366
008							2		1940
009	Pfosten						2	90x90	1945
010	Pfosten						2	90x90	1945
011	Träger						4	90x90	560
012	Dachelement Roofelement Dakelement						4	1945x1851	
013	Dachelement Roofelement Dakelement						4	1945x1851	
014	Dachbalken Roofbeam Dakbalken						4	40x58	1671
015	Dachbalken Roofbeam Dakbalken						4	40x58	2303
016	Firstelement Ridge-element Nokstuk						1	97x97	120
017	Zange für Dach						4	20x90	1870
018	Leiste List Lijsten						4	20x70	4000
		3x40	5x80	5x100	5x16	5x16		4x60	6x130
Beslag Beschlag Metalworks									
	40 st.	30st.	20 st.	16 st.	8 st.	4 st.	140 st.	8 st.	