

P 3051/28

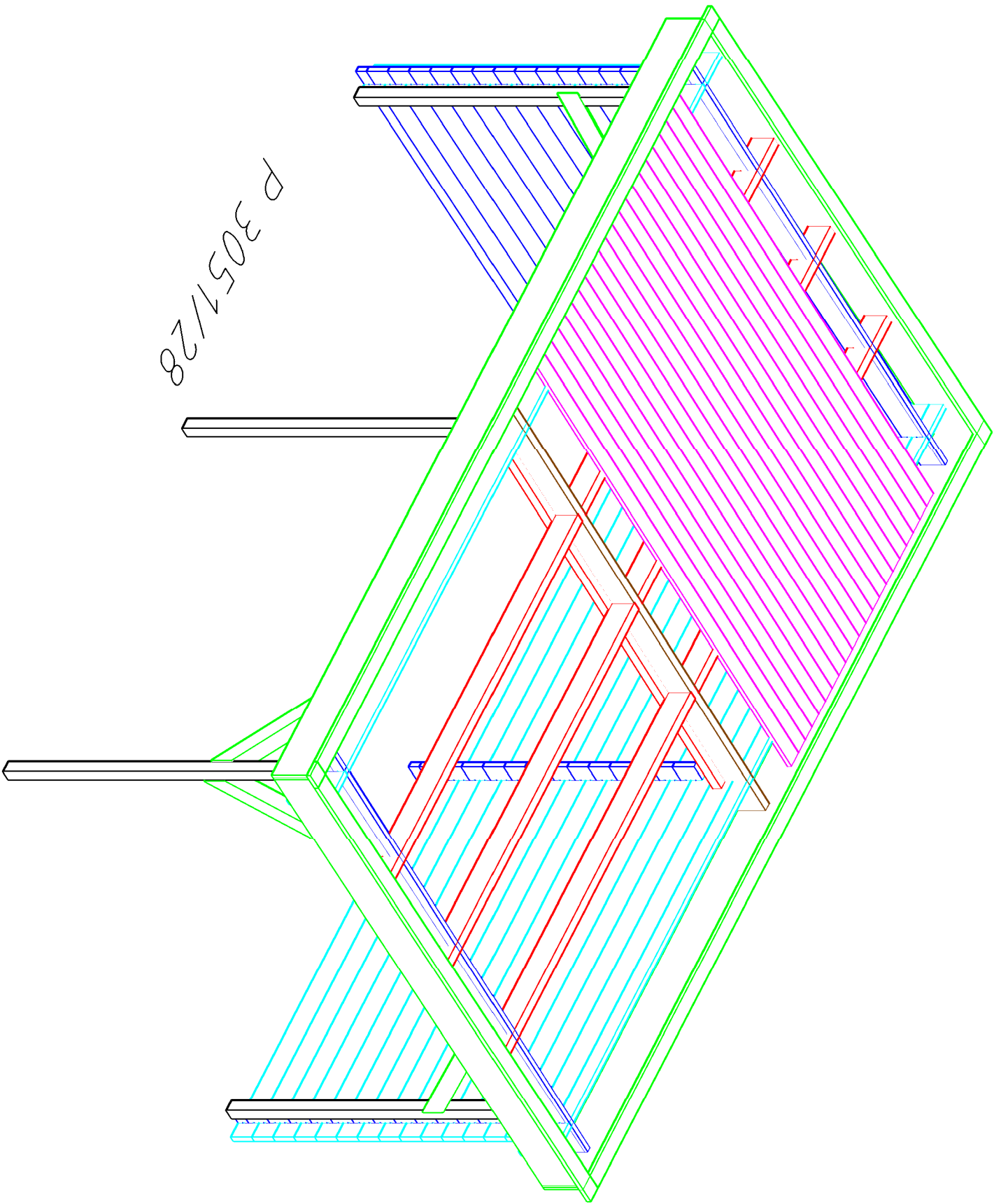

PaV. 3051 / 28

5200

2976

2720

5000

A

C

B

2

1

Grundplan

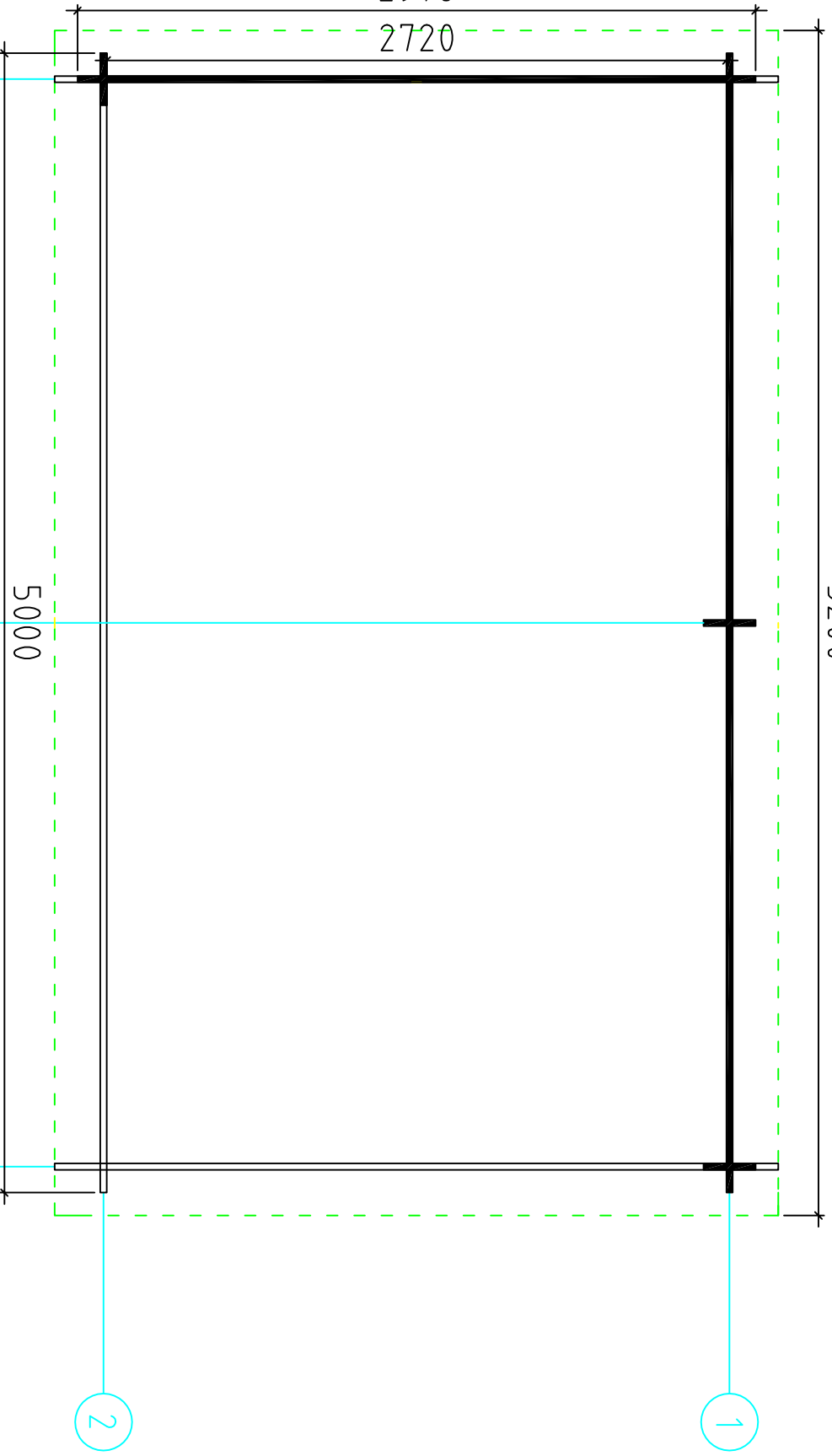

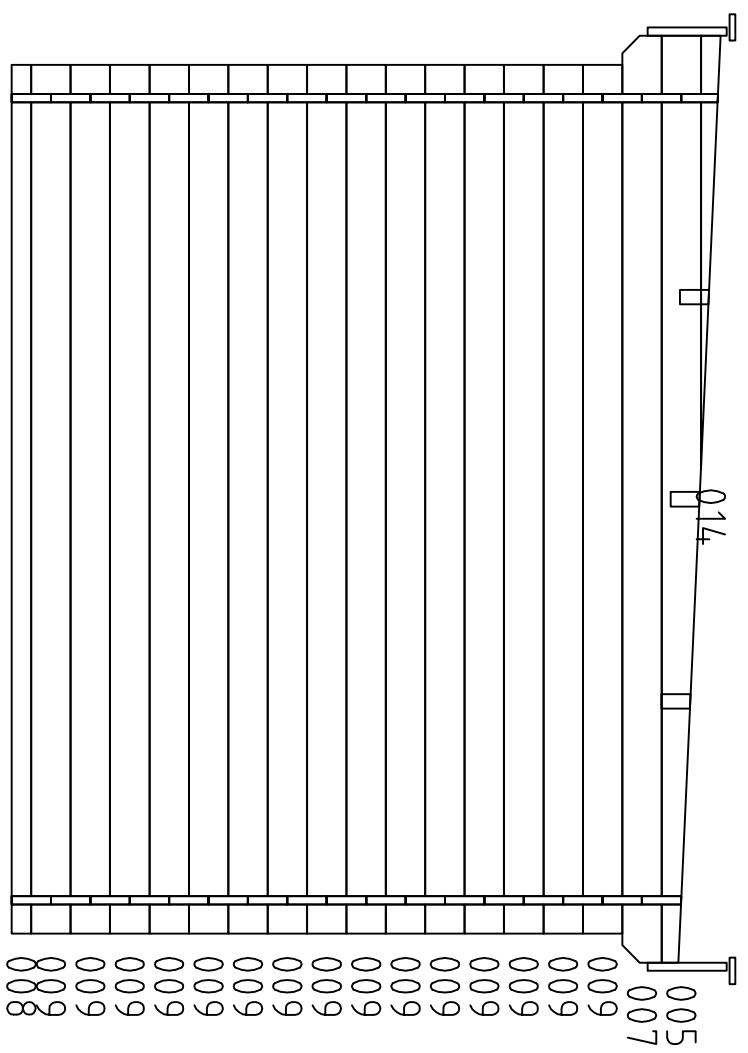

Wand A ↗

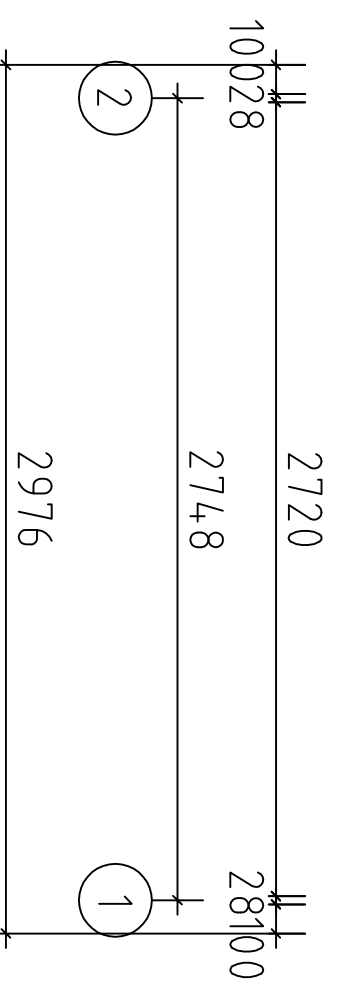

PAV. 3051 / 28

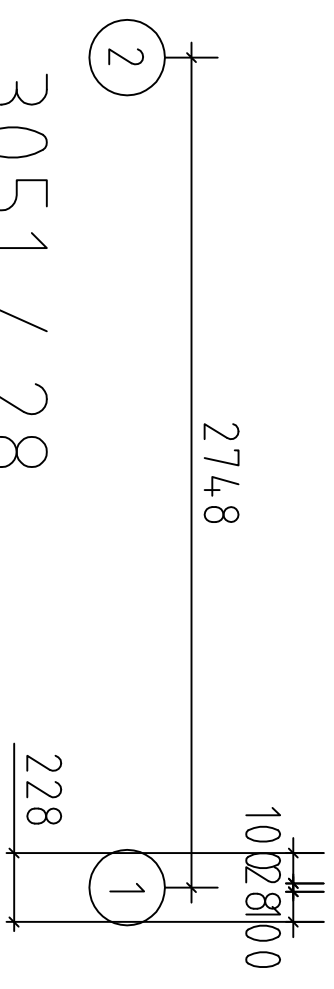
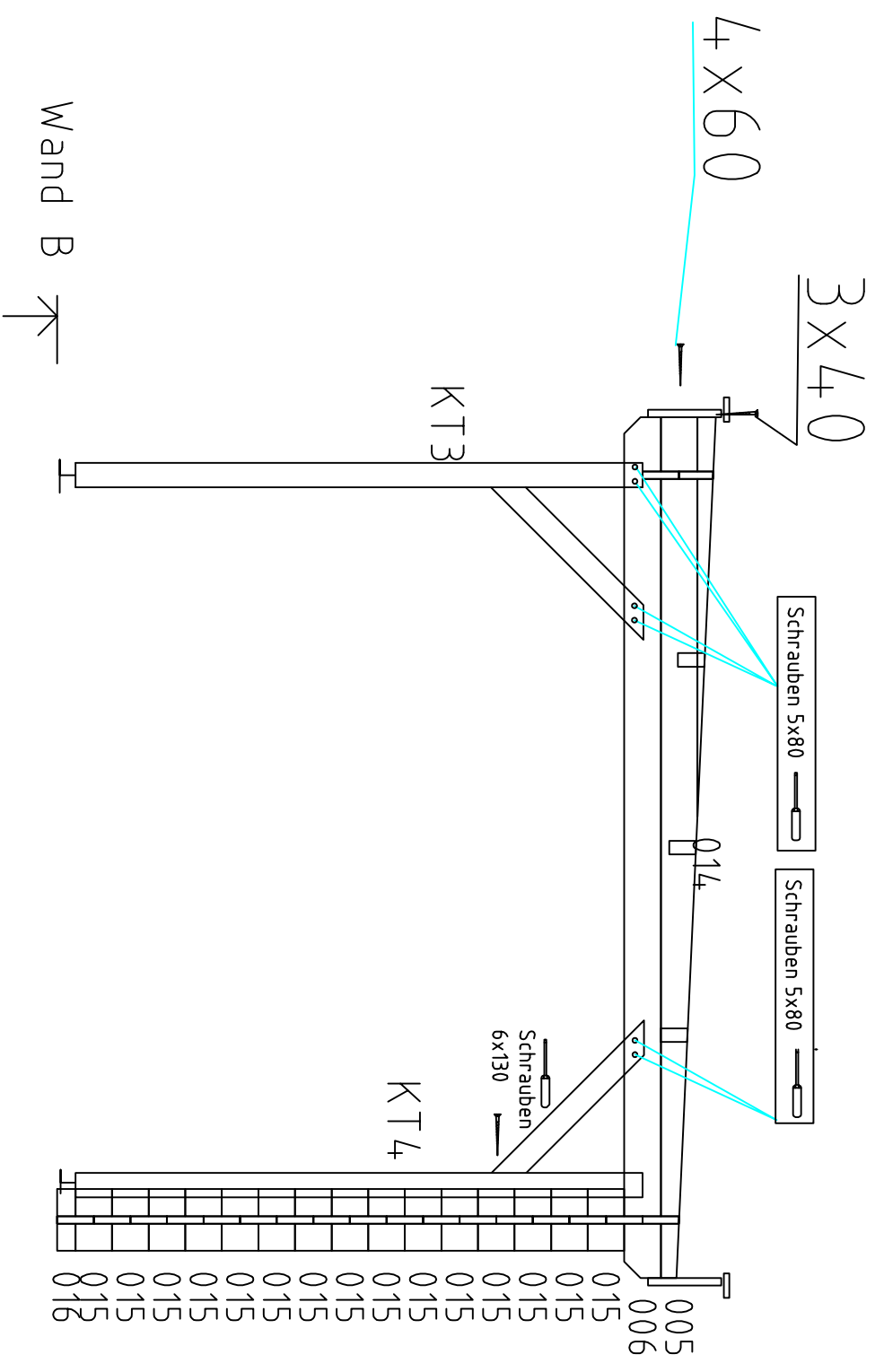

Pav. 3051 / 28

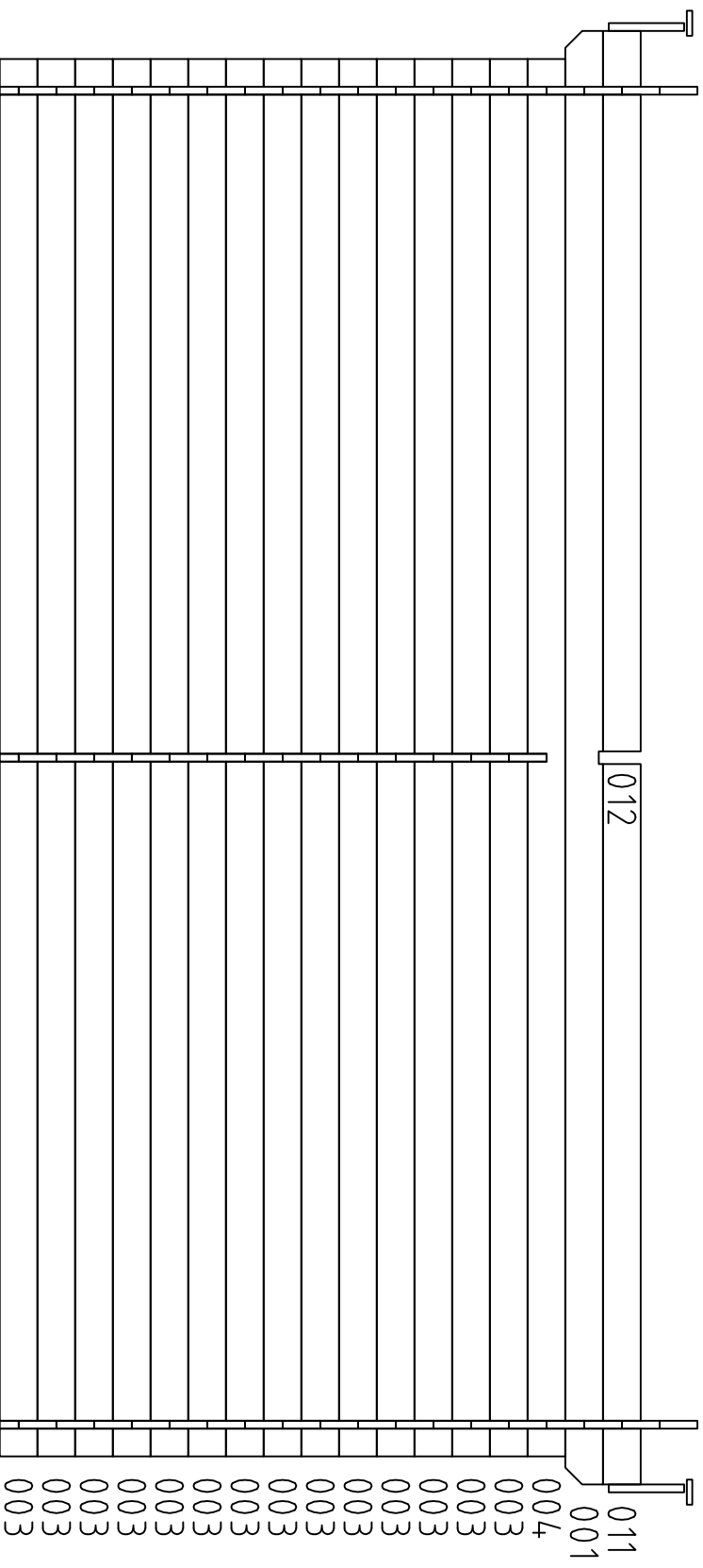

Wand 1 ↗

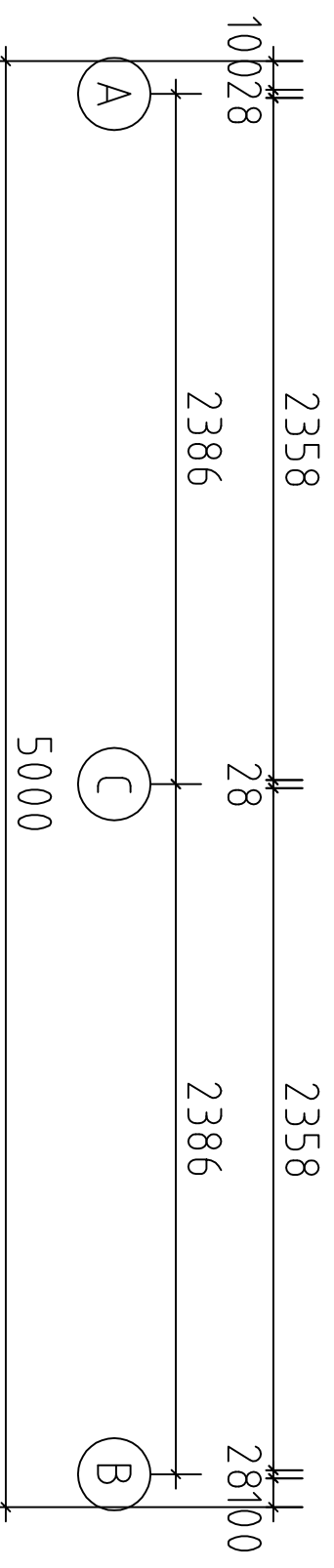





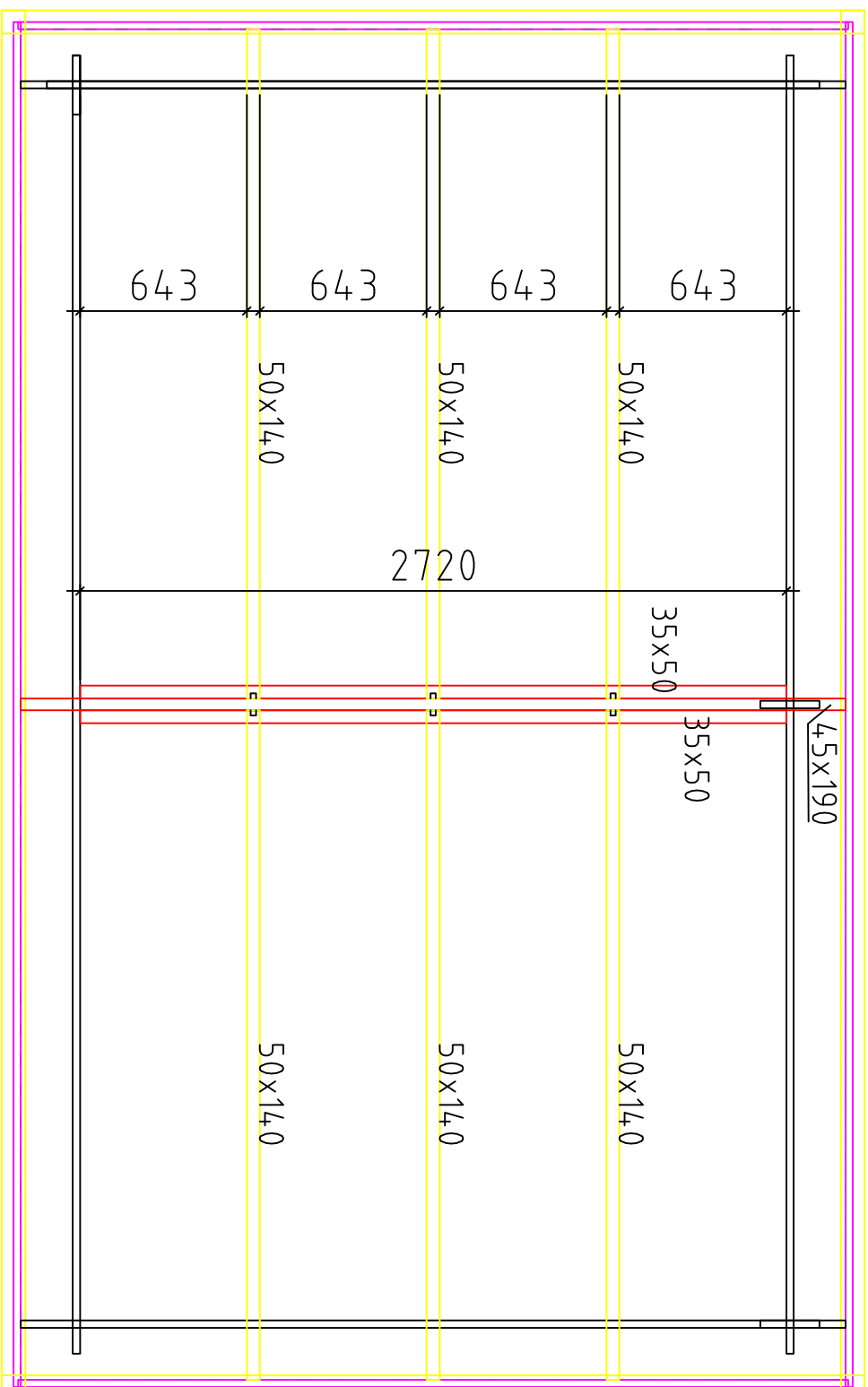

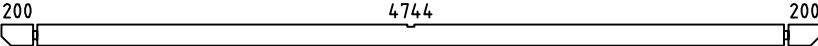
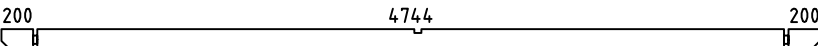
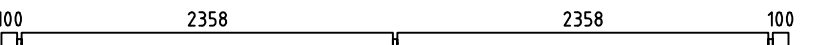
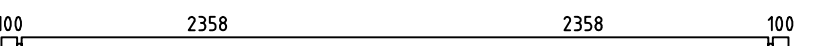
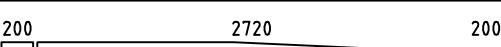
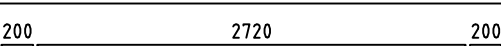
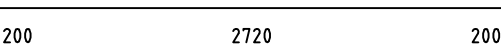
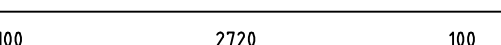
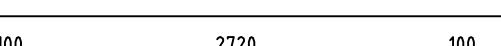
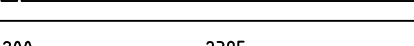
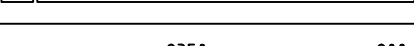
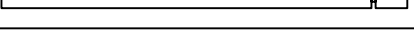
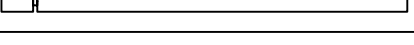
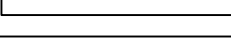

Pav. 3051 / 28

PAV. 3051 / 28

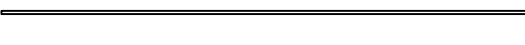

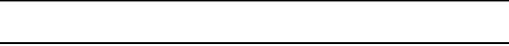
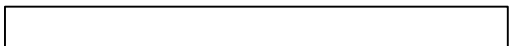
Dachbalken

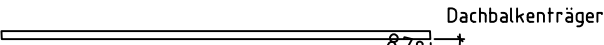
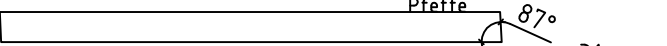
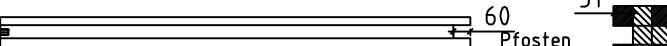
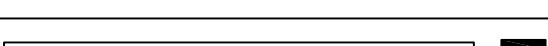
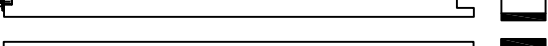
Pos	Pav. 3051 / 28	ST	F (mm)	L (mm)
001		1	28x135	5200
002		1	28x135	5200
003		14	28x135	5000
004		1	28x135	5000
005		2	28x135	3176
006		1	28x135	3176
007		1	28x135	3176
008		1	28x68	2976
009		15	28x135	2976
010		1	28x126	2578
011		1	28x135	2578
012		1	28x135	2578
013		1	28x126	2578
014		2	28x68	1474
015		45	28x135	228
016		2	28x68	228
HL2		4	90x20	2800
HL1		2	90x20	3500
vÖ2		2	28x270	5256
vÖ1		2	28x270	3196
SA3		4	90x90	600
SA1		2	50x50	2725
SA2		1	45x190	3188
KT1		1	90x90	2160
KT4		1		2090
KT2		1		2160
KT3		1		2090

