

S8207

NL

Bedankt voor de aanschaf van dit product.

Bij eventuele schade of problemen, vragen wij u onze website www.solid.eu/sav te raadplegen en de procedure te volgen die op onze website uitgelegd wordt. Als u niet in de mogelijkheid bent om via het web de aanvraag te doen, vragen wij u te bevestigen naar de winkel waar u uw constructie heeft gekocht, samen met de beschadigde stukken (of met een foto) en met de **Stuklijst**, terug te vinden in het montageplan, zodat een eerste controle door de winkel uitgevoerd kan worden. Vergeet ook niet de barcode (beginnend met ASKAO) mee te nemen of ze te vermelden op de **Stuklijst** op de voorziene plaats. U kan deze terug vinden op het etiket op de verpakking van de constructie ofwel op de leveringsbon. (zie uitleg hieronder)
Al deze zaken zijn onontbeerlijk en dus noodzakelijk voor de behandeling van uw klacht.

F

Nous tenons à vous remercier pour l'acquisition de ce produit.

En cas de problèmes ou de dégâts, nous vous invitons à vous rendre sur le lien internet suivant www.solid.eu/sav et à suivre la procédure indiquée sur la page web. S'il ne vous est pas possible de vous rendre sur internet, il vous est demandé de prendre contact avec le magasin où vous avez acheté votre produit, muni des pièces défectueuses (ou d'une photo) et la **Liste des pièces** figurant dans le plan de montage, afin qu'un premier contrôle puisse être effectué par le magasin. Veuillez transmettre le code barres (commençant par ASKAO), ou le mentionner dans la **Liste des pièces** à l'endroit indiqué. Vous le trouverez sur l'étiquette de l'emballage de votre produit ou sur le bon de livraison (voir explication ci-dessous). Ces données sont indispensables au traitement de votre réclamation.

GB

Thank you for acquiring this product.

In case of problems or damages please visit our website www.solid.eu/sav and follow the instructions. If not possible to access our webpage by internet please contact the shop where the product was bought, provided with the flawed parts (or with a picture) and the **Bill of material** enclosed in the assembly plan, so that the shop can carry out a first control. Also communicate the following bar code (beginning with ASKAO) or mention it in the **Bill of material** in the field provided. You can locate the bar code on the label fixed on the packaging or on the delivery order. (explained below) information is needed in order to handle your claim.

D

Vielen Dank für den Kauf dieses Produkt.

Bitte wenden Sie sich bei eventuellen Beschädigungen oder Problemen an unsere website www.solid.eu/sav und folgen sie unseren Website. Wenn Sie nicht in der möglichkeit die Anforderung über das internet zu machen, bitte wenden Sie sich an den Händler, bei dem Sie Ihr Produkt gekauft haben, und nehmen Sie die beschädigten Teile (oder ein Foto davon) sowie der **Materialliste**, das Sie im Montageplan finden, mit, sodass ihr Händler das Problem untersuchen kann. Bitte denken Sie auch an unten stehenden Barcode (beginnend mit ASKAO). Nehmen Sie diesen ebenfalls mit oder geben Sie ihn an der dafür vorgesehenen Stelle auf dem **Materialliste** an. Sie können diese zurück finden auf das Etiket von der Verpackung der Konstruktion oder auf der Lieferschein (siehe Erklärung unten) Oben genannte Informationen und Dokumente sind für die Bearbeitung Ihrer Beschwerde notwendig.



- NL Verpakking
- F Emballage
- GB Packaging
- D Verpackung



- NL Sticker
- F Autocollant
- GB Sticker
- D Aufkleber

Kopie pakbon **Ma 14-20209**

SOLID
creating outdoor comfort

SOLID B.V.A.
Industrieweg 8
6801 SP Breda
www.solid.eu

RSUB: 2106
RF: 026, TRIB: HAREZHE
RUB: 0604, RUC: 11,1
1140: 14, 158L (RUB: 0,3)

Leveringsdatum: 14-11-2019
Leveringsadres: 14-11-2019
Aankoopadres: 14-11-2019
Overval: 14-11-2019
Bevestigingsdatum: 14-11-2019

Alert: 14-11-2019
Invoeren: 14-11-2019
Leveringsmethode: 14-11-2019
Overname: 14-11-2019
Sluiterperiode: 14-11-2019

Artikelnummer	Ref klant	Omschrijving	Lengte	Kleur	Kwaliteit
S8207	026017	14-11-2019 14-11-2019 (2019-11-14)			

Serie ID: 14-11-2019

Aantal coli: 1
Aantal pallets: 1
Totaal gewicht: 0,00 KG

Handtekening: _____

Indien gewenst verzorgen wij de montage van uw product aan heel interessante prijzen.
Contacteer ons op montage@solid.eu of 05696 1679

Contacteer ons:
www.solid.eu
op onze website vindt u alle informatie over uw product, montageplan, montageplannen en veelgestelde vragen

montage@solid.eu
wilt u een probleem met het product (ontbrekende, verkeerde, defecte, ... onderdelen), gelieve het online formulier in te vullen

montage@solid.eu
wilt u een montageplan in te schakelen voor het plaatsen van uw product, gelieve ons per mail te contacteren

Solid Breda neemt uw privacy serieus. De persoonsgegevens die wij van u zouden hebben worden niet ook behandeld conform de wetten van de GDPR. (meer info: <https://www.solid.eu/privacy>)
Door samen te werken met Solid Breda gaat u uitdrukkelijk akkoord en aanvaardt u onze algemene verkoopvoorwaarden. Deze vindt u terug op www.solid.eu/voorwaarden

Totaal volume: 1

DE CLAUSULE VAN EIGENDOMSVOORBEHOUD IS VAN TOEPASSING BIJ DEZE LEVERING IN GOEDE STAAT ONTVANGEN.

Productie: 14-11-2019
Productie: 14-11-2019
Productie: 14-11-2019
Productie: 14-11-2019

- NL Leveringsbon
- F Bon de livraison
- GB Delivery note
- D Lieferbeleg



ASKAOXXXXXXXXXX

- NL Dienst na verkoop
- F Service Après Vente
- GB After Sales Service
- D Kundendienst

Stuklijst / Liste des pièces / Bill of material / Materialiste

S8207

Ref.	Index	#
A	WV023804-14-11-2019-0-1580	2
B	WV023804-14-11-2019-0-1580	19
C	WV023804-14-11-2019-0-1580	7
D	WV023804-14-11-2019-0-1580	6
E	WV023804-14-11-2019-0-1580	24
F	WV023804-14-11-2019-0-1580	2
G	WV023804-14-11-2019-0-1580	13
I	WV023804-14-11-2019-0-1580	2
J	WV023804-14-11-2019-0-1580	48
K	WV023804-14-11-2019-0-1580	3
L	WV023804-14-11-2019-0-1580	7
M	WV023804-14-11-2019-0-1580	4
N	WV023804-14-11-2019-0-1580	2
O	S-011 Kaefling 3,5m	1
P	S8207-23	1

Gereedschap (excl.) / Outils (excl.) / Tools (excl.) / Werkzeuge (excl.)

S8207

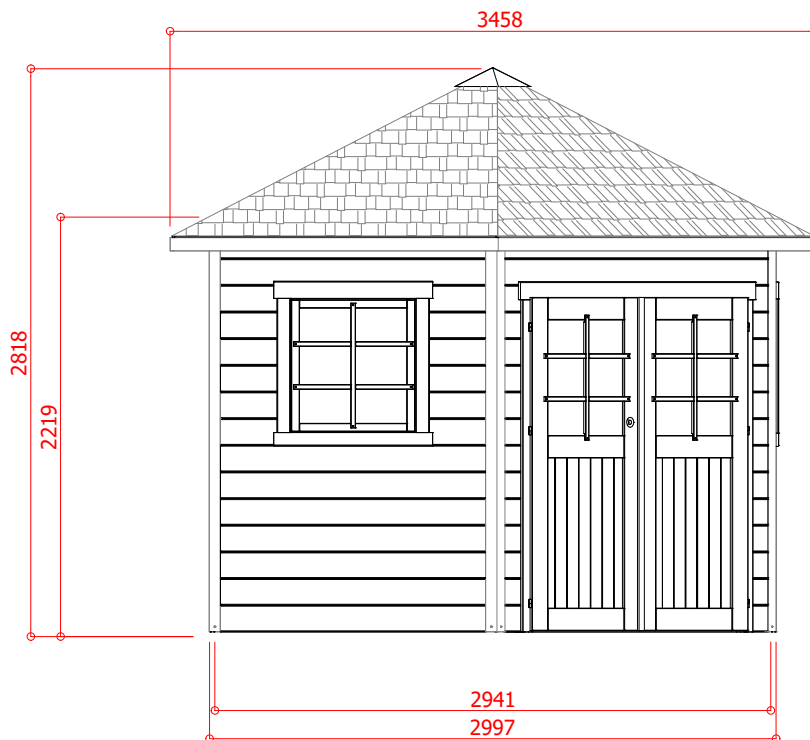
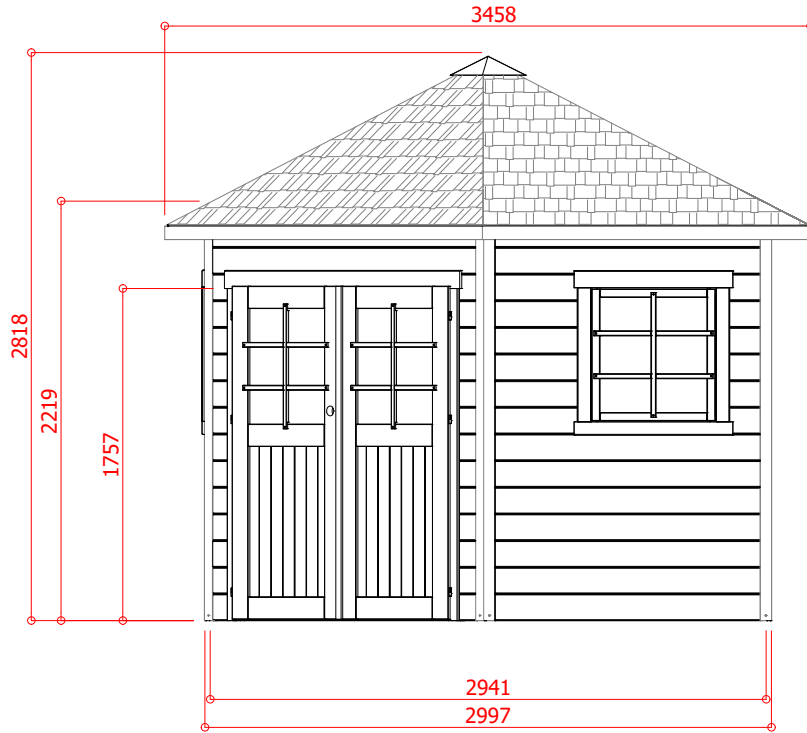

	7.78 m ²
	7.88 m ²

Schaal / Échelle / Scale / Escala / Escala / Scala : 1:40

Dakhelling ± 16 °	Pendente ± 16 °
Pente ± 16 °	Pendiente ± 16 °
Gradient ± 16 °	Pendenza ± 16 °

Industriepark 8
8587 Spiere-Helkijn

CreateDate: 18.03.2020
SaveDate: 10.03.2021
PlotDate: 10.03.2021

C:\Users\NNSPRON\Desktop\Dia loty\body Solid\S8207.jpg





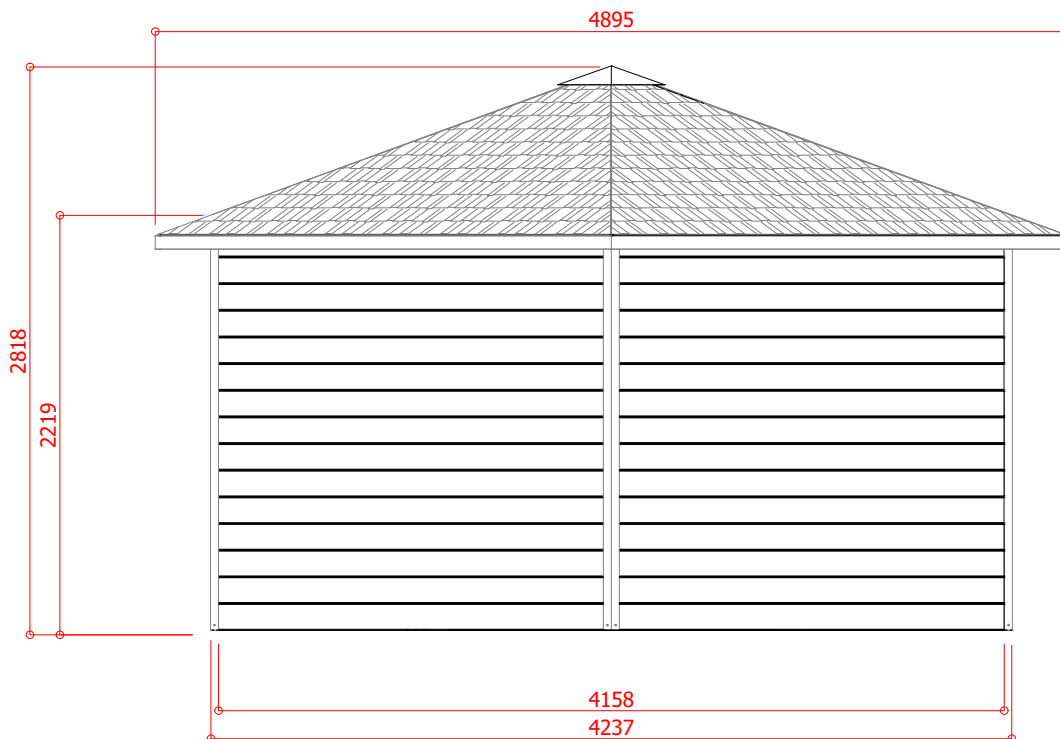
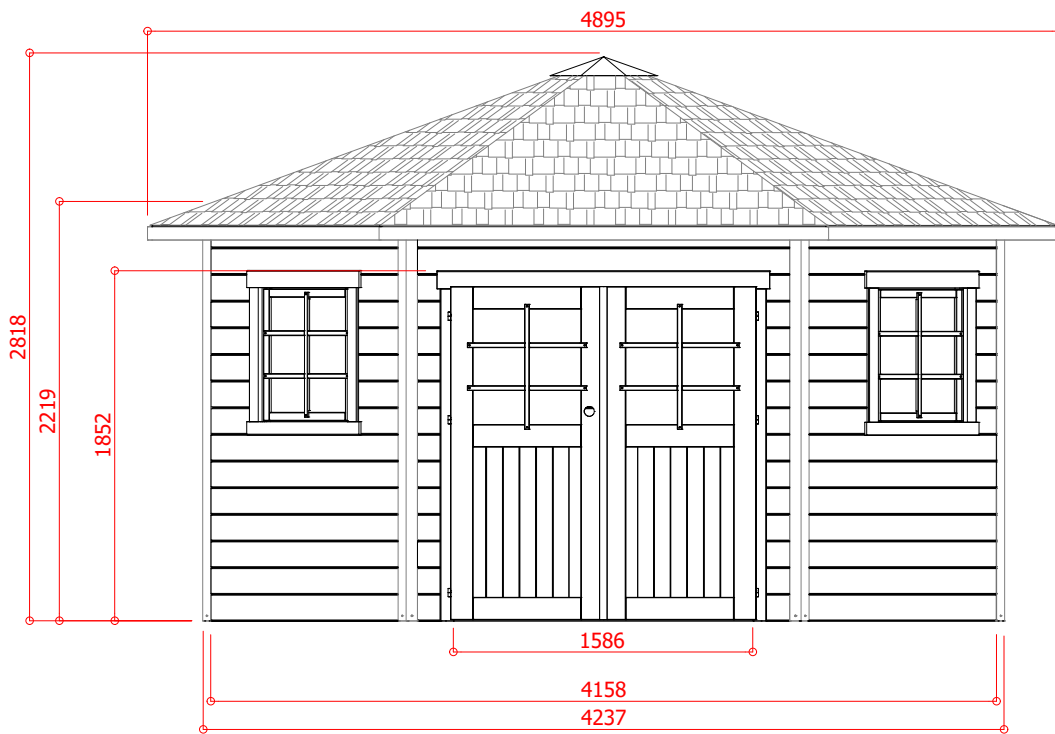





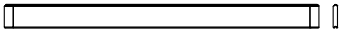
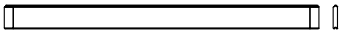
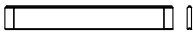
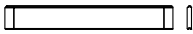
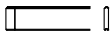
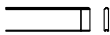
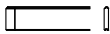
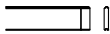
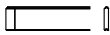
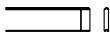
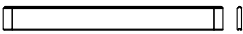
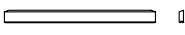

Deuropening / Embrasure de porte / Doorway / Apertura de puerta / Apertura delle porte / Abertura de portas	
Breedte / Largeur / Width / Anchura / Boca / Larghezza	1690
Hoogte / Hauteur / Height / Altura / Altezza / Altura	1899

S8207

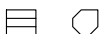

Industriepark 8
8587 Spiere-Helkijn

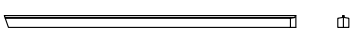
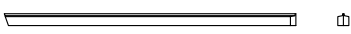
CreateDate: 18.03.2020
SaveDate: 10.03.2021
PlotDate: 10.03.2021

	Ref.	Bruto	L	Index	#
	A1	WW028x149	2960	15	
	A2	WW028x149	2980	15	
	A3	WW028x149	1504	9	
	A4	WW028x149	1514	9	
	A5	WW028x149	200	13	
	A6	WW028x149	200	13	
	A7	WW028x149	370	6	
	A8	WW028x149	380	6	
	A9	WW028x149	360	6	
	A10	WW028x149	380	6	
	A11	WW028x149	2065	2	
	A12	WW028x79	1432	2	
	A13	WW028x79	1432	2	
	A14	WW028x79	1450	1	
	A15	WW028x79	1450	1	
	A16	WW028x98	1993	1	
	H1	WW048x144	387	1	
	H2	WW048x144	387	1	
	H3	WW070x127	377	3	
	H	WW040x100	300	2	
	D1	WW0128x128	150	1	
	D2	WW056x60	2480	3	
	D3R	WW056x60	1835	1	
	D3L	WW056x60	1835	1	
	D4	WW056x50	1830	2	

S8207

PO _____

Winkel / Magasin / Store / :

Klant / Cliënt / Client / :

Verantwoordelijke / Responsable

Adres:



	Ref.	Bruto	L	Index	#
	F1	WW016x1857	3360	2	
	F2	WW016x1857	1695	1	
	F3	WW016x1857	1695	1	
	F4	WW016x1445	2325	1	
	M1	WW016x70	3400	2	
	M2	WW016x70	1800	2	
	M3	WW016x70	2500	1	
	P1	WW066x72	2085	1	
	P2	WW080x80	2085	2	
	P3	WW066x72	2085	2	
	D5	WW0400x400	90	1	

S8207











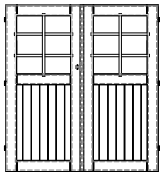
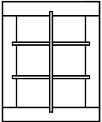
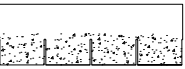

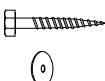
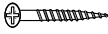

PO _____

Winkel / Magasin / Store / :

Klant / Cliënt / Client / :
Adres:

Verantwoordelijke / Responsable



	Ref.	Bruto	L	Index	#
        	P	<p>S8094C28</p> <p>+ 1 x S8094  + 1 x S8094-K28 </p> <p>+ 2 x S8092-T </p> <p>+ 1 x S8094-ALU </p> <p>+ 1 x S618 </p> <p>+ 2 x S5242 (glass 638 mm x 630 mm)</p> <p>+ 1 x S80201  + 6 x S6201 </p> <p>+ 1 x S673 </p>		1	
	Q	<p>S8102-28</p> <p>GLASS S5243 (595 x 638)</p>		2	
		<p>S577</p> <p>S6741</p> <p>M6x40 (20)</p> <p>M6 (20)</p> <p>3 x 30 (12)</p> <p>3 x 40 (30)</p> <p>3 x 70 (16)</p> <p>3,5 x 35 (37)</p> <p>4 x 50 (30)</p> <p>4 x 70 (2)</p> <p>5 x 70 (14)</p> <p>5 x 90 (7)</p> <p>4 (2)</p> <p>2.5 x 40 (260)</p> <p>2.5 x 16 (360)</p>		7	2

S8207

PO _____

Winkel / Magasin / Store / :

Klant / Cliënt / Client / :
Adres:

Verantwoordelijke / Responsable



- P1 = 1
 - P2 = 2
 - P3 = 2
 - A1 = 1
 - A2 = 1
 - A3 = 1
 - A4 = 1
 - A5 = 1
 - A6 = 1
- S8094-K #1

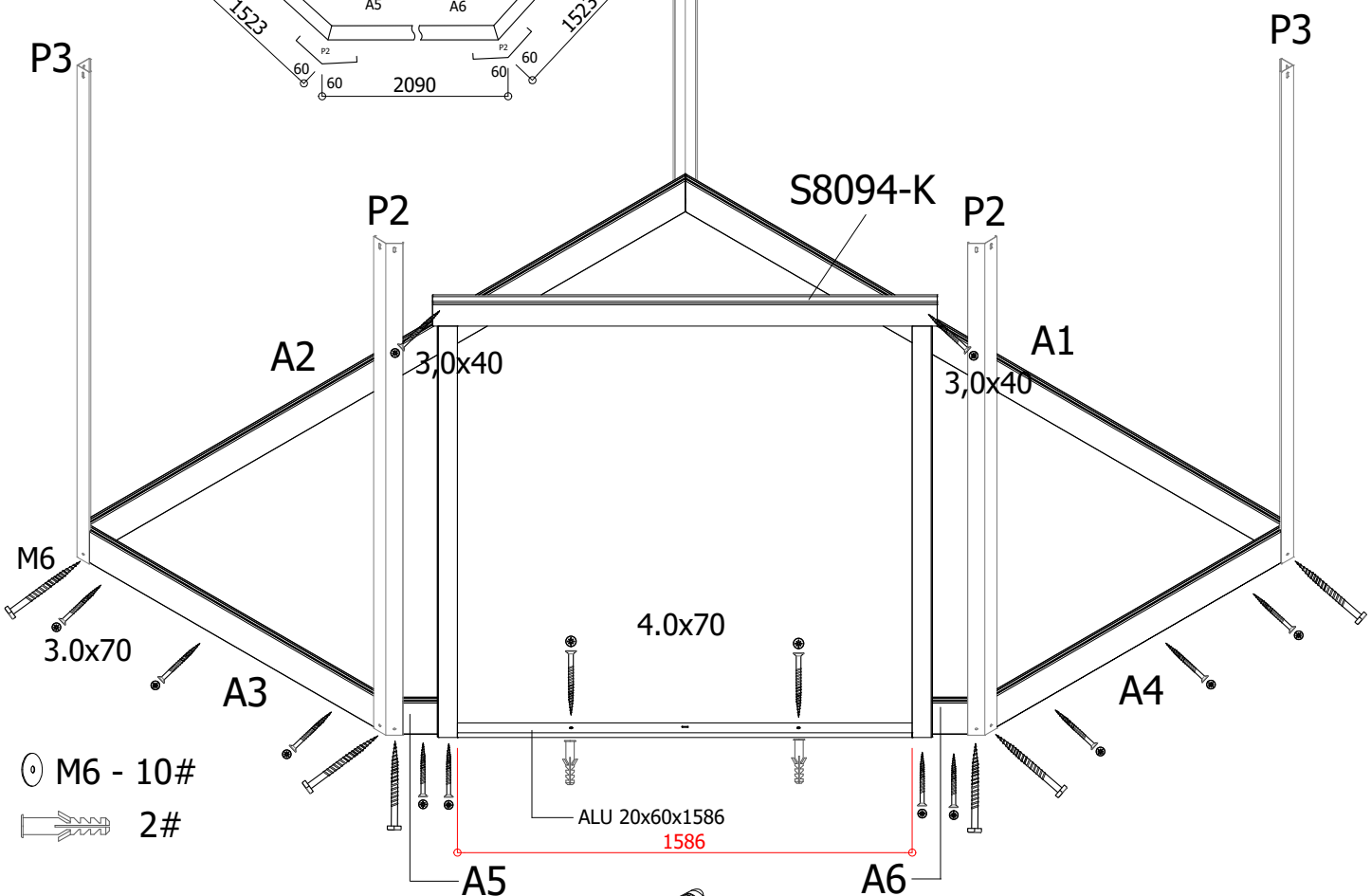
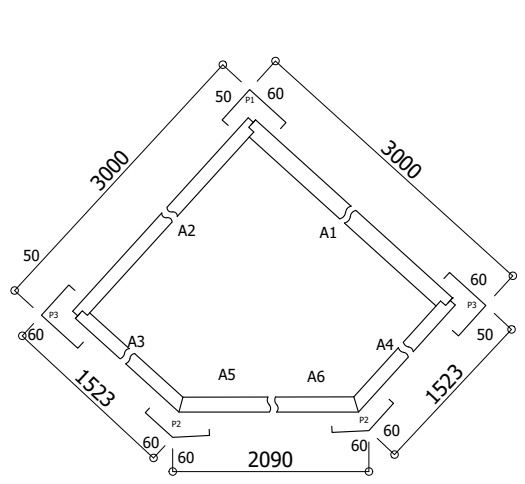

- ⊙ M6 - 10#
- 2#

- ⊙ 3.0 x 40 (40)
- ⊙ 3 x 70 (16)
- ⊙ 4 x 70 (2)
- M6x40 (10)

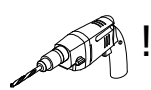

- A1 = 13
- A2 = 13
- A3 = 6
- A5 = 12
- A6 = 12
- A7 = 6
- A8 = 6
- A9 = 6
- A10 = 6
- A13 = 1

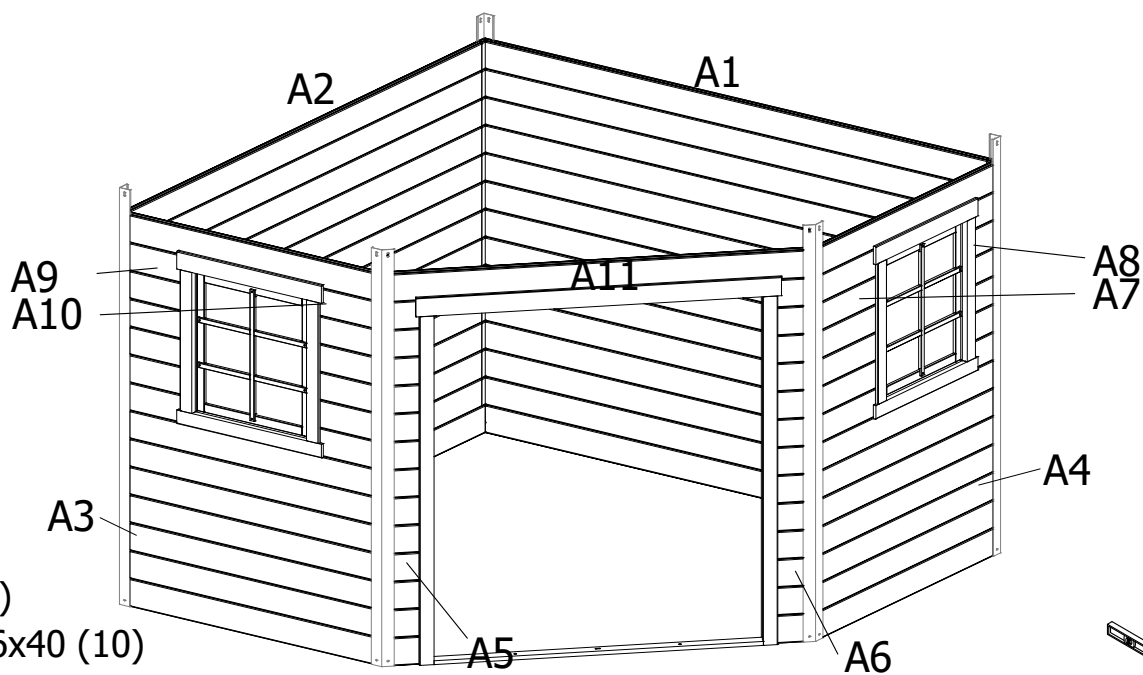

⊙ M6 (10)

➤ M6x40 (10)

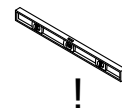

- A1 = 1
- A2 = 1
- A3 = 1
- A5 = 1
- A11 = 2
- A12 = 2
- A13 = 1
- A14 = 1
- A15 = 1
- A16 = 1

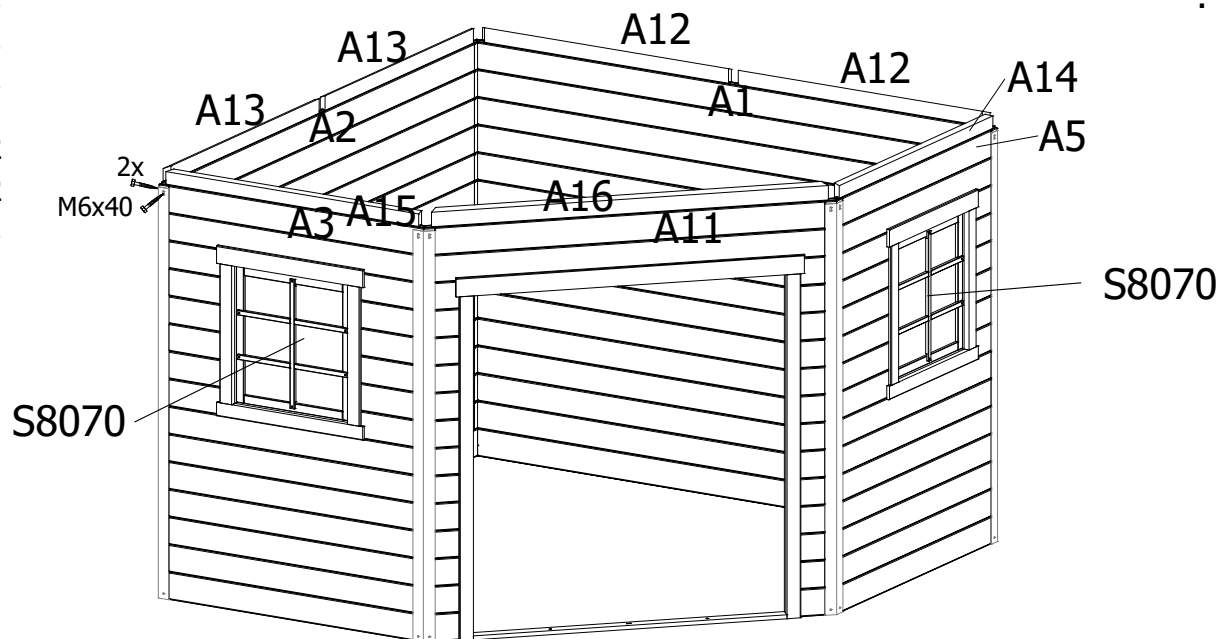

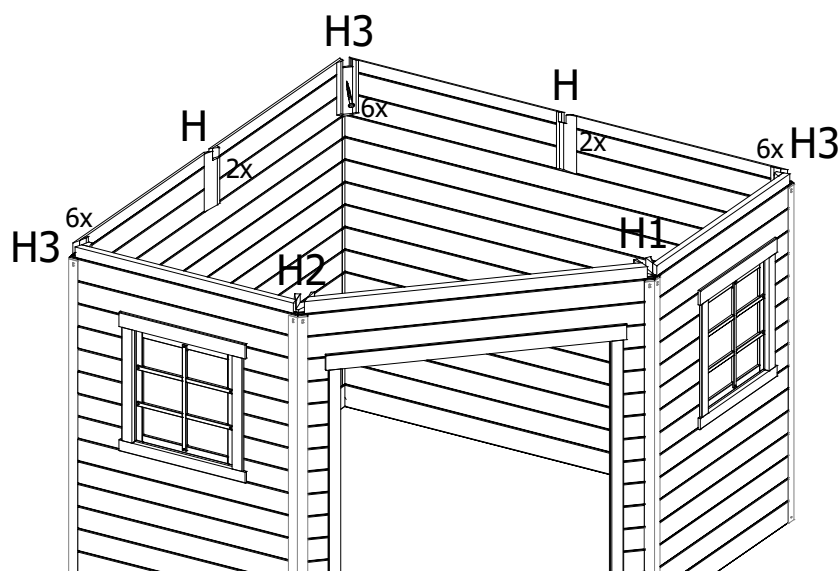

- H = 2
- H1 = 1
- H2 = 1
- H3 = 3



➤ 4x50 (30)

- D1 = 1
- D2 = 3
- D3-L = 1
- D3-P = 1
- D4 = 2

-  5 x 70 (14)
-  5 x 90 (7)

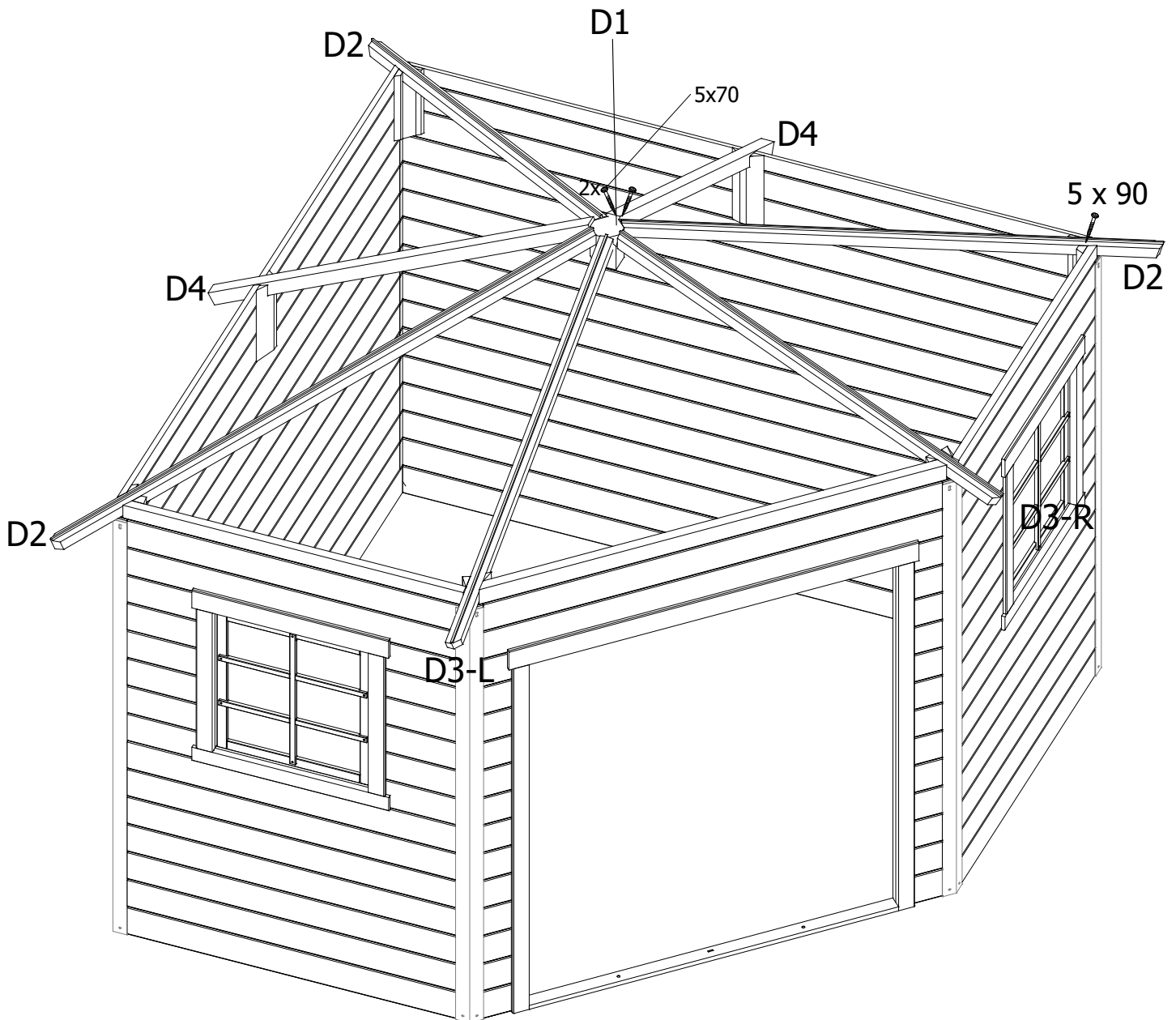
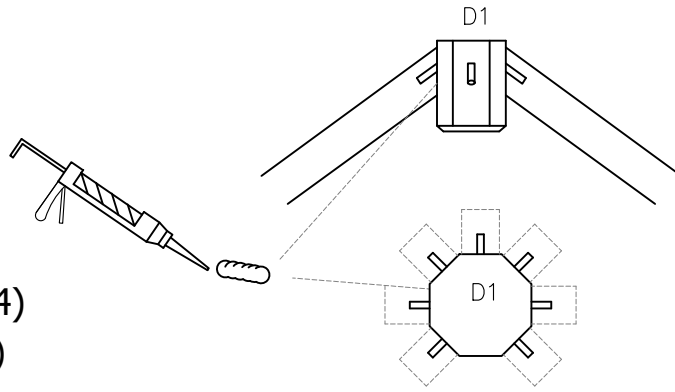

S8207

$F1 = F1/1 + F1/2$
 $F2 = F2/1 + F2/2$
 $F3 = F3/1 + F3/2$
 $F4 = F4/1 + F4/2$

#260

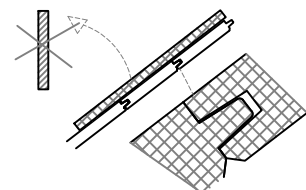
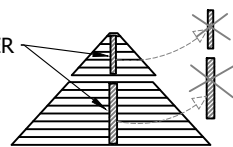
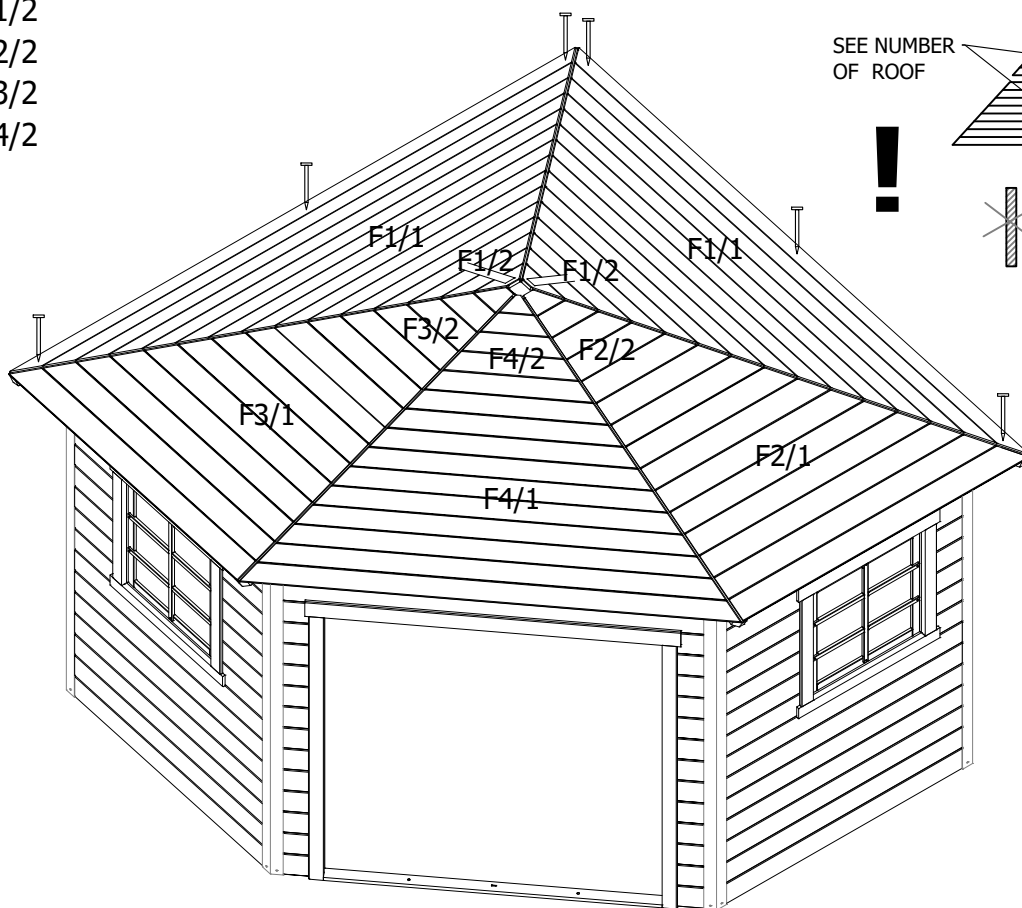

$M1 = 2$
 $M2 = 2$
 $M3 = 1$

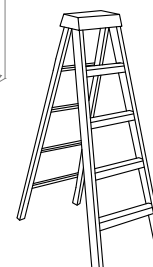
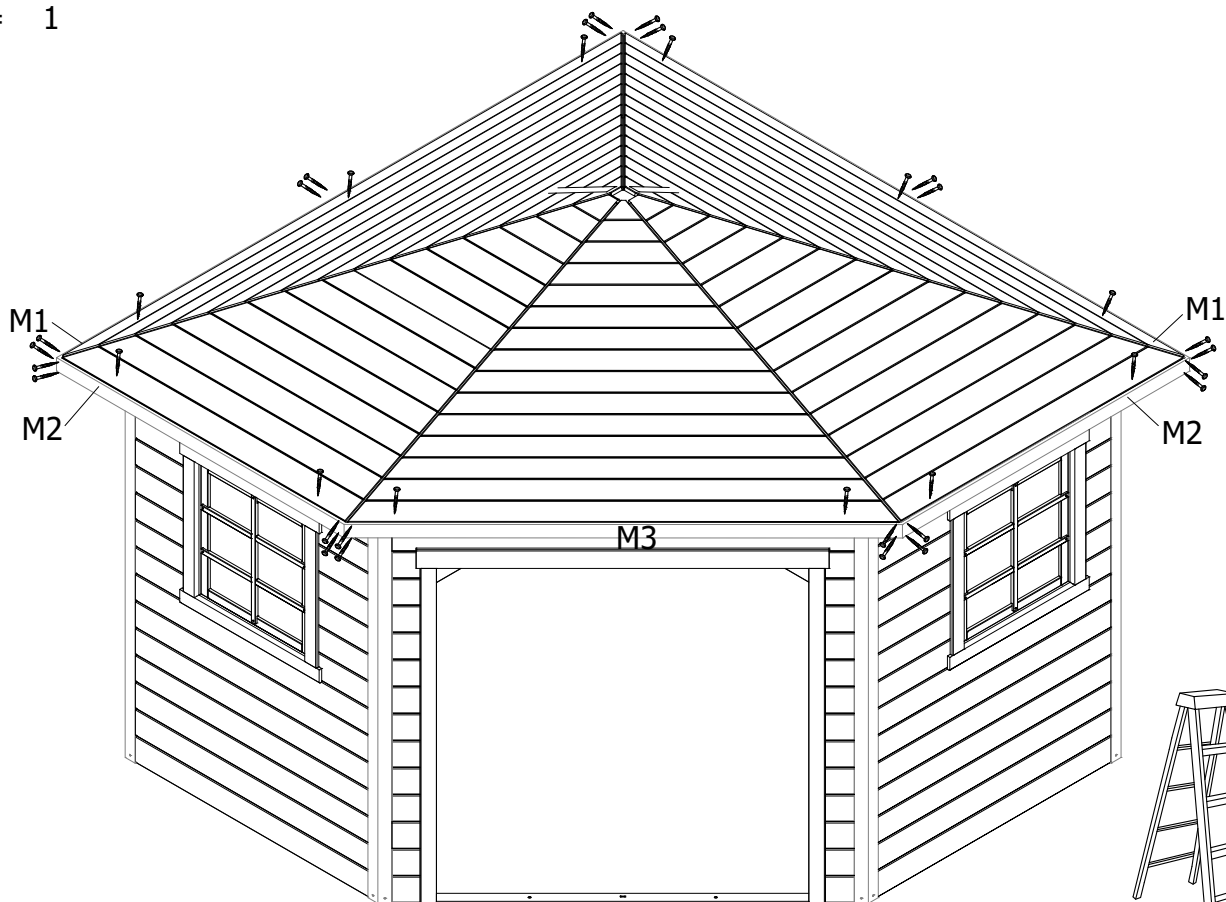

⚓ 3,5 x 35 (32)

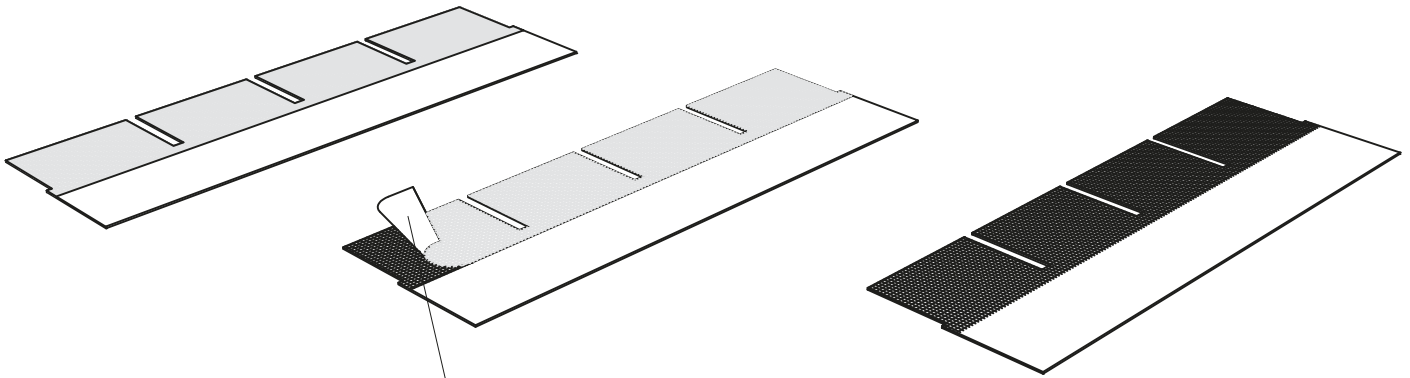

Folie op achterzijde verwijderen
Retirez le film plastique au dos
Remove the foil on the back
Entfernen Sie die Folie auf der Rückseite

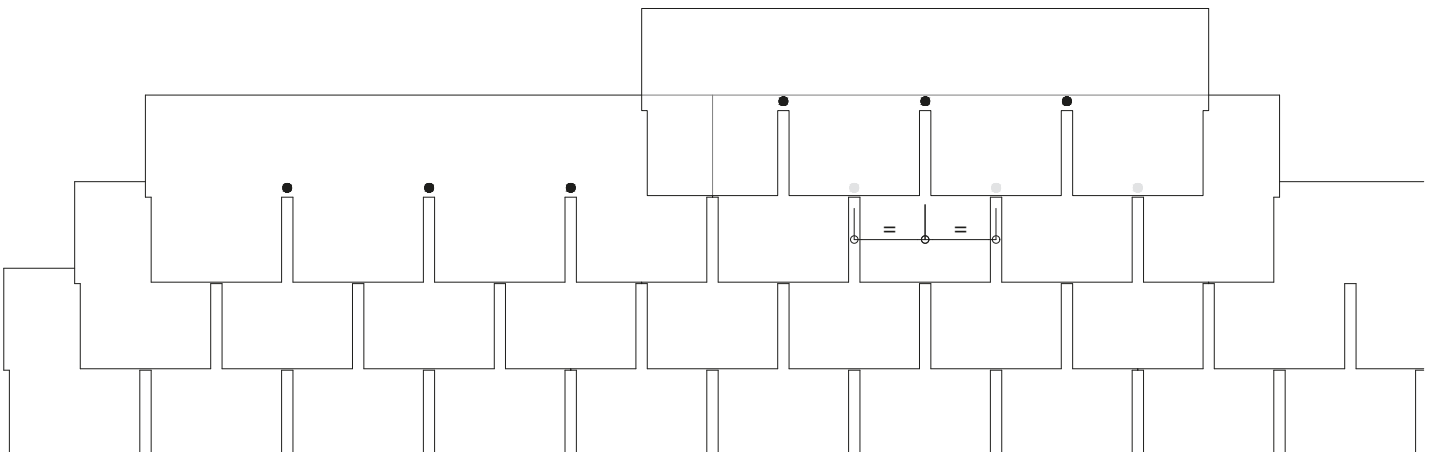
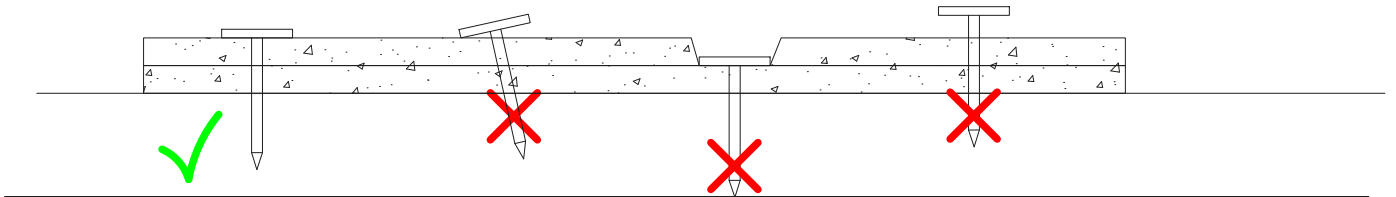

S577

SOLID
creating outdoor comfort

⇒ 3.0 x 15 # 70 /m²

1

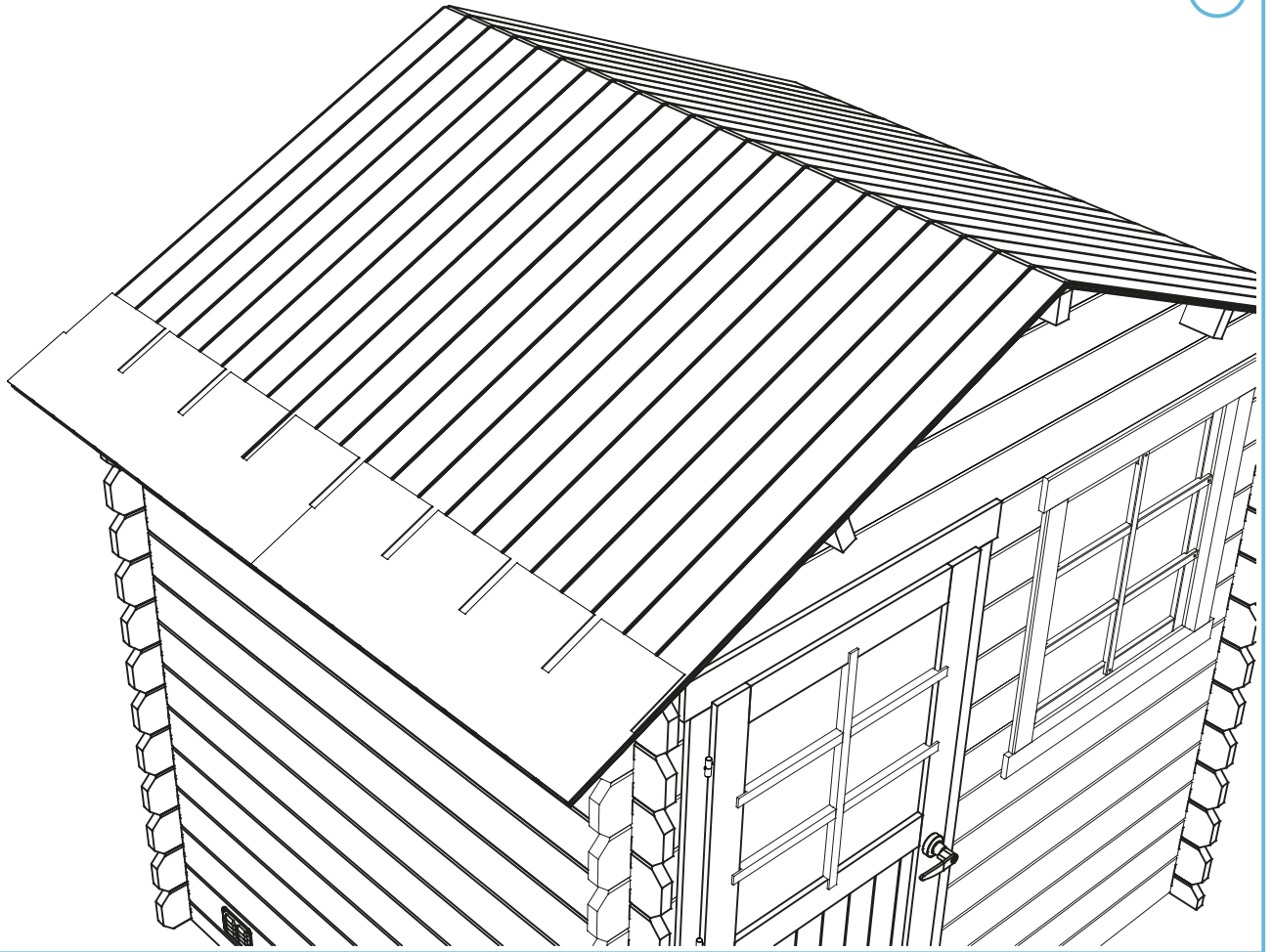

2

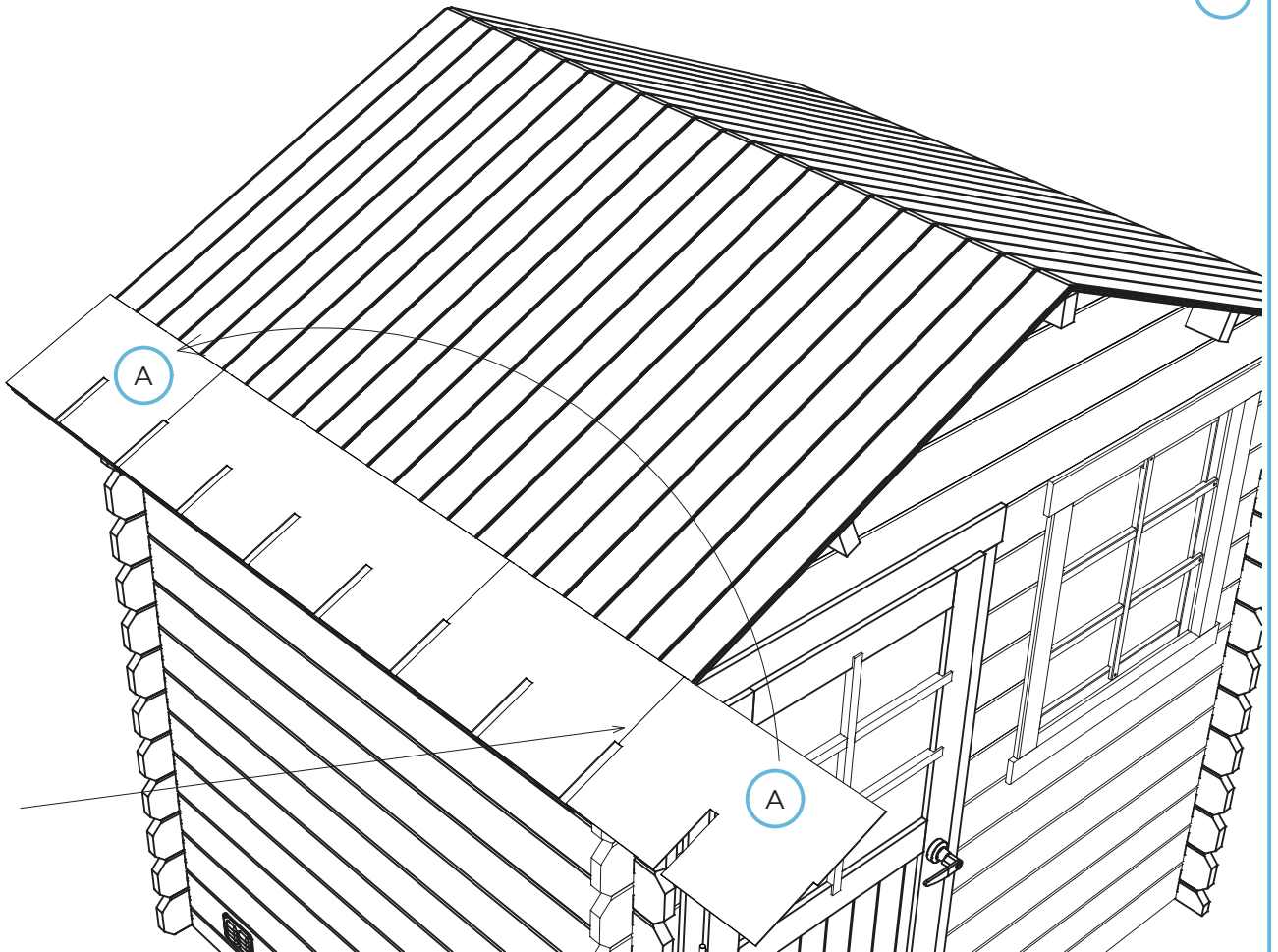

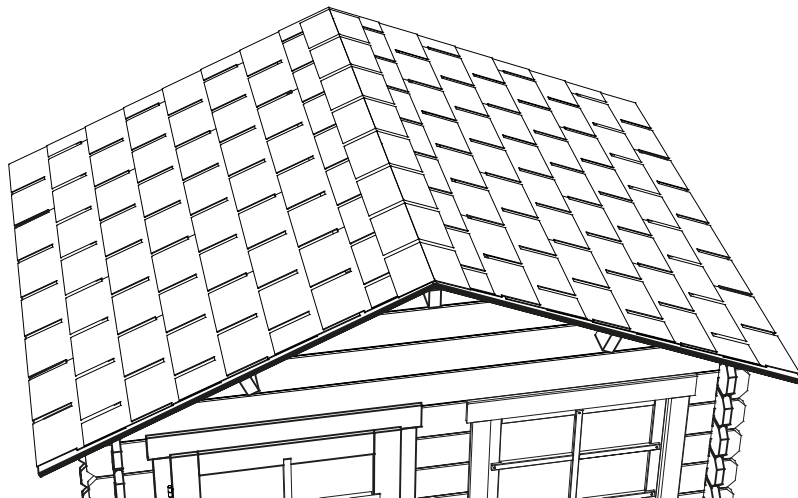
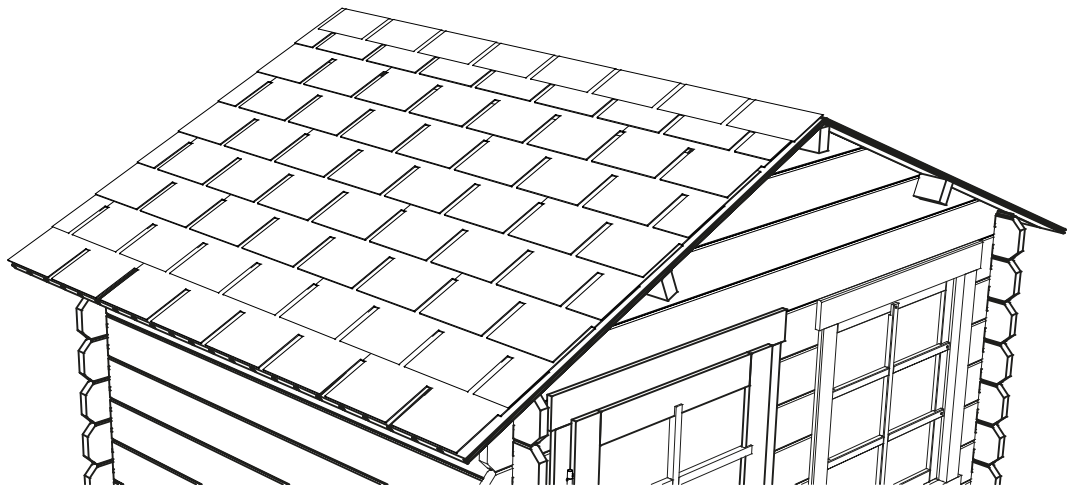
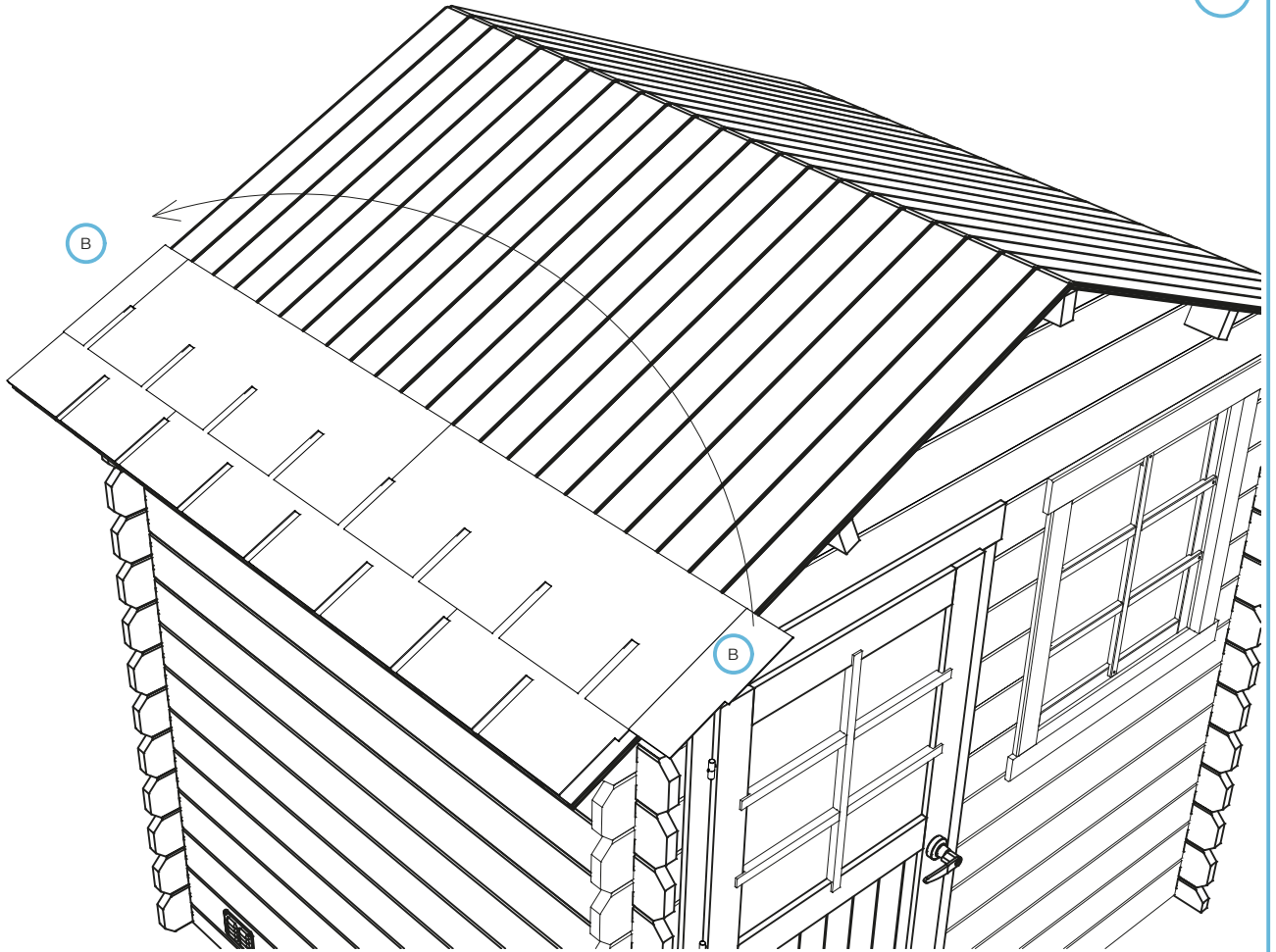

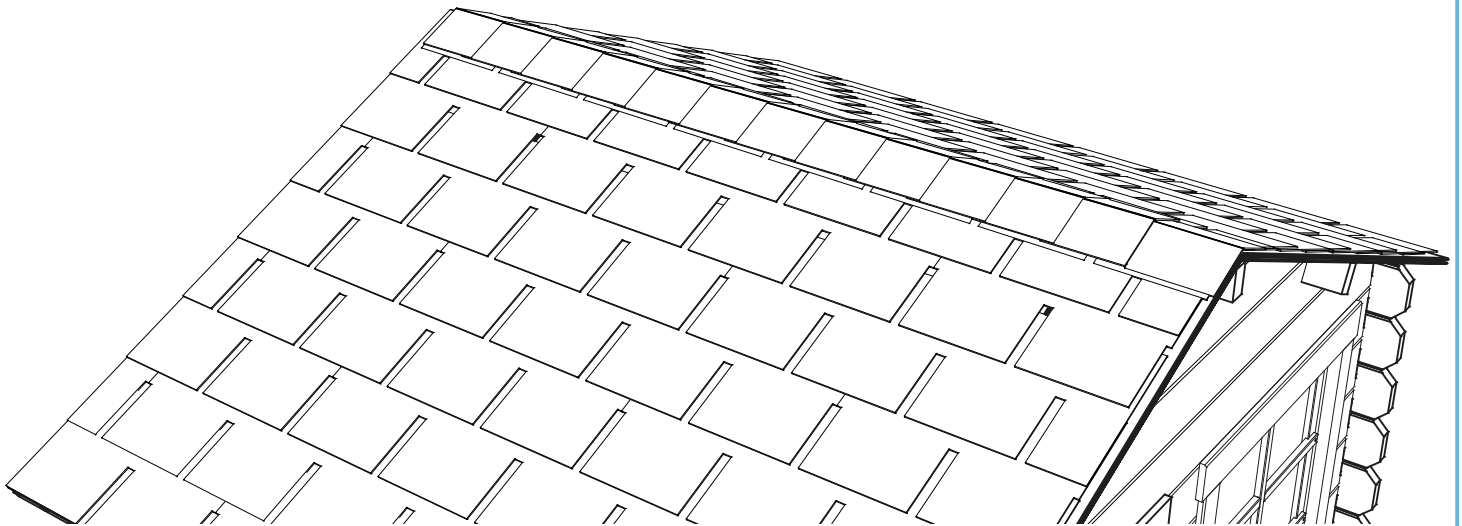
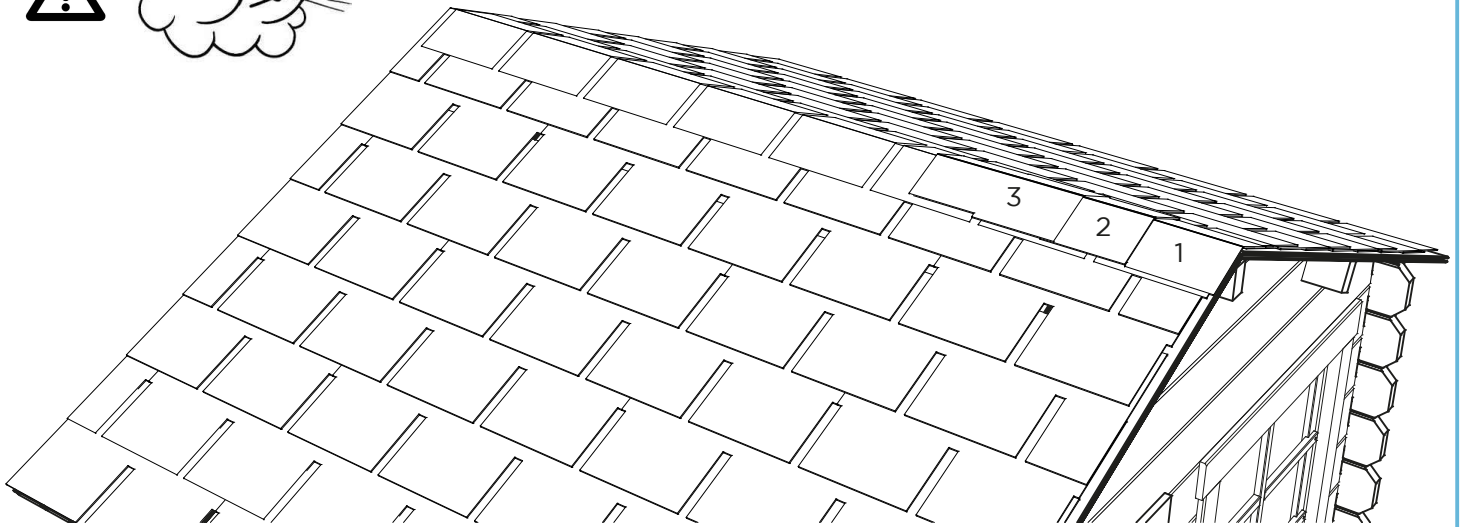
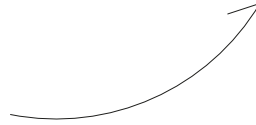
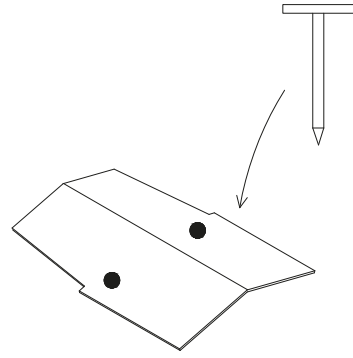
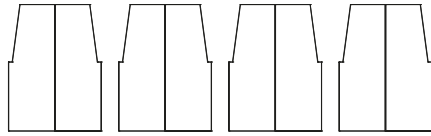
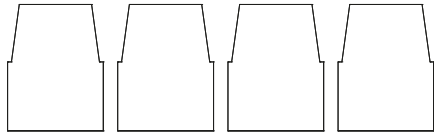
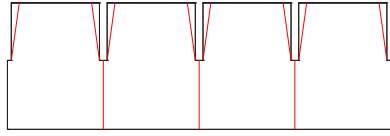

O = 7

 #+-360

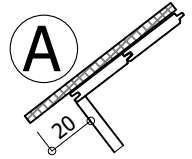
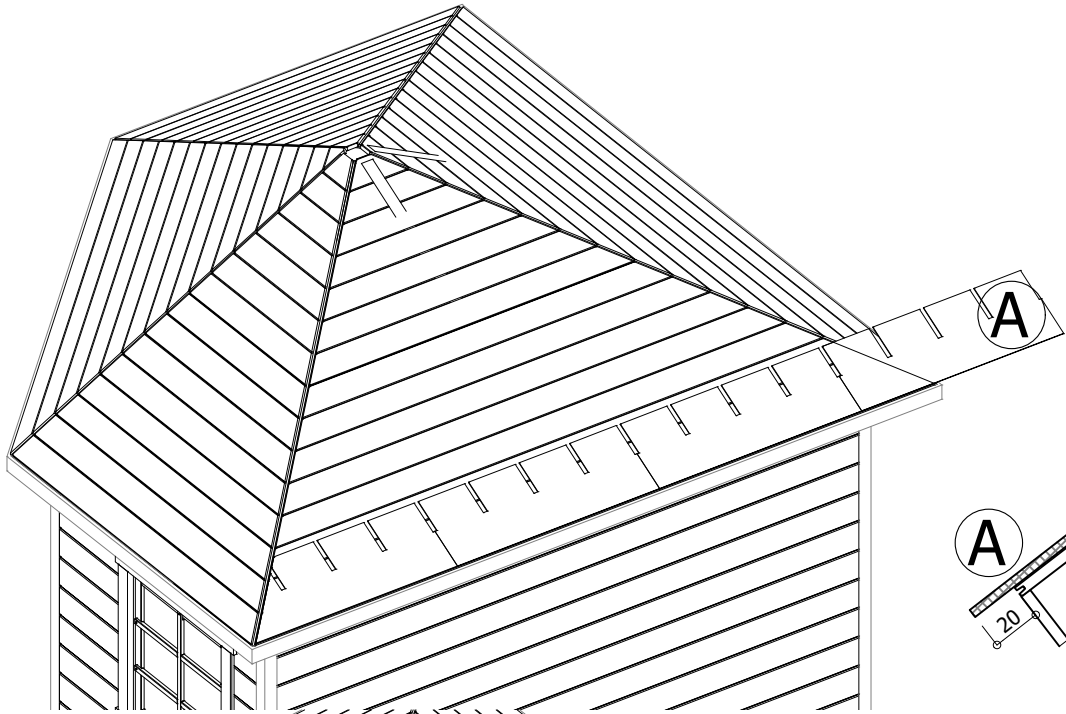

!

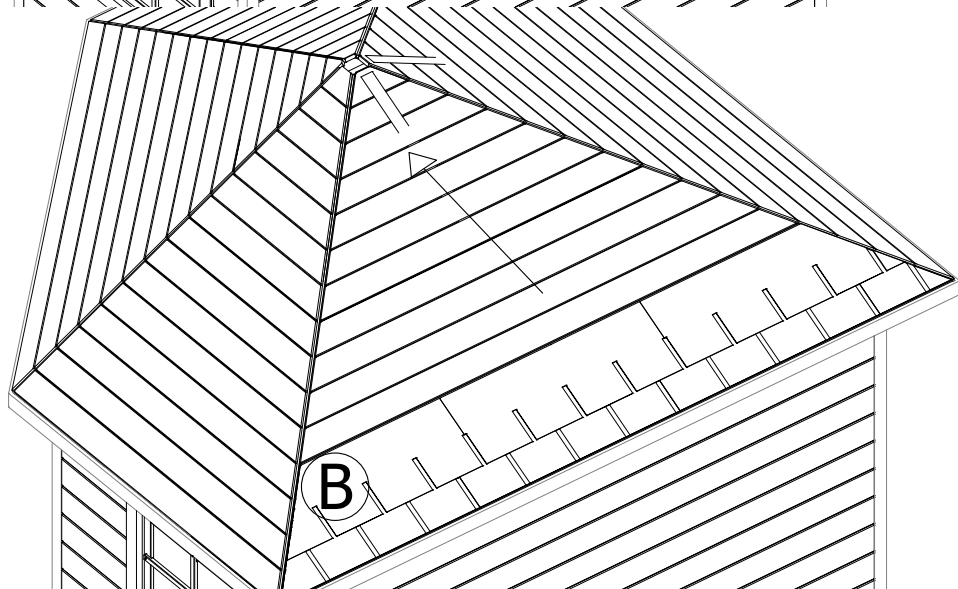
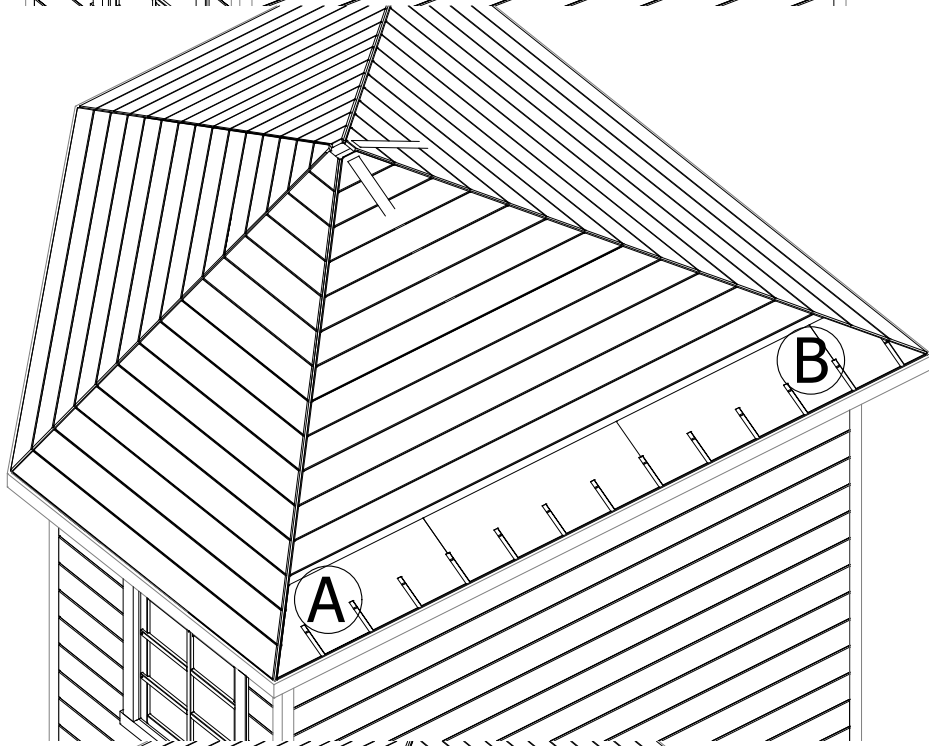

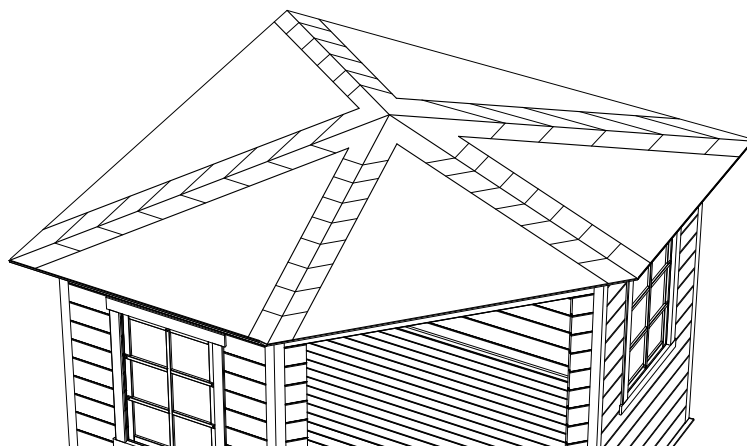
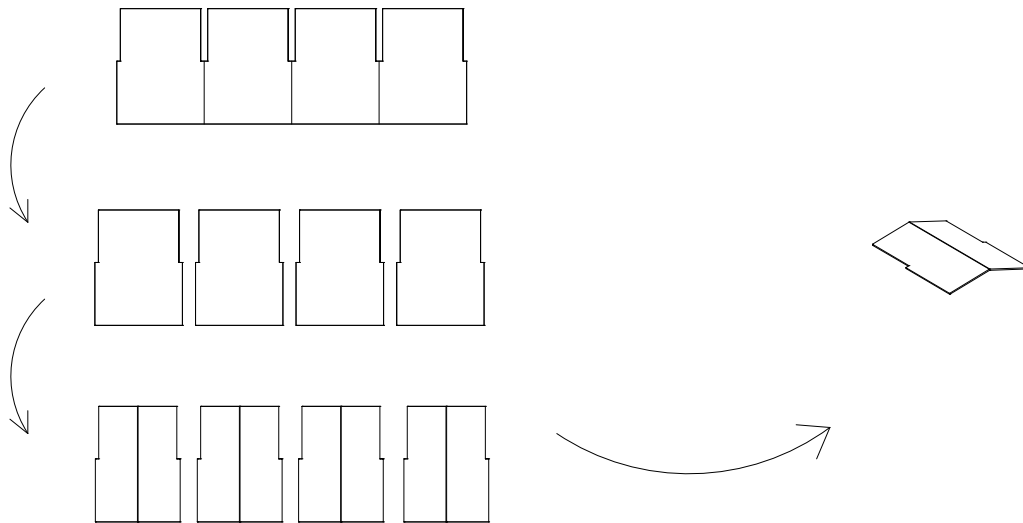
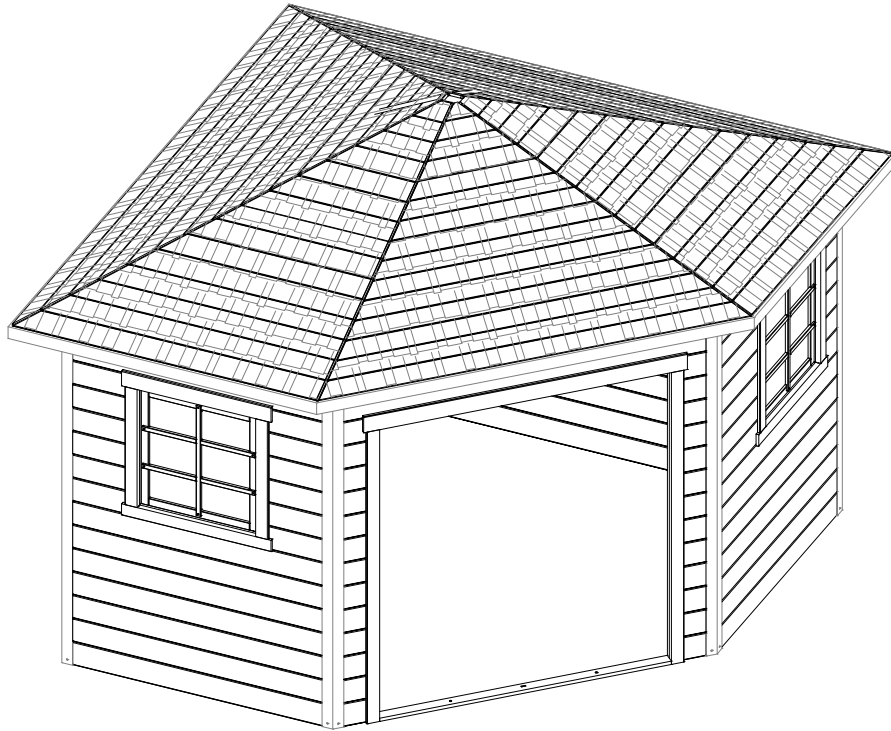

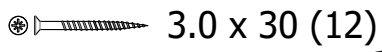
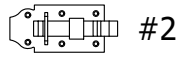

S8094



!

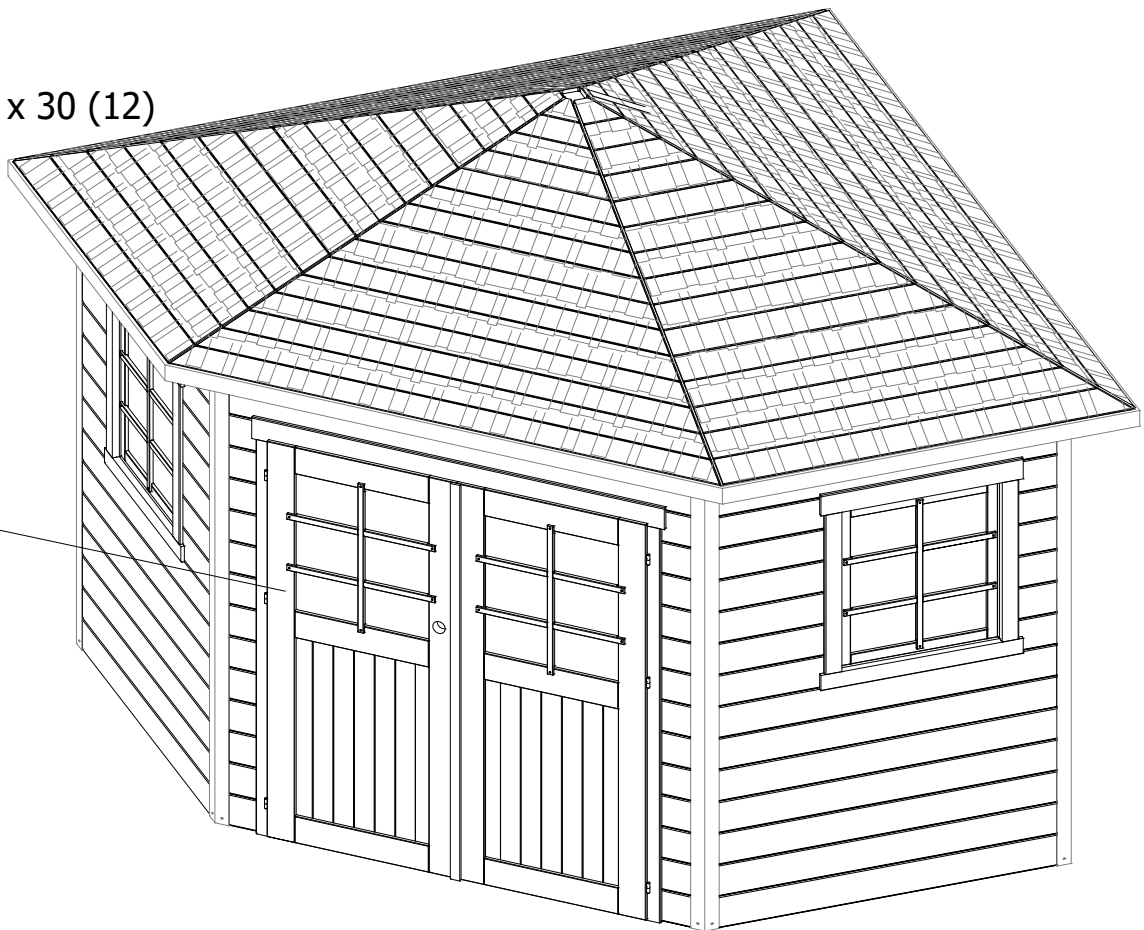

D5

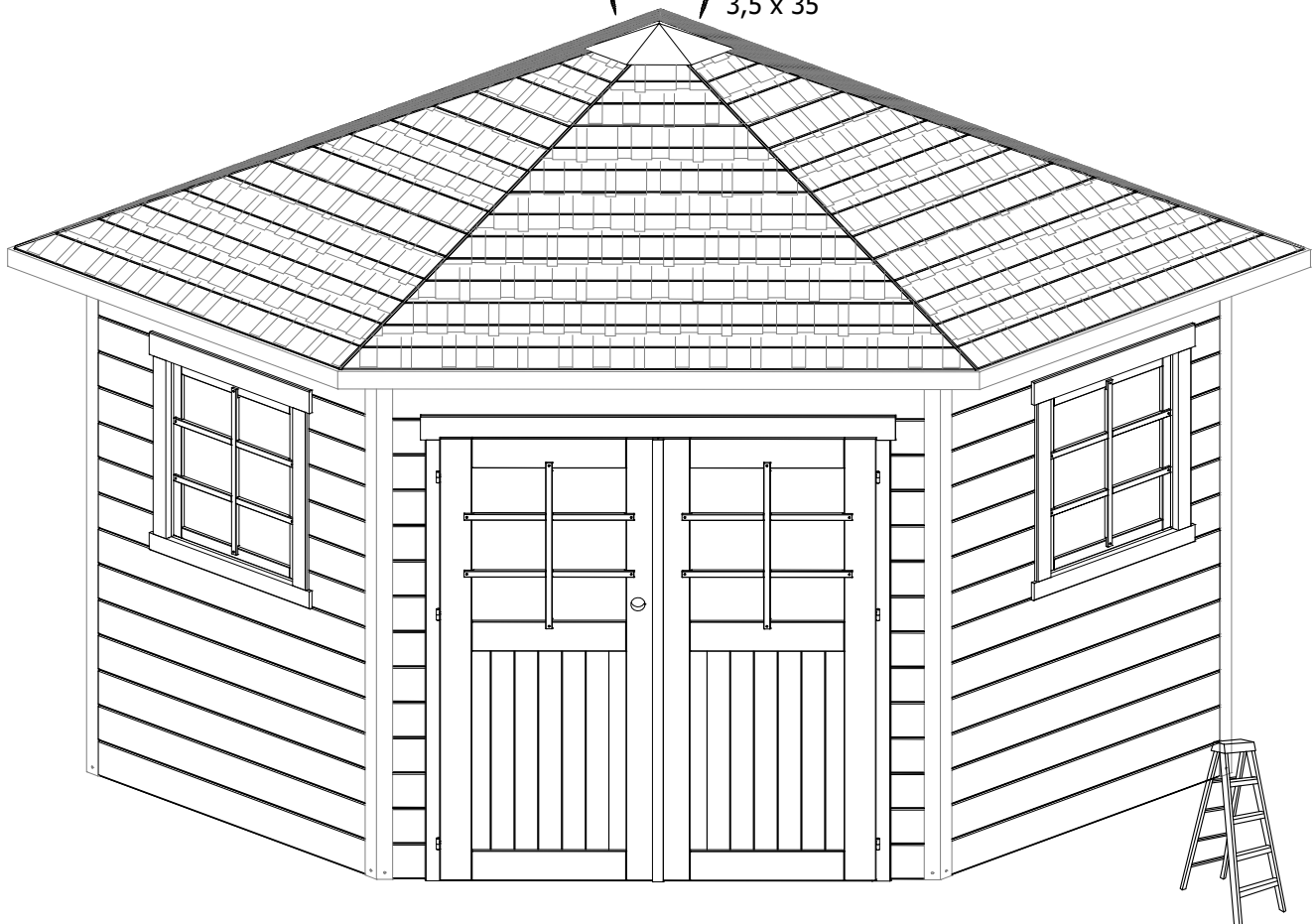
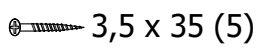

S80201 1

