

Bemerkung: die Ansicht von Turen, Fenster und anderen Teilen kann abweichen von diesem Bild

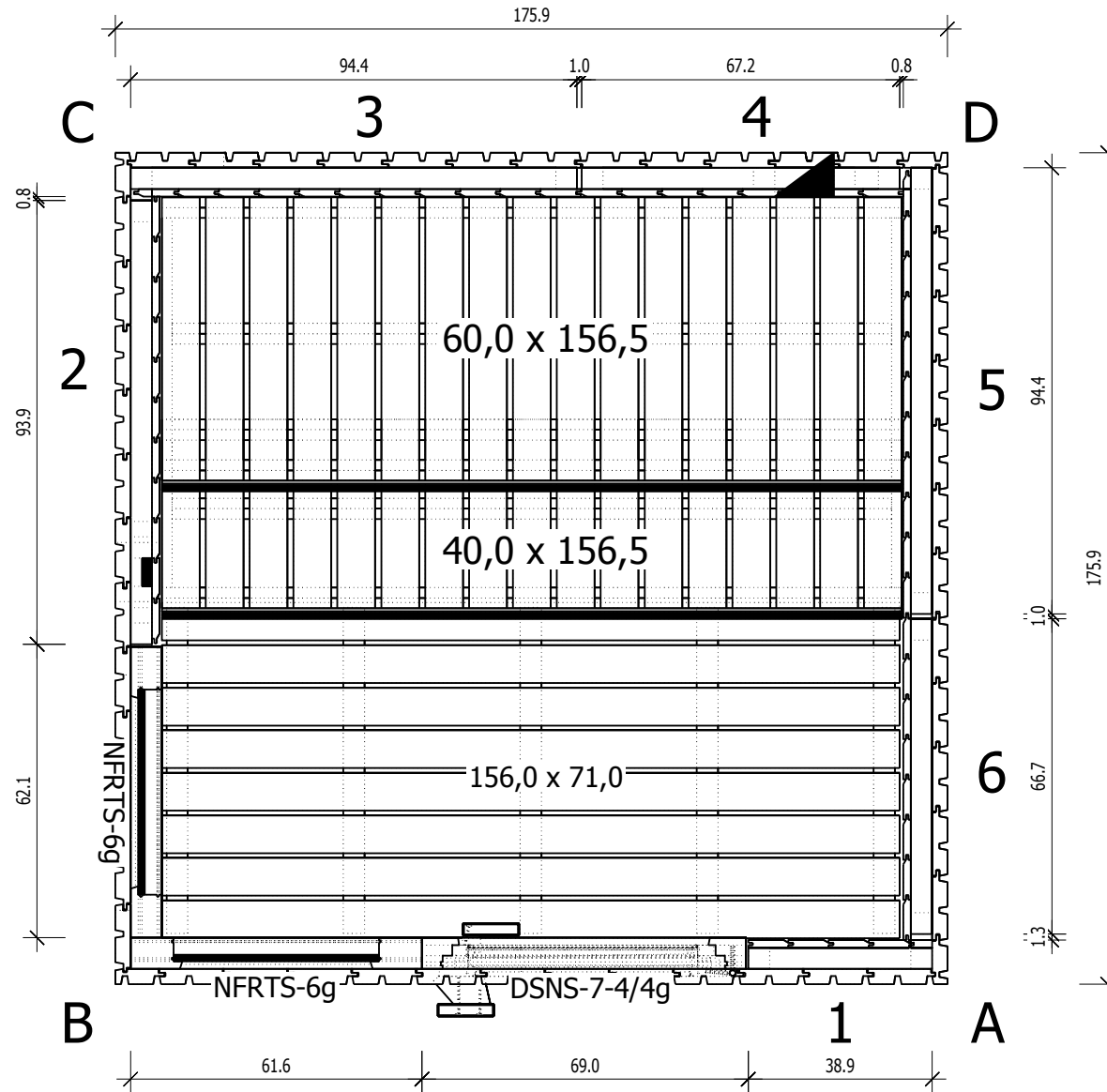

Bemerkung: die Ansicht von Turen, Fenster und anderen Teilen kann abweichen von diesem Bild

# Grundriss



# Schnitt

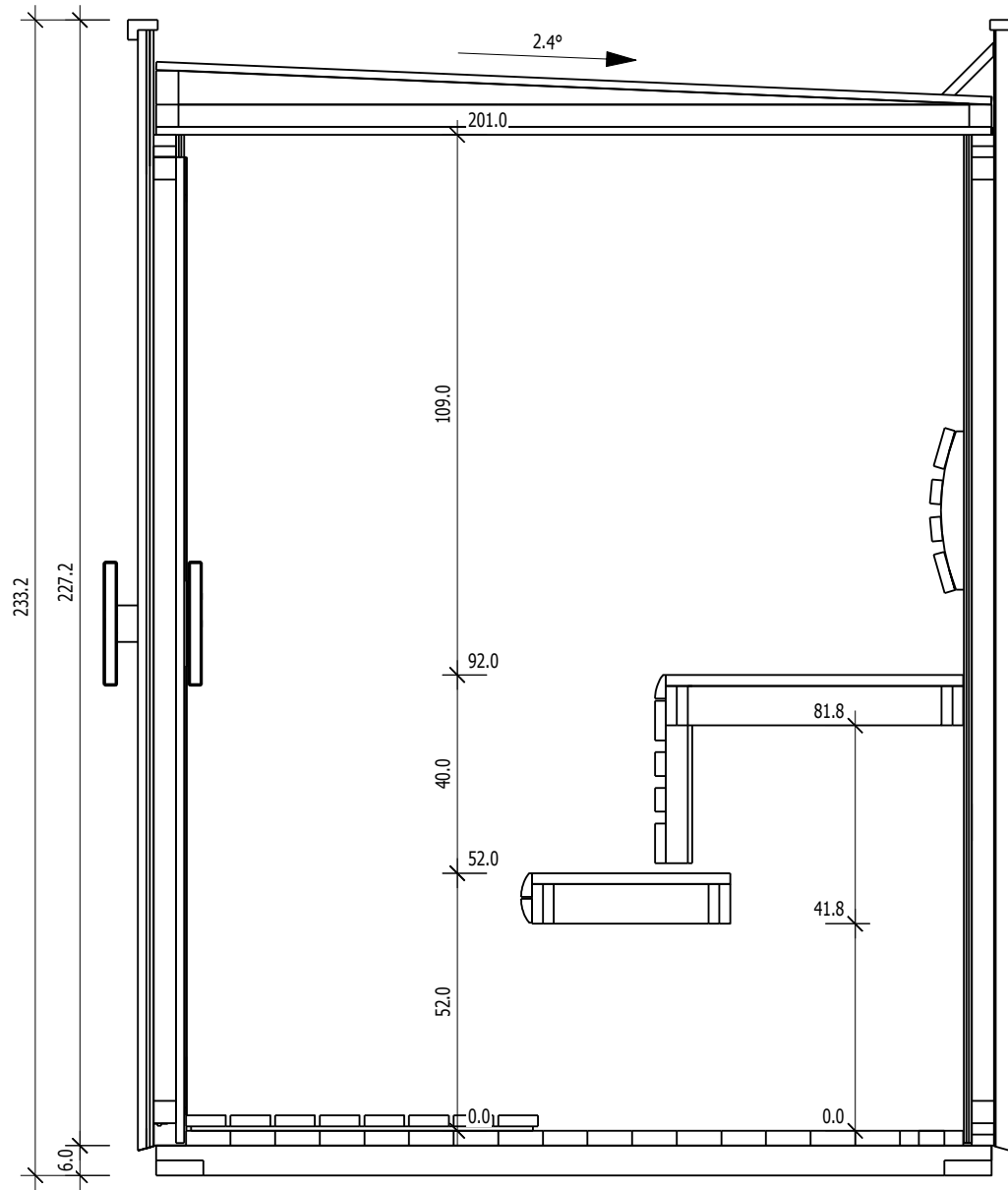

# Grundrahmen

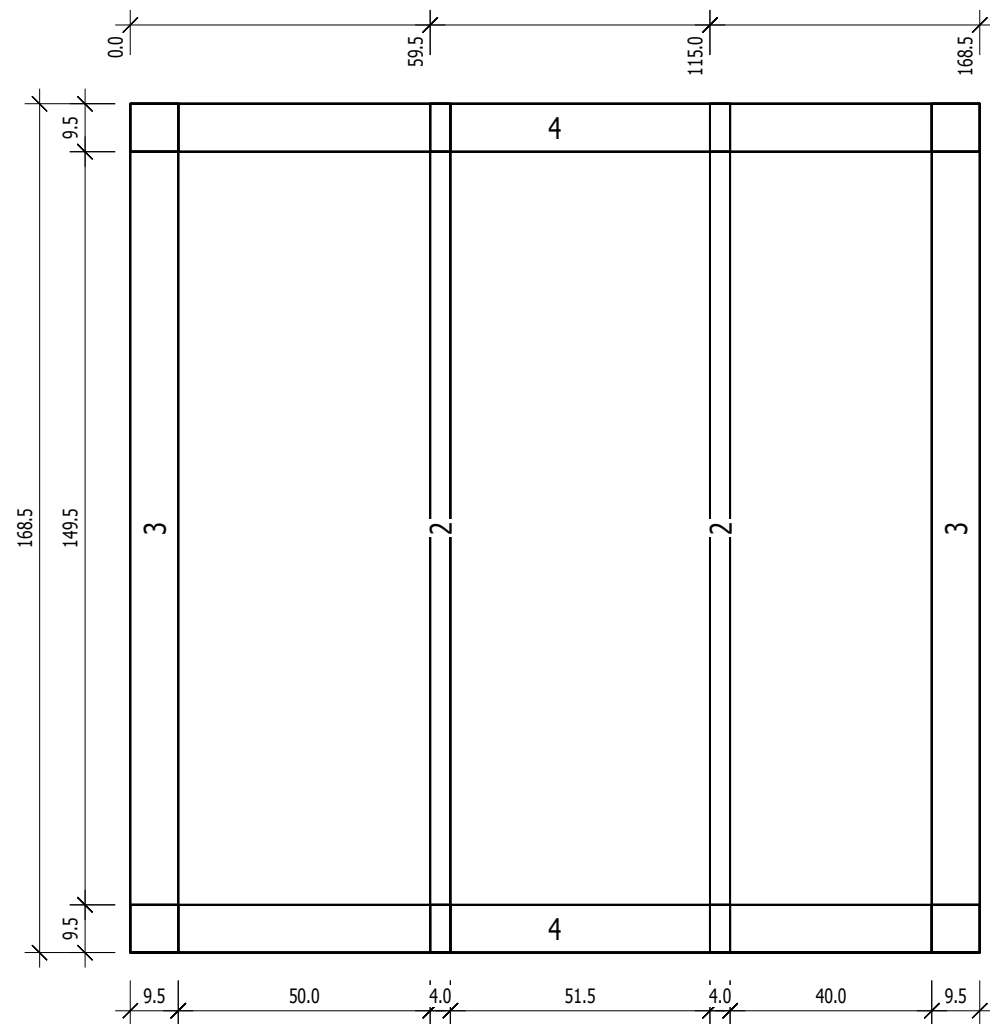

Nr.	B [cm]	H [cm]	L [cm]	Psc
2	4,0	6,0	168,5	2
3	9,5	6,0	168,5	2
4	9,5	6,0	168,5	2

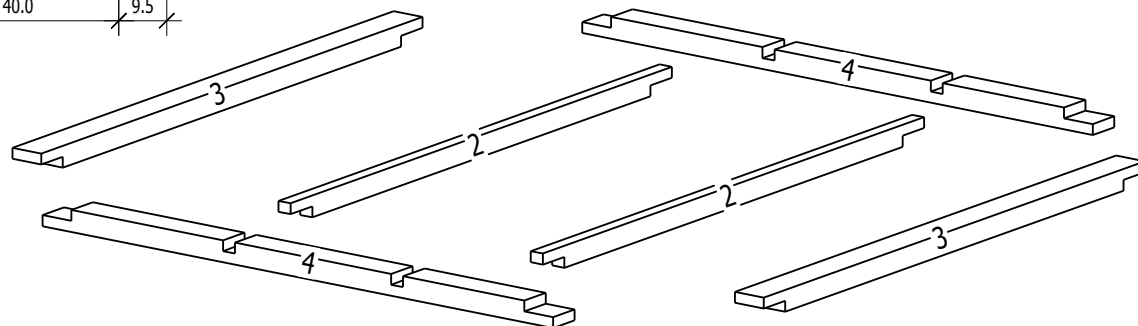

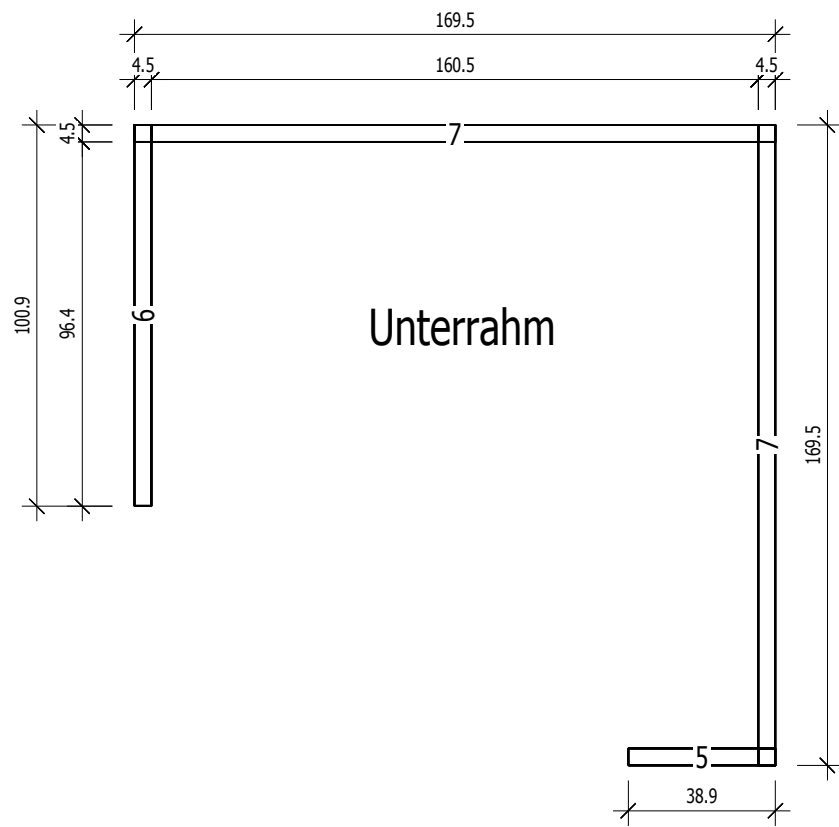

Unterrahm

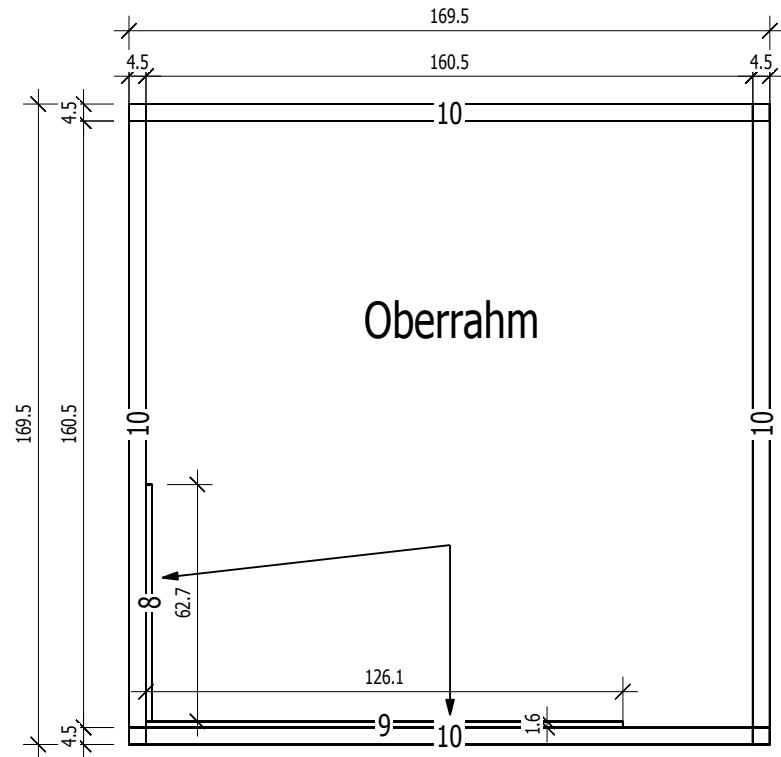

Oberrahm

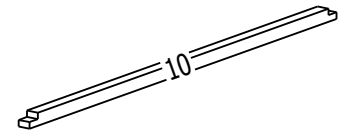
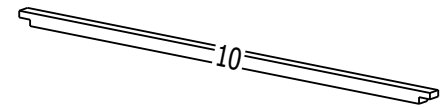
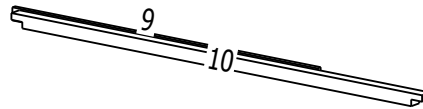
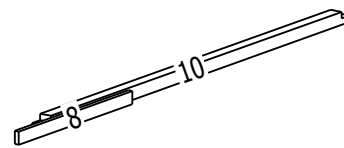
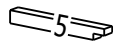
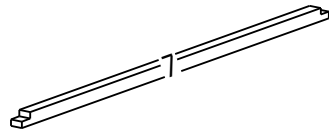
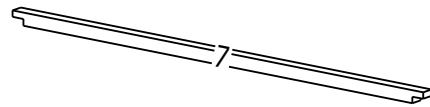
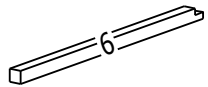

# Dachelemente

