

Montbrun

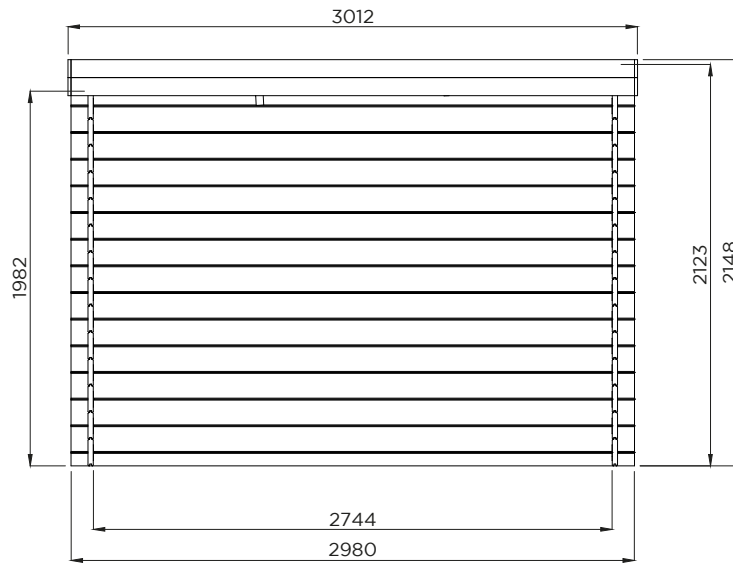

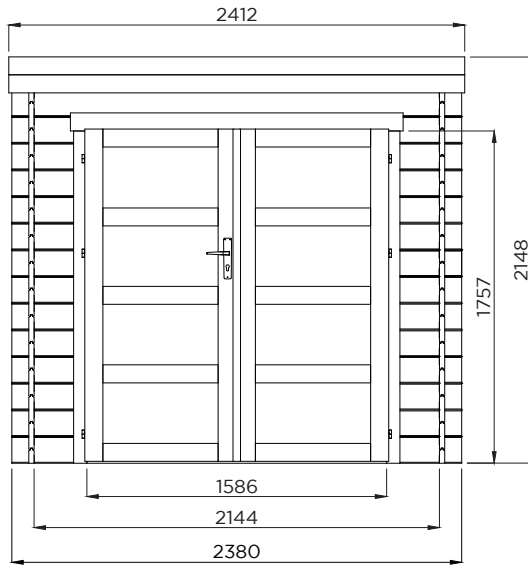



19-140-0095-0/S9122



Deuropening / Embrasure de porte / Doorway : 1586
x
1757

Stuklijst / Liste des pièces / Bill of material

1

	Ref.	Index	#
	A	WW028x149-STPP-IF1-0-2980	2
	B	WW028x149-S1IF-000-0-0350	26
	E	WW028x149-S2IF-000-0-2980	26
	G	WW028x149-S2IF-000-0-2380	16
	I	WW028x079-SDM-000-0-2980	2
	J	WW016x095-PLA-000-0-2950	27

ALTERNATIEF :

Het kan productiematig zijn dat er andere planchettes J in de verpakking zitten.
De referentie is dan WW016x120-PLA-000-0-2950 => # 22 stuks

ALTERNATIVE :

Il peut être lié à la production que d'autres planchettes J soient incluses dans l'emballage.
La référence est alors WW016x120-PLA-000-0-2950 => # 22 pièces



ALTERNATIVE :

It may be production-related that other planchettes J are included in the package.
The reference is then WW016x120-PLA-000-0-2950 => # 22 pieces

ALTERNATIVE :

Es kann produktionsbedingt sein, dass andere Planchetten J im Paket enthalten sind.
Die Referenz ist dann WW016x120-PLA-000-0-2950 => # 22 Stück

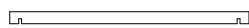

K WW040x120-PT0-000-0-2380 2



M WW016x095-4FA-000-0-3100 8



M1 WW028x040-4FA-000-0-1750 1

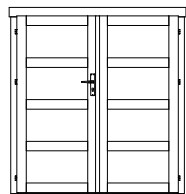

P S8047C28 1

- 1 x S8047
- 1 x S8094-K28
- 1 x WW012x040-2RB-000-0-1757
- 1 x RW020x060-4FA-000-0-1586
- 1 x S618
- 8 x S5245 (glass 345mm x 630mm)
- 1 x S646 + 6 x S6201
- 1 x S673



R S637 2

- 2.8 x 50 #100



R1 S617 2

- 3.5 x 35 #20

PRINCIPE TPP

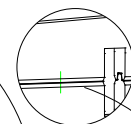
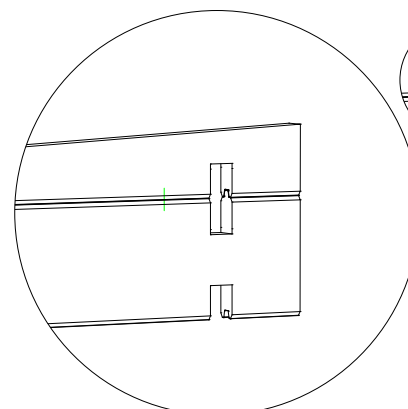
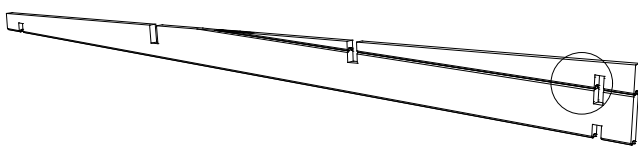

S9122

A = 2
B = 26
E = 26
G = 16
I = 2
K = 2

 2.8 x 50 # 12

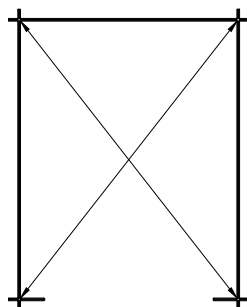
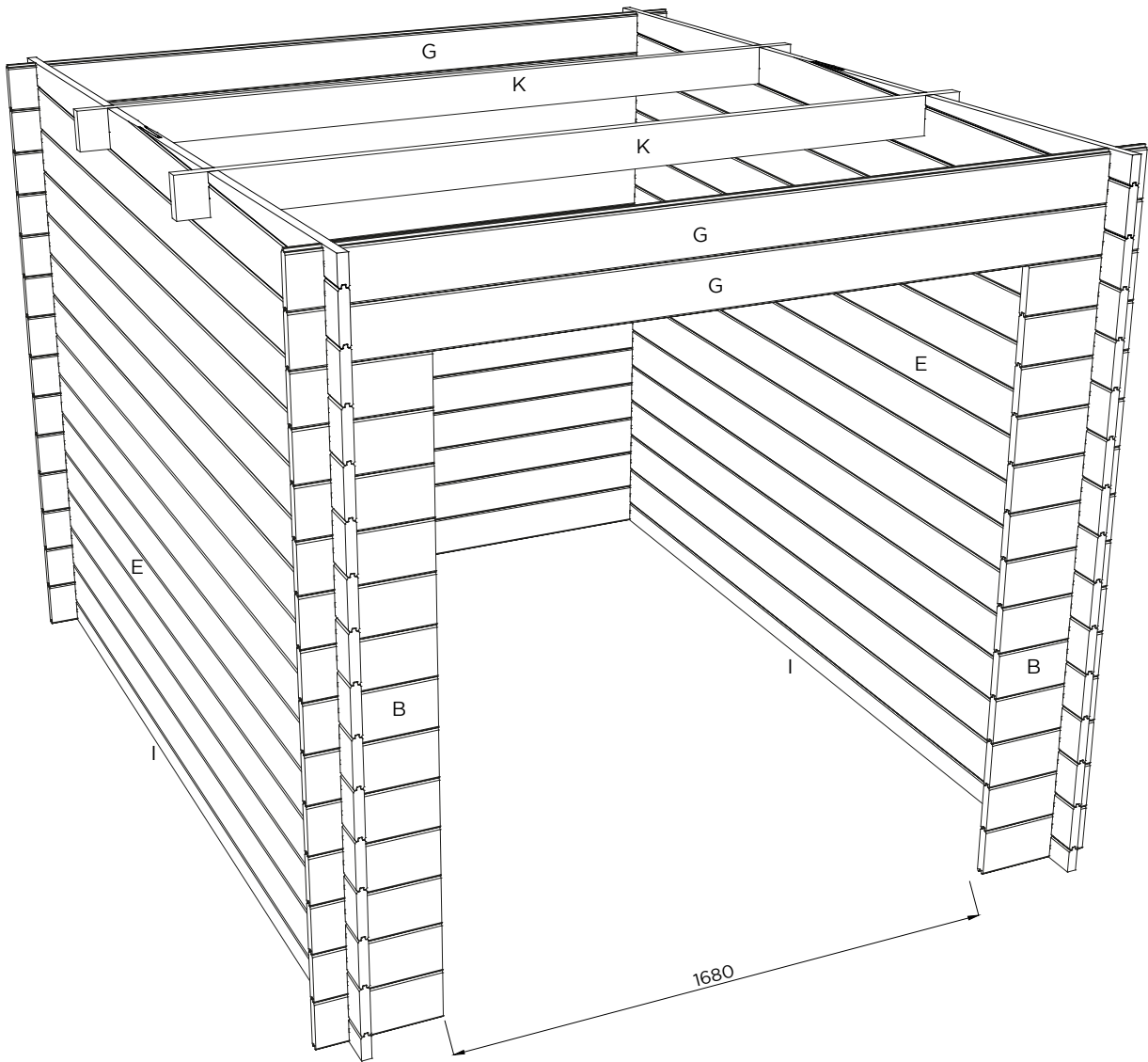

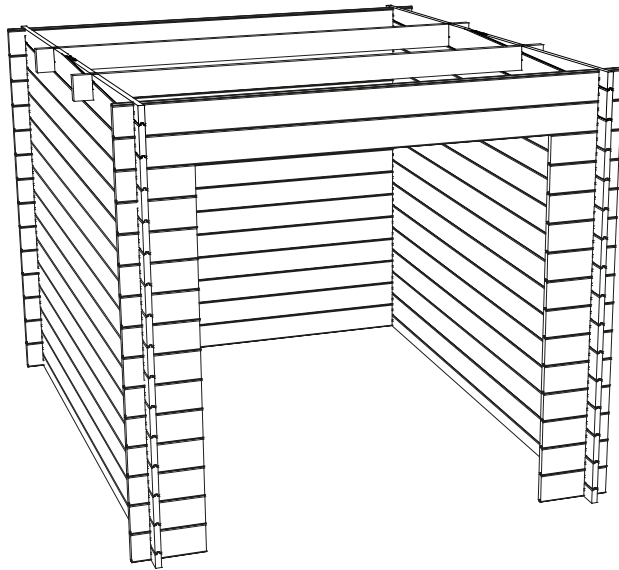

(NL) INFORMATIE :

Het is niet abnormaal dat kleine openingen te zien zijn bij de montage, zowel boven de deur als bij de dakopbouw. Deze zullen na het natuurlijk drogen van het product verdwijnen, hou er evenwel rekening mee dat dit enkele weken kan duren.

(FR) INFORMATION :

Il n'est pas anormal qu'il y ait des ouvertures à voir lors du montage tant au-dessus de la porte et les fenêtres qu'en montant le toit. Ceux-ci disparaîtront après le séchage naturel du produit. Tenez cependant compte que cela peut durer quelques semaines.

(GB) INFORMATION :

It is not unusual that small openings are visible during the assembly, both above the door and in the roof. These will disappear after the natural drying of the product, keep in mind, however, that this may take several weeks.

(D) INFORMATION :

Es ist nicht abnormal, dass beim Aufbau, sowohl oberhalb der Tür als auch beim Dachaufbau kleine Öffnungen zu sehen sind. Nach der natürlichen Trocknung des Produktes werden diese verschwinden. Berücksichtigen Sie aber, dass dies einige Wochen in Anspruch nehmen kann.

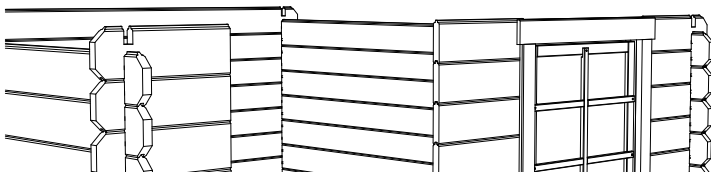
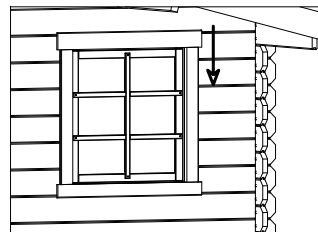
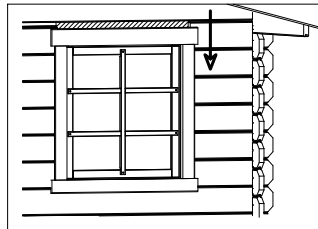
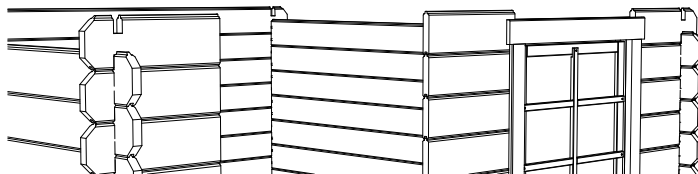

S9122

J = 27 of/ou/or/oder 22

 2.8 x 50 # 108

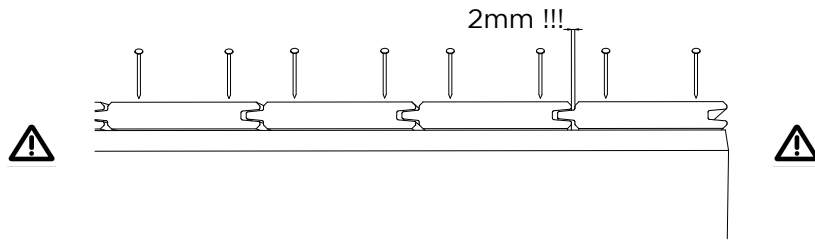
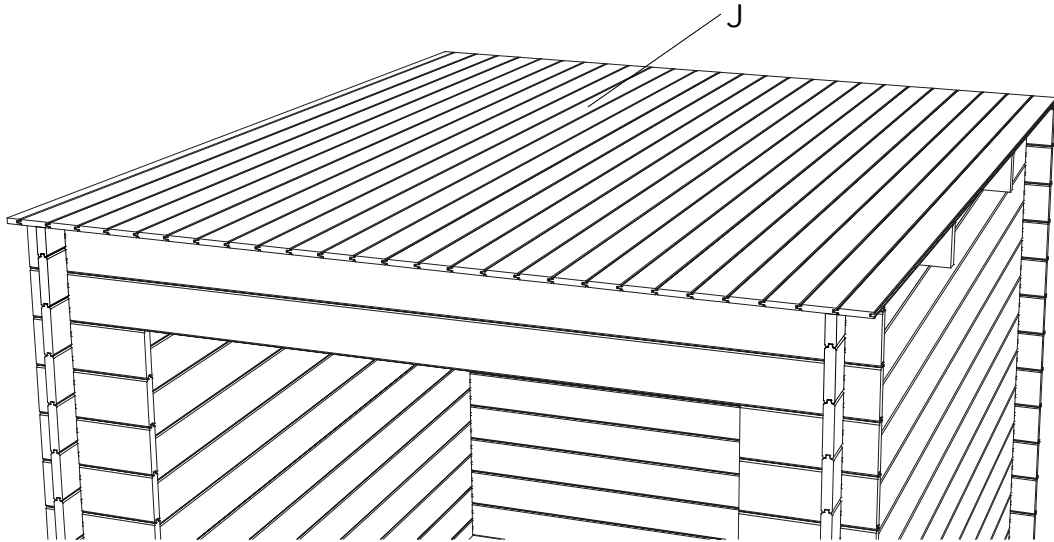

M = 8
M1 = 1
R1 = 24

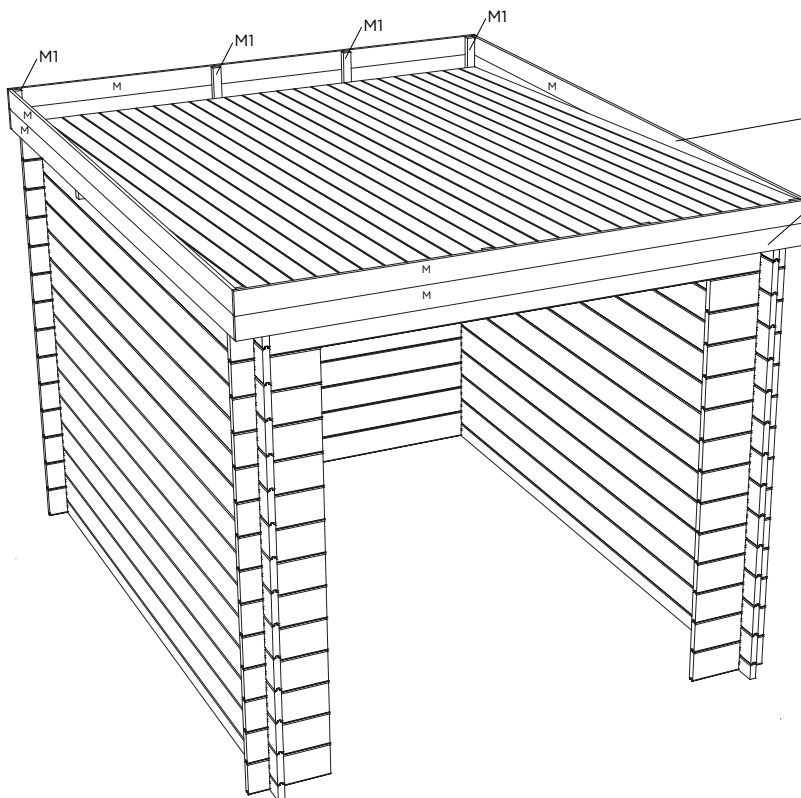
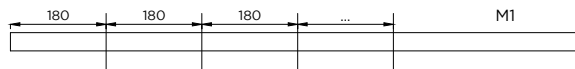

M
Af te korten in lengte !!!!
À raccourcir en longueur !!!!
To be shortened in length !!!!

S8047C28

1

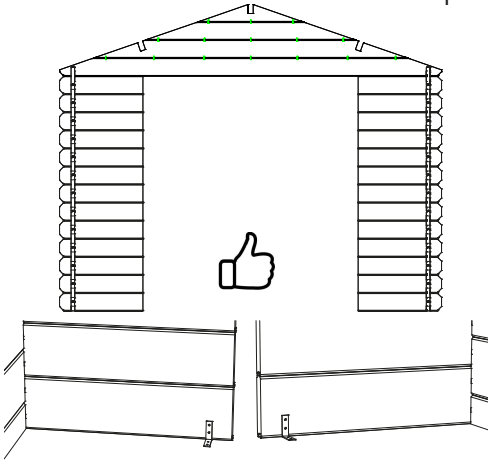

2

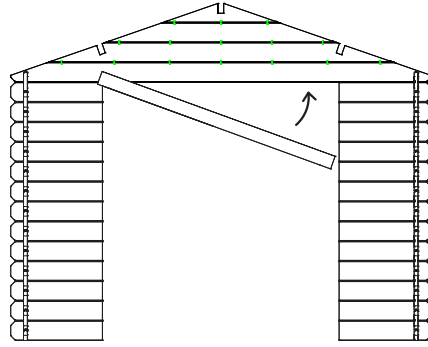

3

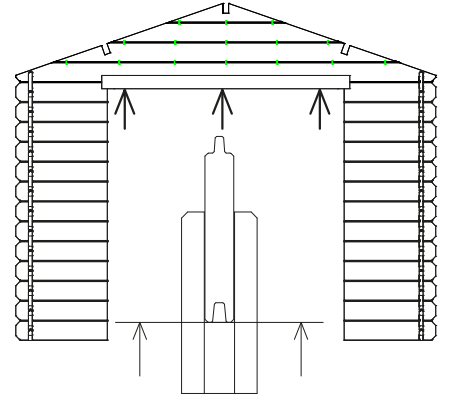

4

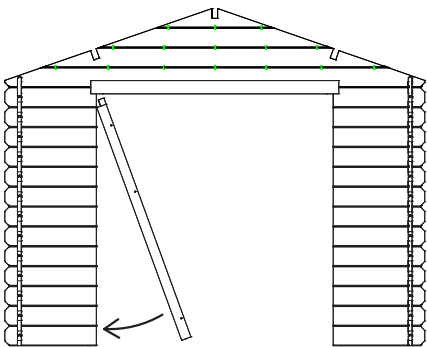

5

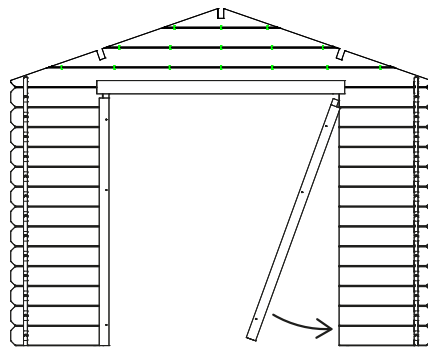

6

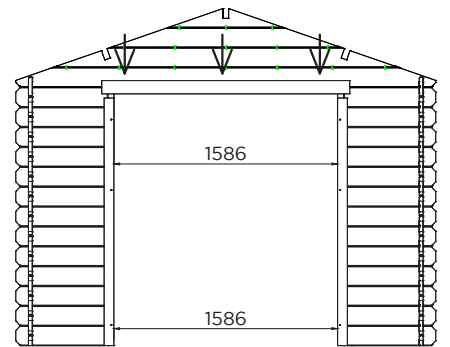

7

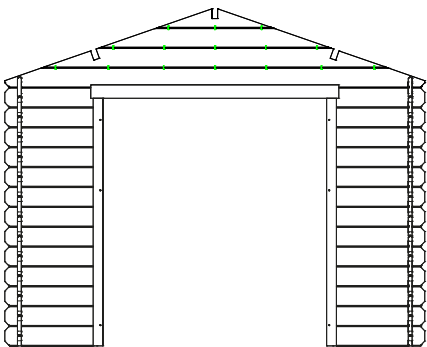

8

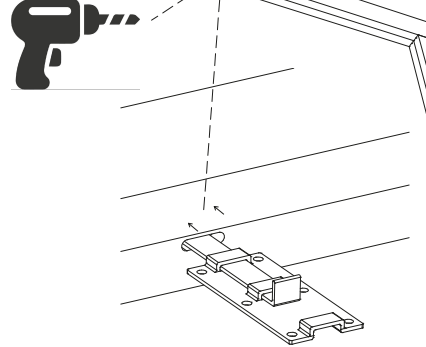

9

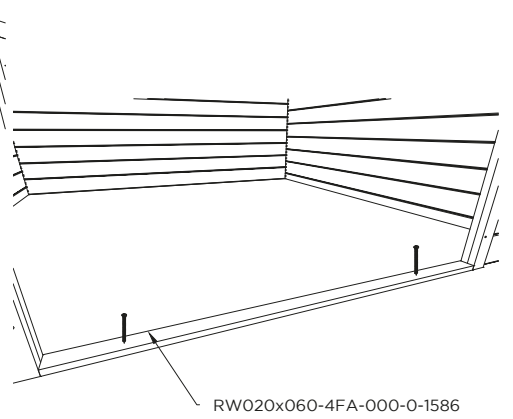

10

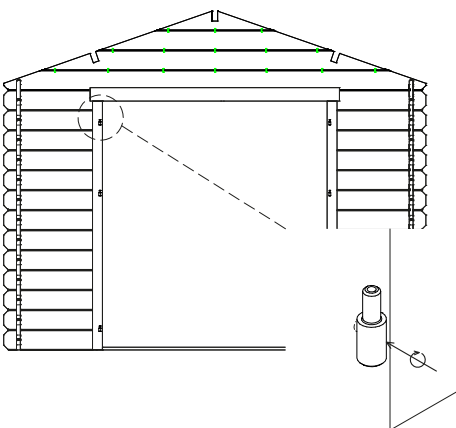

11

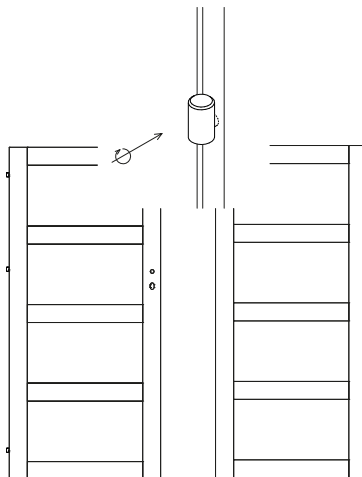

12

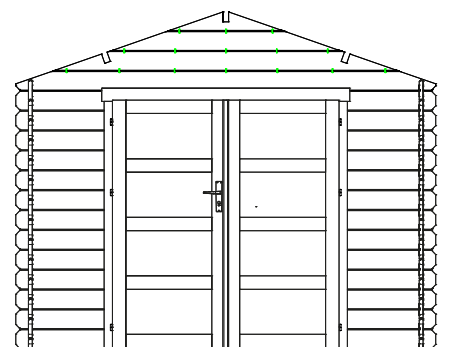

S8047C28

