

330M / 28 / 22

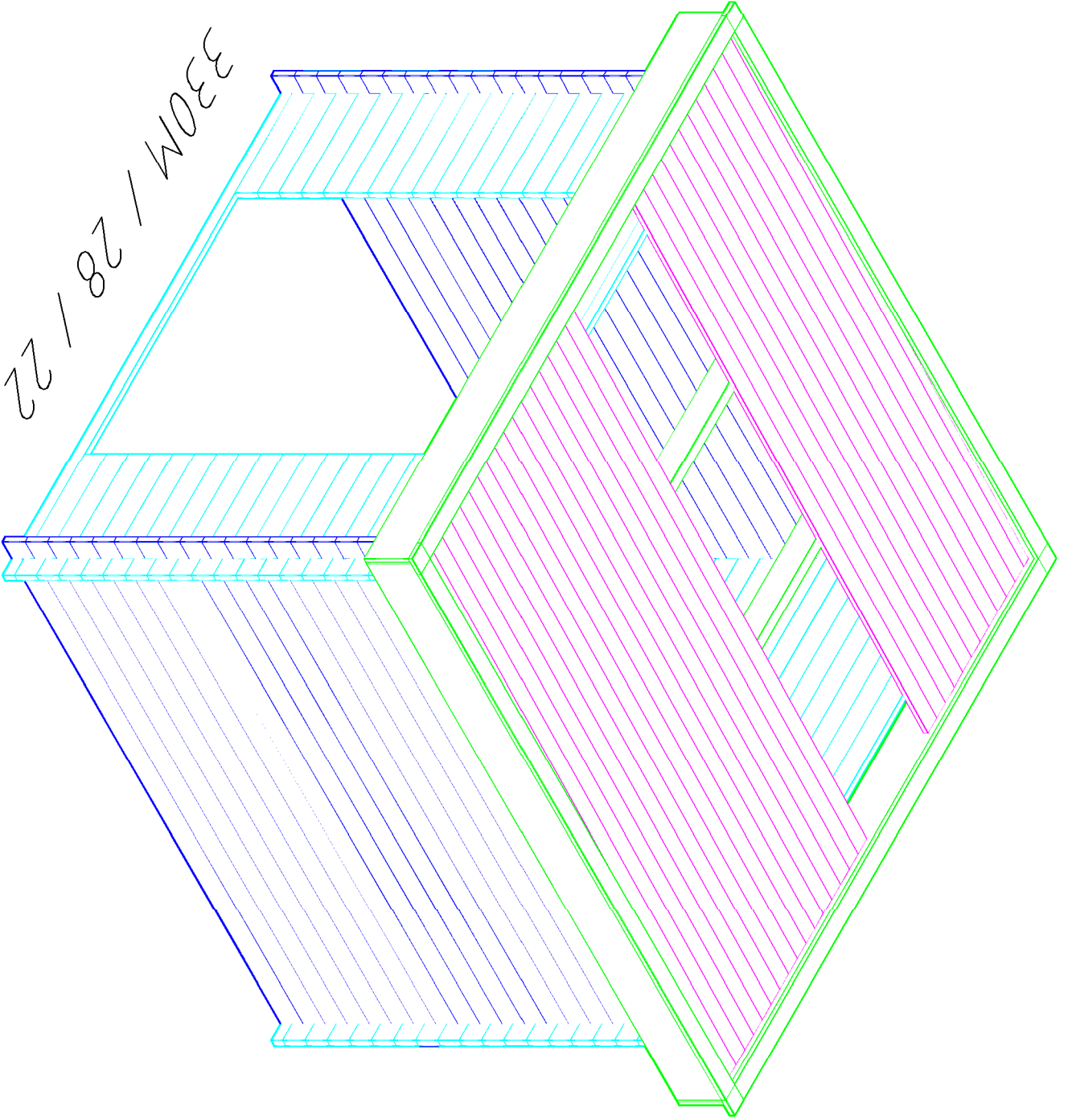

330M / 28 / 22

2800

2744

2800

2744

155x193.8

597

597

1

2

B

A

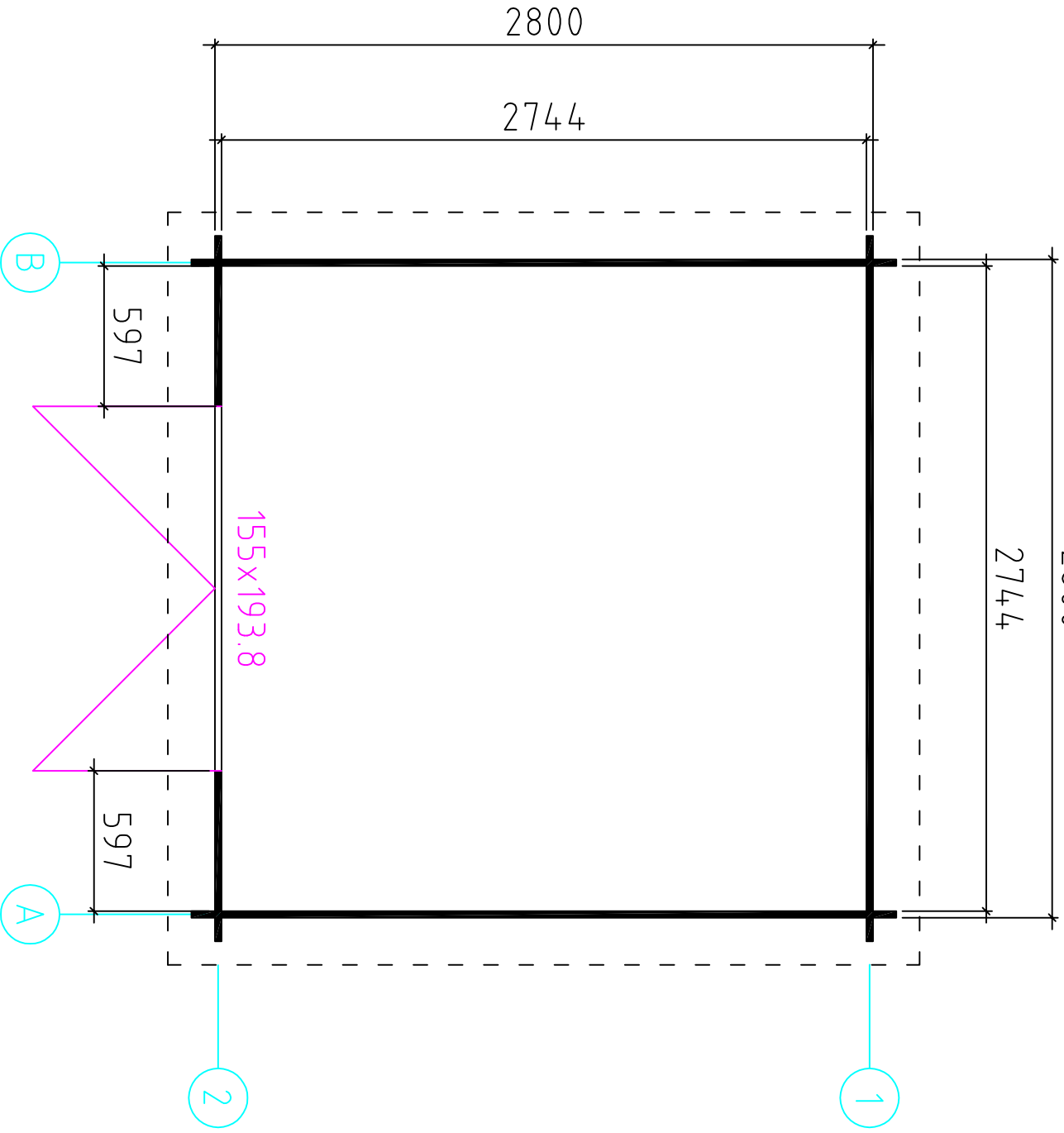

330M / 28 / 22

3318

TR1

3256

vö2

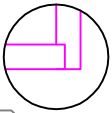

TR1

vö1

PR1

vö1

TR1

3318

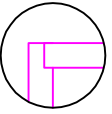

TR1

vö2



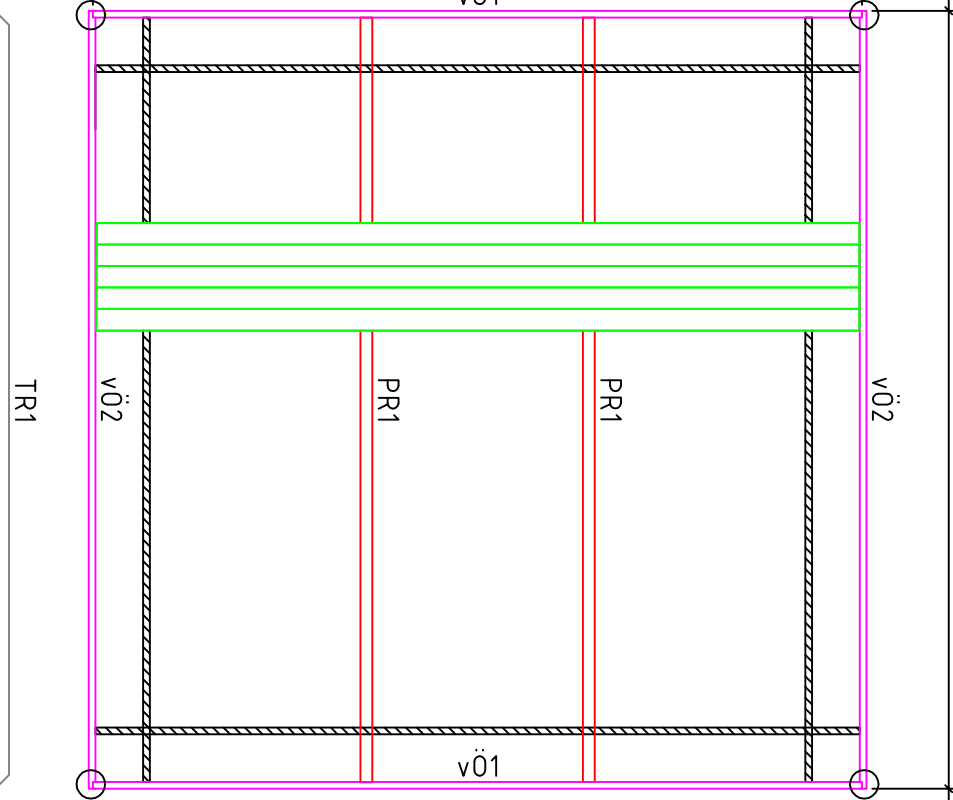

PR1

vö1

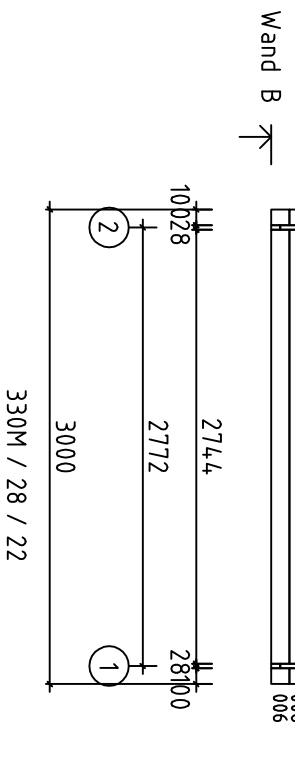
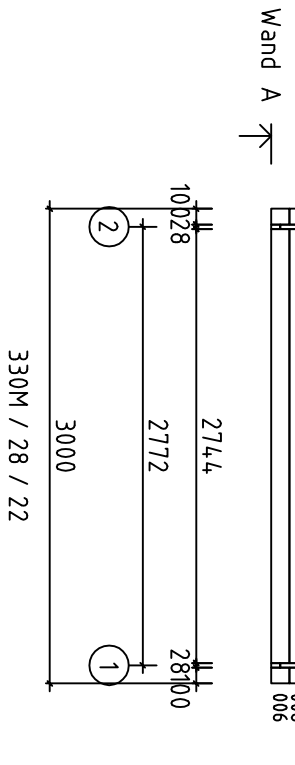
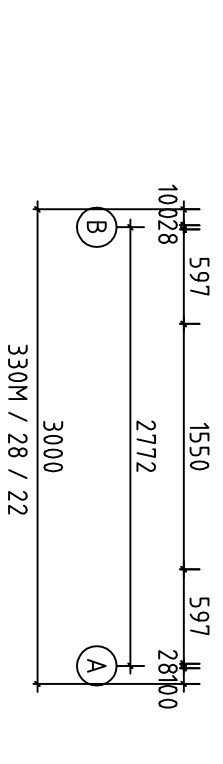
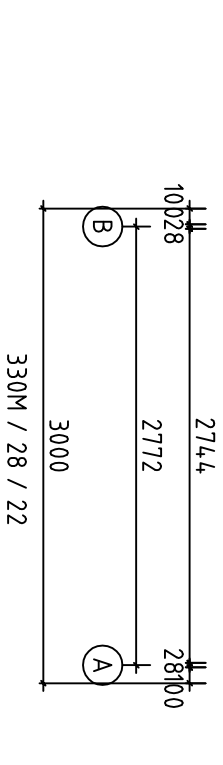
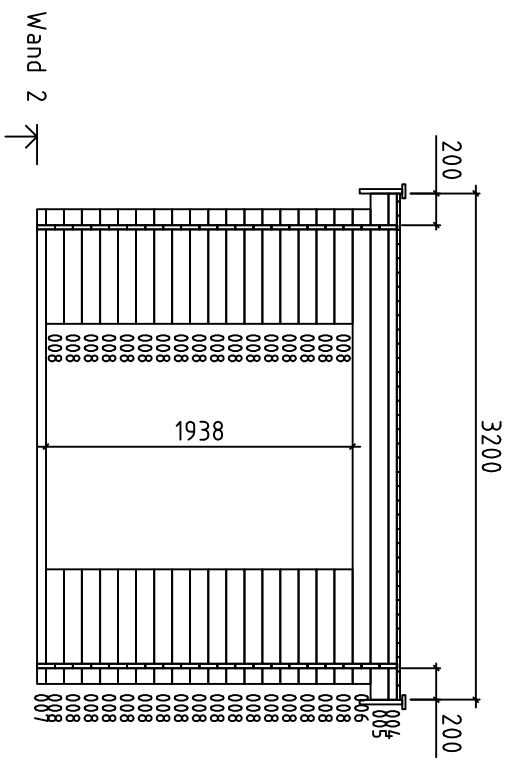
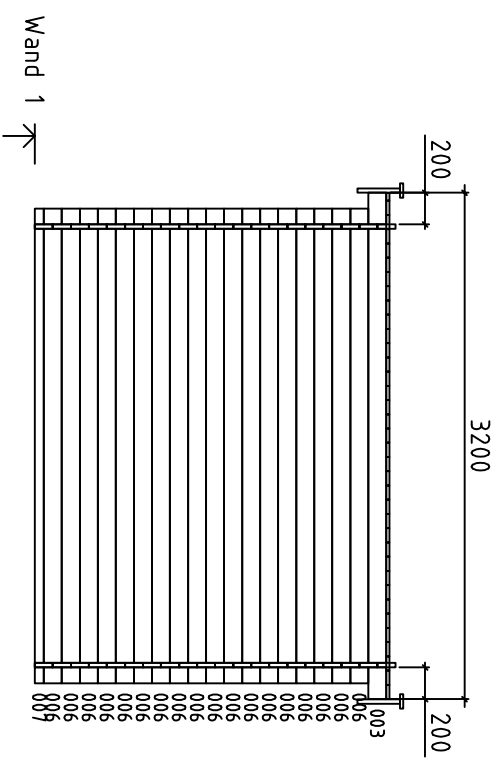

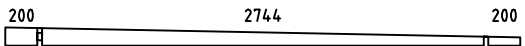
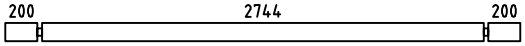
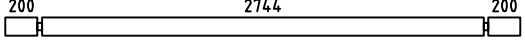
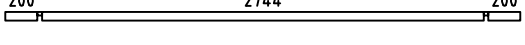
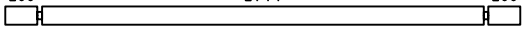
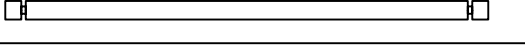
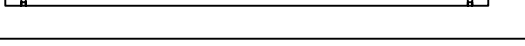
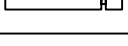
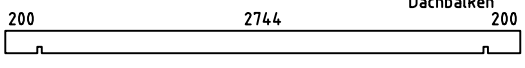
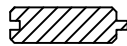
Dachbalken
Dachbretter
Elemente
Deckleiste

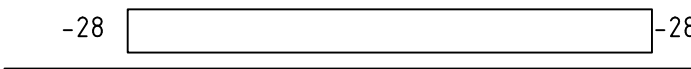
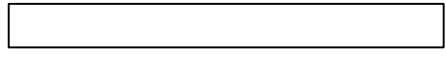

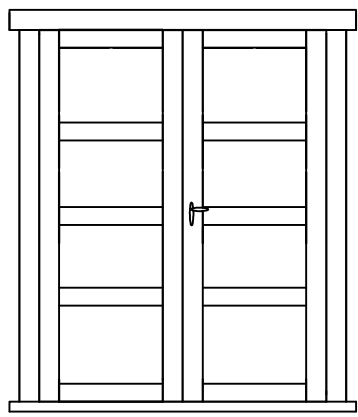
Pos	330M / 28 / 22	ST	F (mm)	L (mm)				
001		2	28x114	3200				
002		2	28x114	3200				
003		1	28x114	3200				
004		1	28x53	3200				
005		1	28x114	3200				
006		55	28x114	3000				
007		2	28x57	3000				
008		34	28x114	725				
PR1		2	50x140	3200				
010	Dachbretter 	36	90x20	3200				
011	Abdeckleiste 		20x40	14m				
vÖ2	Elemente 	2	28x270	3256				
vÖ1		2	28x270	3320				
TR1	Deckleiste 	4	90x20	3318				
U155S	<p>Tür 1550x1938 "A" uksepuudes</p>  <table border="1" data-bbox="678 1467 1085 1568"> <tr> <td>klaas</td> <td>536x337=8st..</td> </tr> <tr> <td></td> <td>kotike 1 kmpl.</td> </tr> </table>	klaas	536x337=8st..		kotike 1 kmpl.	1R		
klaas	536x337=8st..							
	kotike 1 kmpl.							