

Bemerkung: die Ansicht von Turen, Fenster und anderen Teilen kann abweichen von diesem Bild

Grundriss

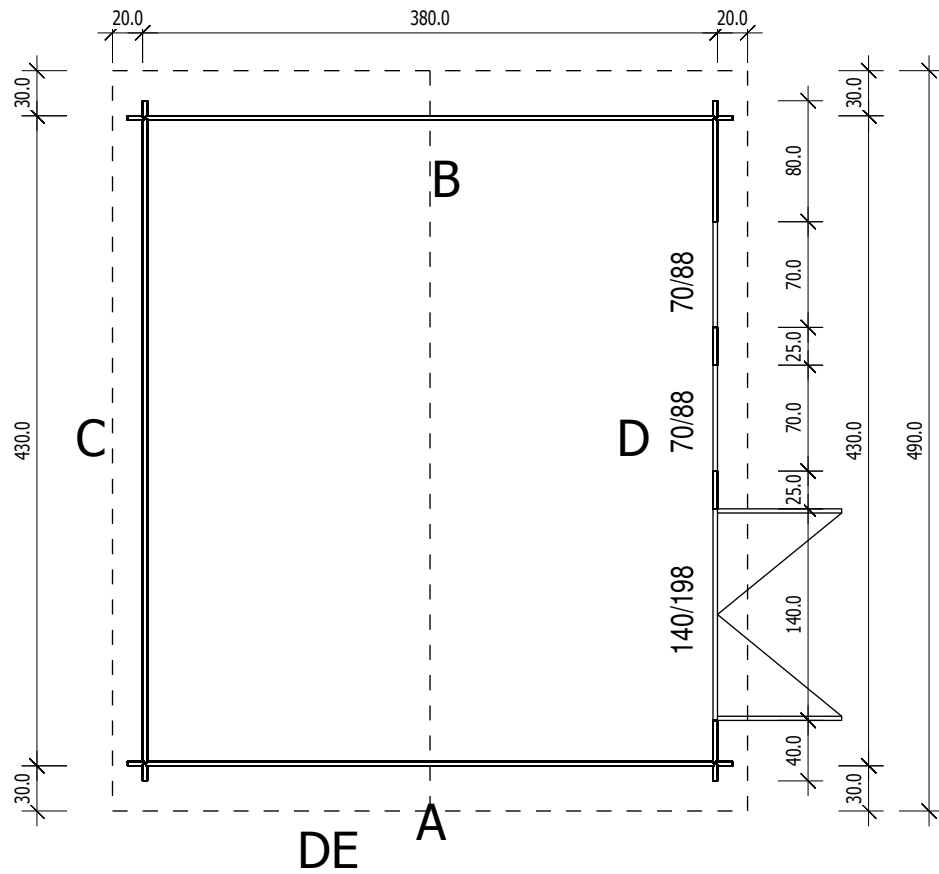

Schnitt

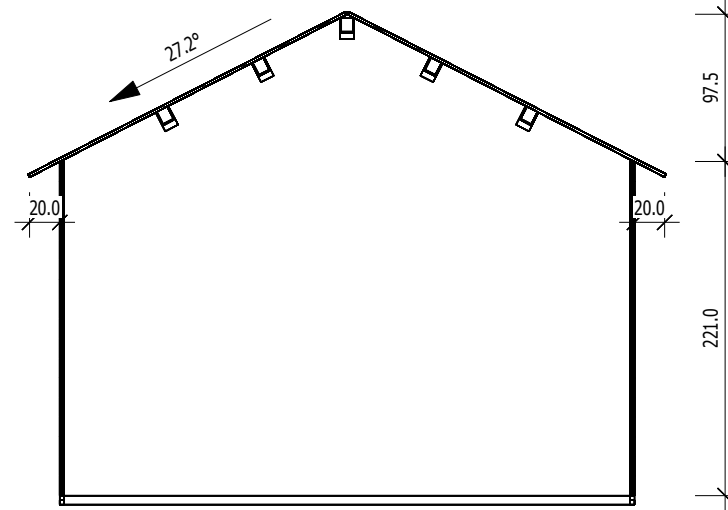

3,0

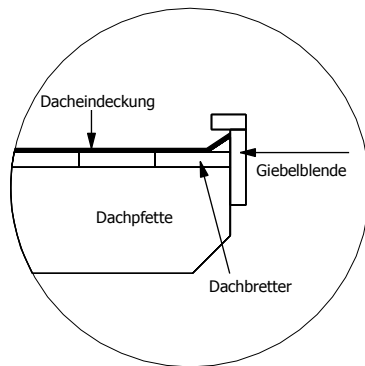

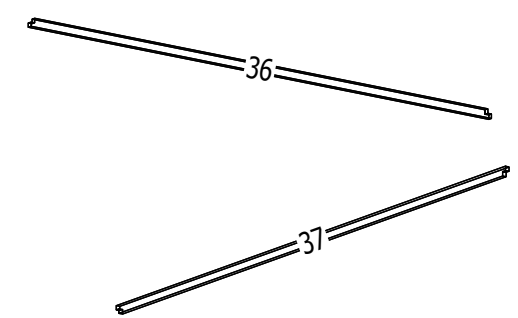
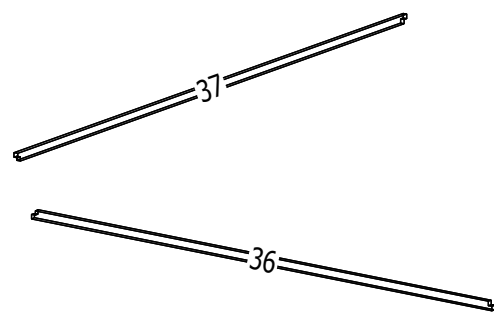
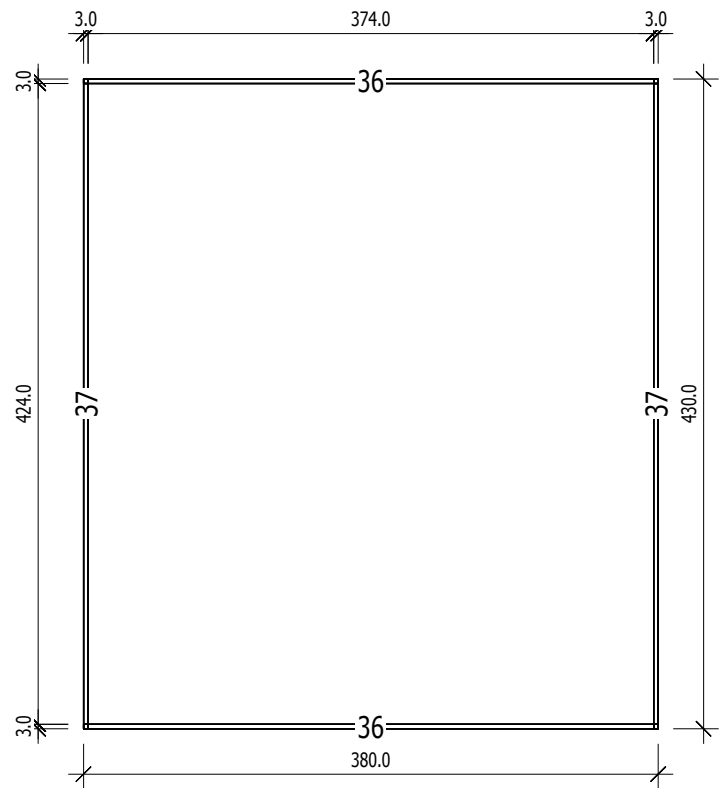

A

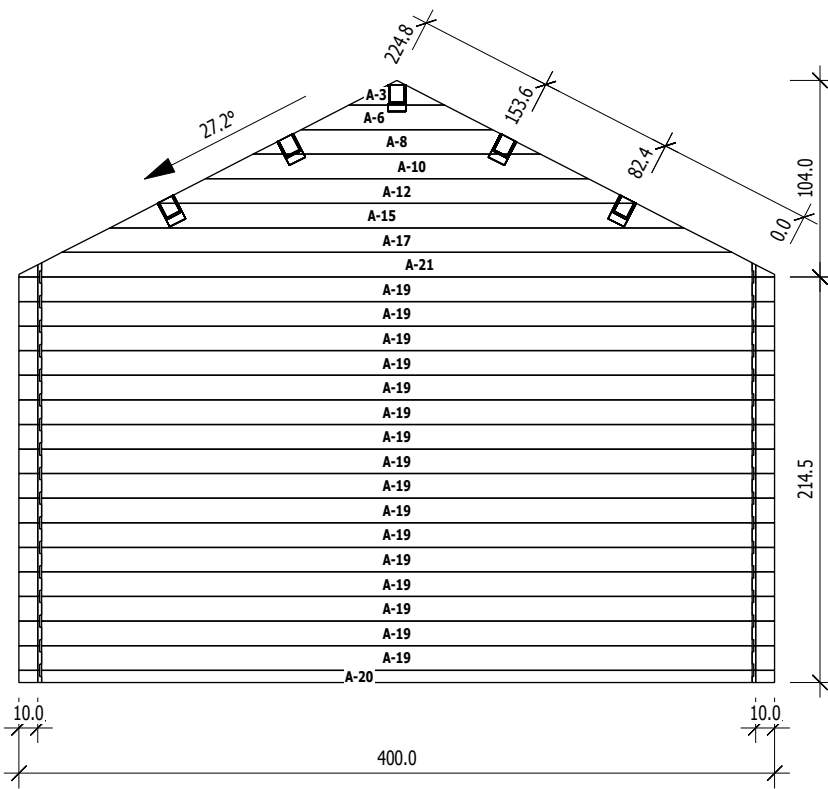

Nr	H	L	Psc
A 3	13.0	50.7	1
A 6	13.0	101.3	1
A 8	13.0	152.0	1
A 10	13.0	202.7	1
A 12	13.0	253.3	1
A 15	13.0	304.0	1
A 17	13.0	354.7	1
A 19	13.0	400.0	16
A 20	6.5	400.0	1
A 21	13.0	400.0	1

B

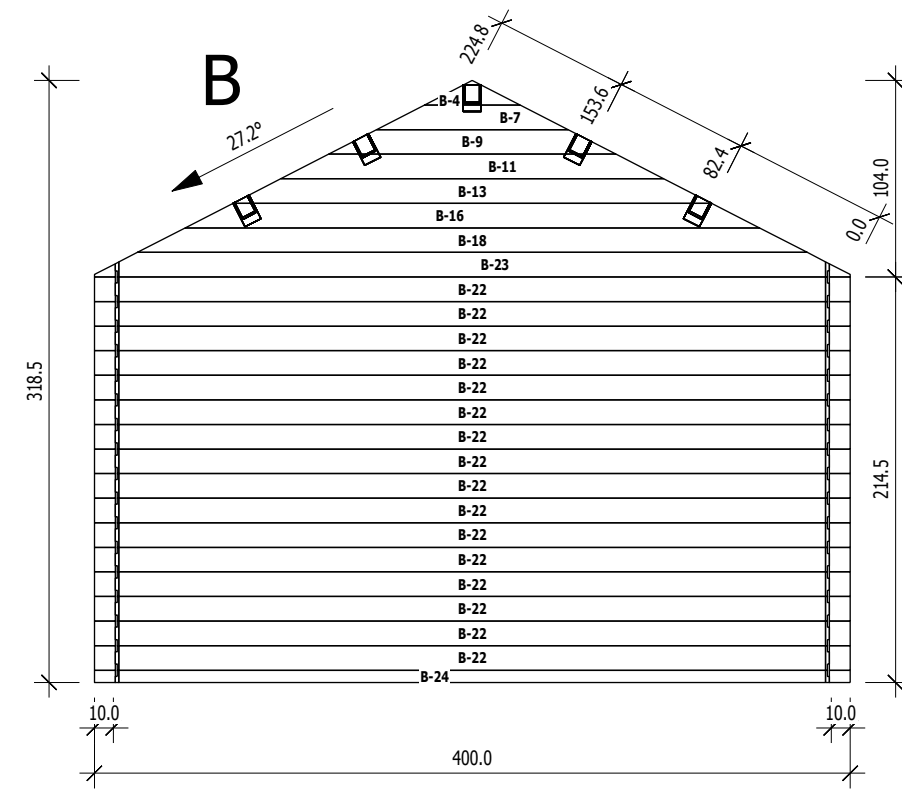

Nr	H	L	Psc
B 4	13.0	50.7	1
B 7	13.0	101.3	1
B 9	13.0	152.0	1
B 11	13.0	202.7	1
B 13	13.0	253.3	1
B 16	13.0	304.0	1
B 18	13.0	354.7	1
B 21	13.0	400.0	16
B 22	13.0	400.0	1
B 23	13.0	400.0	1
B 24	6.5	400.0	1

C

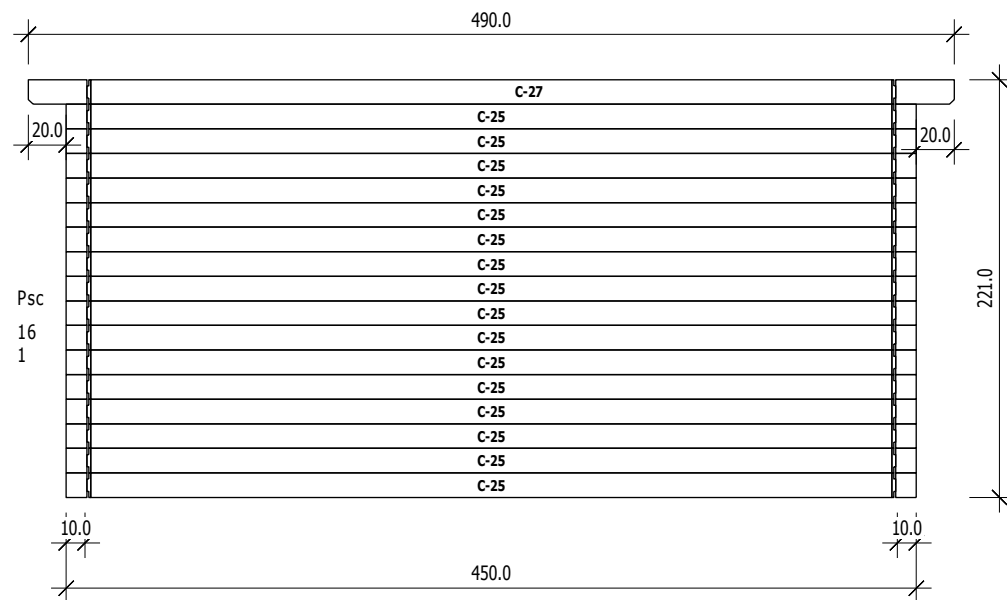

Nr	H	L	Psc
C 25	13.0	450.0	16
C 27	13.0	490.0	1

D

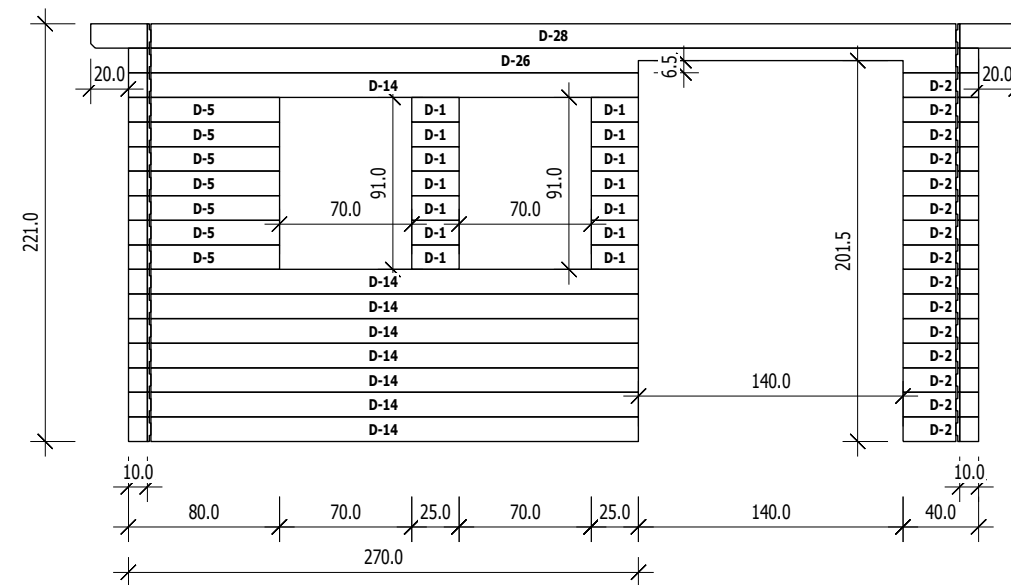

Nr	H	L	Psc
D 1	13.0	25.0	14
D 2	13.0	40.0	15
D 5	13.0	80.0	7
D 14	13.0	270.0	8
D 26	13.0	450.0	1
D 28	13.0	490.0	1

