

3,0

NL-210603/BE10079083



Bemerkung: die Ansicht von Turen, Fenster und anderen Teilen kann abweichen von diesem Bild

3,0

Grundriss

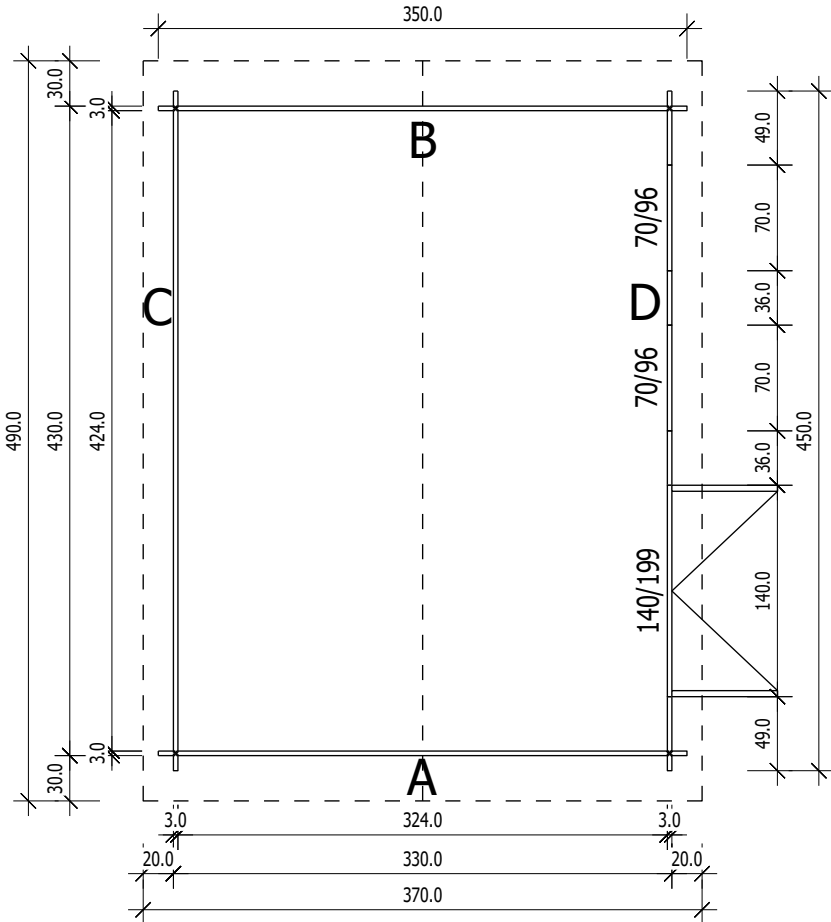

Schnitt

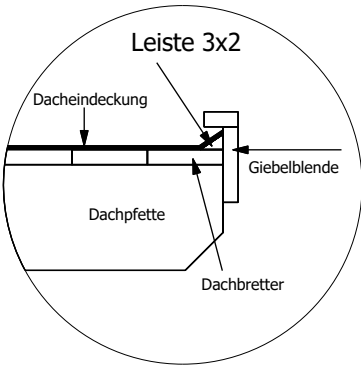
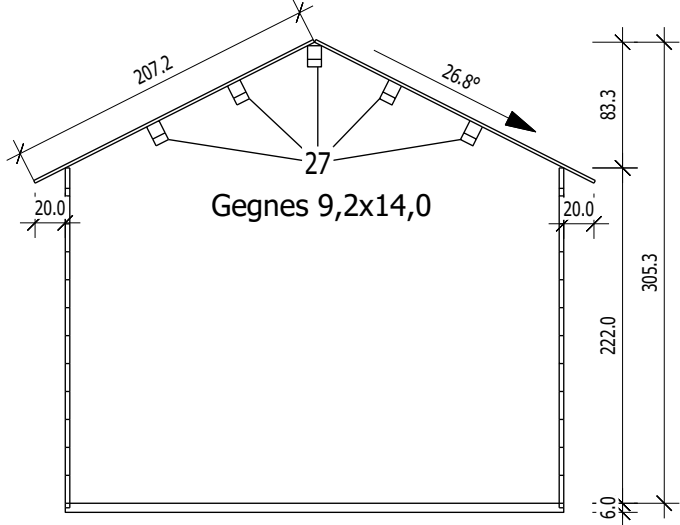

Projektas Uzsakymo Nr.	Brezinys Planas, Pjuvis	Mastelis 1 : 50
NL-210603		Data 2021/07/07
		Projektavo S. Lietuvinkaite

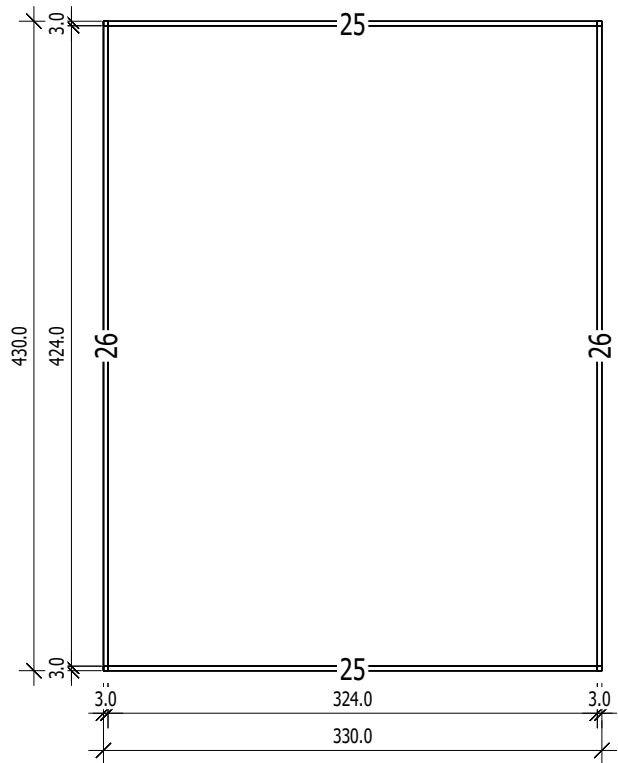

Grundrahmenplan

Nr.	B	H	L	Psc
	cm	cm	cm	
25	3,0	6,0	330,0	2
26	3,0	6,0	430,0	2

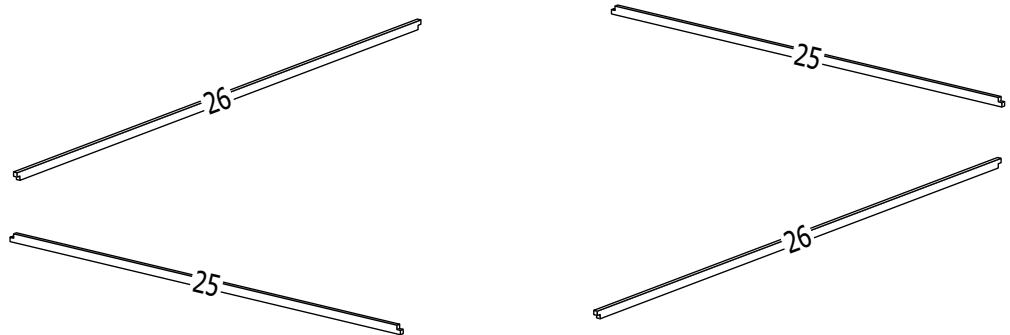

Projektas Uzsakymo Nr.	Brezinys Pagrindas	Mastelis 1 : 50
NL-210603		Data 2021/07/07
		Projektavo S. Lietuvininkaitė

3,0

A
M 1:40

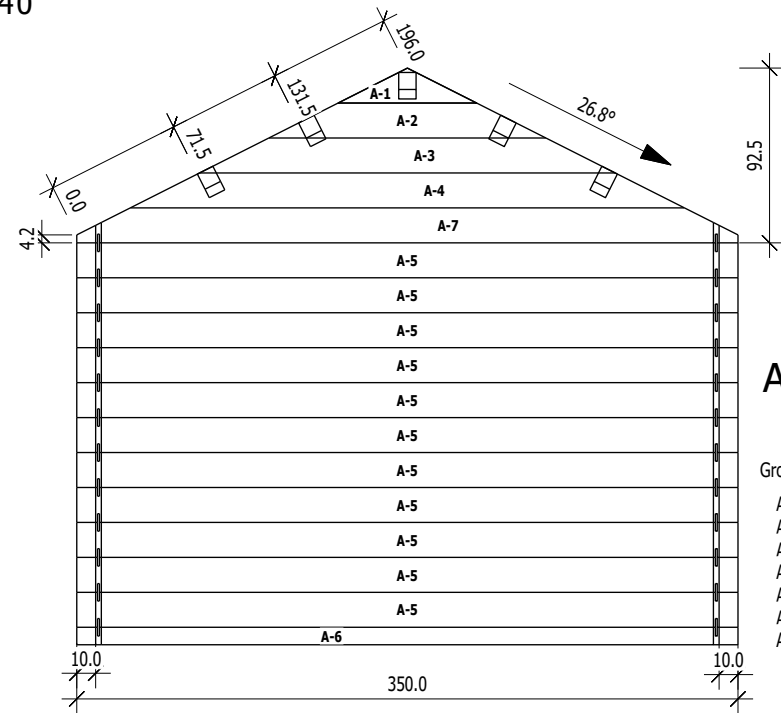

Ansicht von Aussen
Gegnes 9,2x14,0

Group	Nr	H	L	Psc
A	1	18.5	73.3	1
A	2	18.5	146.7	1
A	3	18.5	220.0	1
A	4	18.5	293.3	1
A	5	18.5	350.0	11
A	6	9.3	350.0	1
A	7	18.5	350.0	1

B
M 1:40

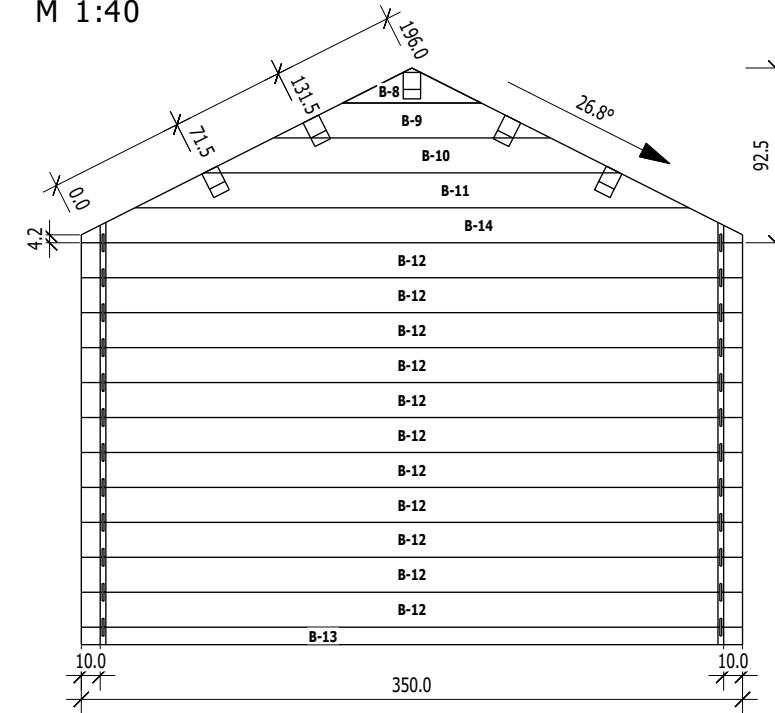

Ansicht von Innen
Gegnes 9,2x14,0

Group	Nr	H	L	Psc
B	8	18.5	73.3	1
B	9	18.5	146.7	1
B	10	18.5	220.0	1
B	11	18.5	293.3	1
B	12	18.5	350.0	11
B	13	9.3	350.0	1
B	14	18.5	350.0	1

C
M 1:40

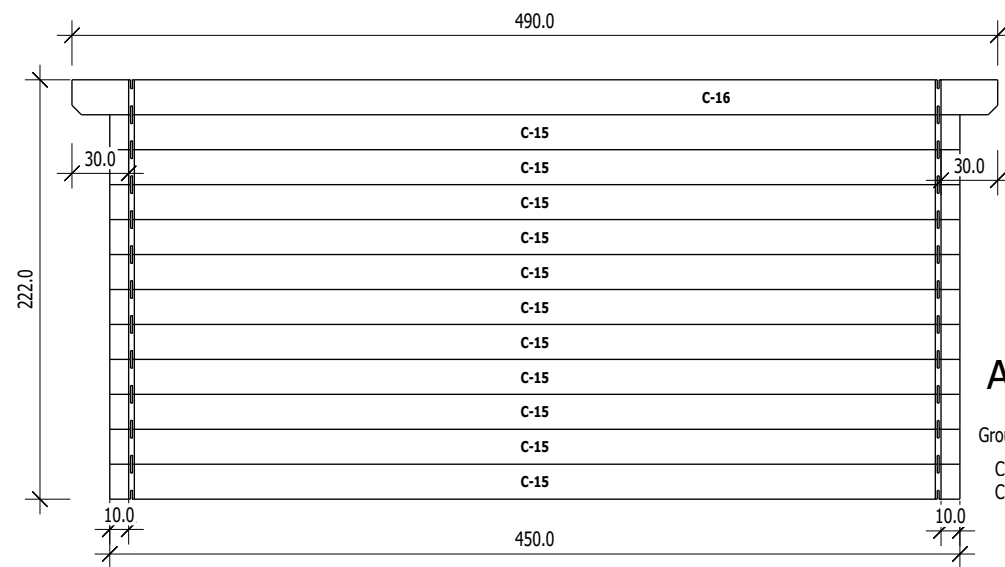

Ansicht von Aussen

Group	Nr	H	L	Psc
C	15	18.5	450.0	11
C	16	18.5	490.0	1

D
M 1:40

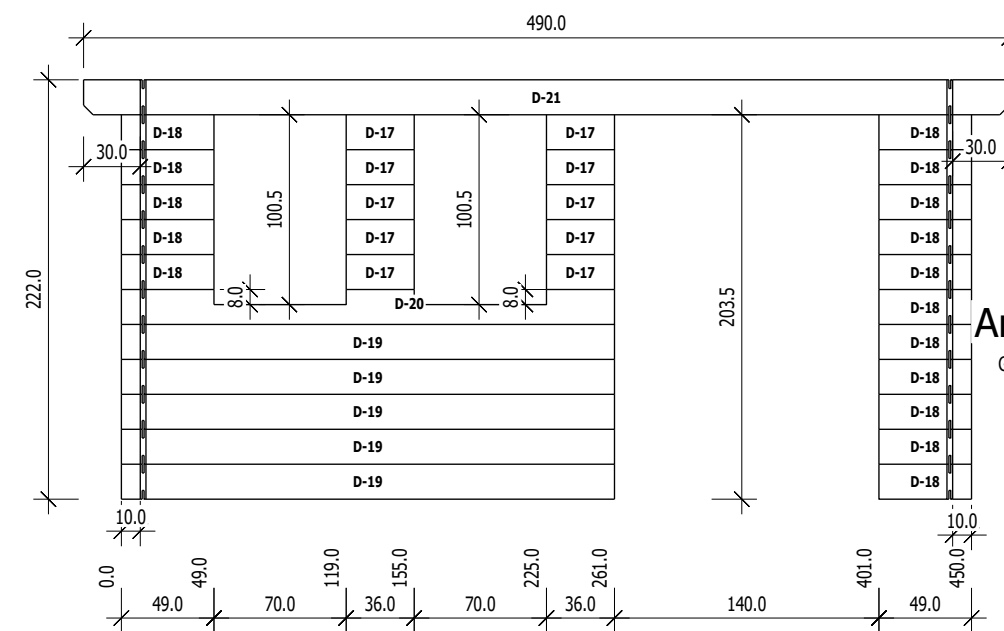

Ansicht von Innen

Group	Nr	H	L	Psc
D	17	18.5	36.0	10
D	18	18.5	49.0	16
D	19	18.5	261.0	5
D	20	18.5	261.0	1
D	21	18.5	490.0	1

Atliko:	S. Lietuvininkaite	Data	Projekto. Nr.: NL-210603	Namelio modelis:
			Grupe(siena): A;B;C;D	
			Sienos storis: 3.0cm	