

Lumen 186 x 203

Bemerkung: die Ansicht von Turen, Fenster und anderen Teilen kann abweichen von diesem Bild

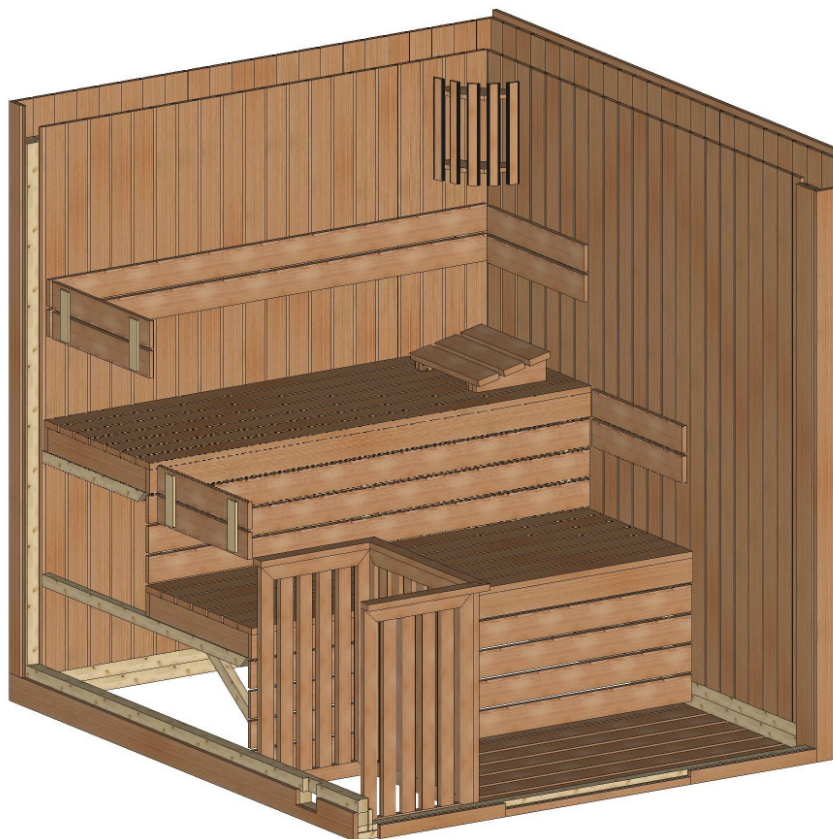

Schnitt

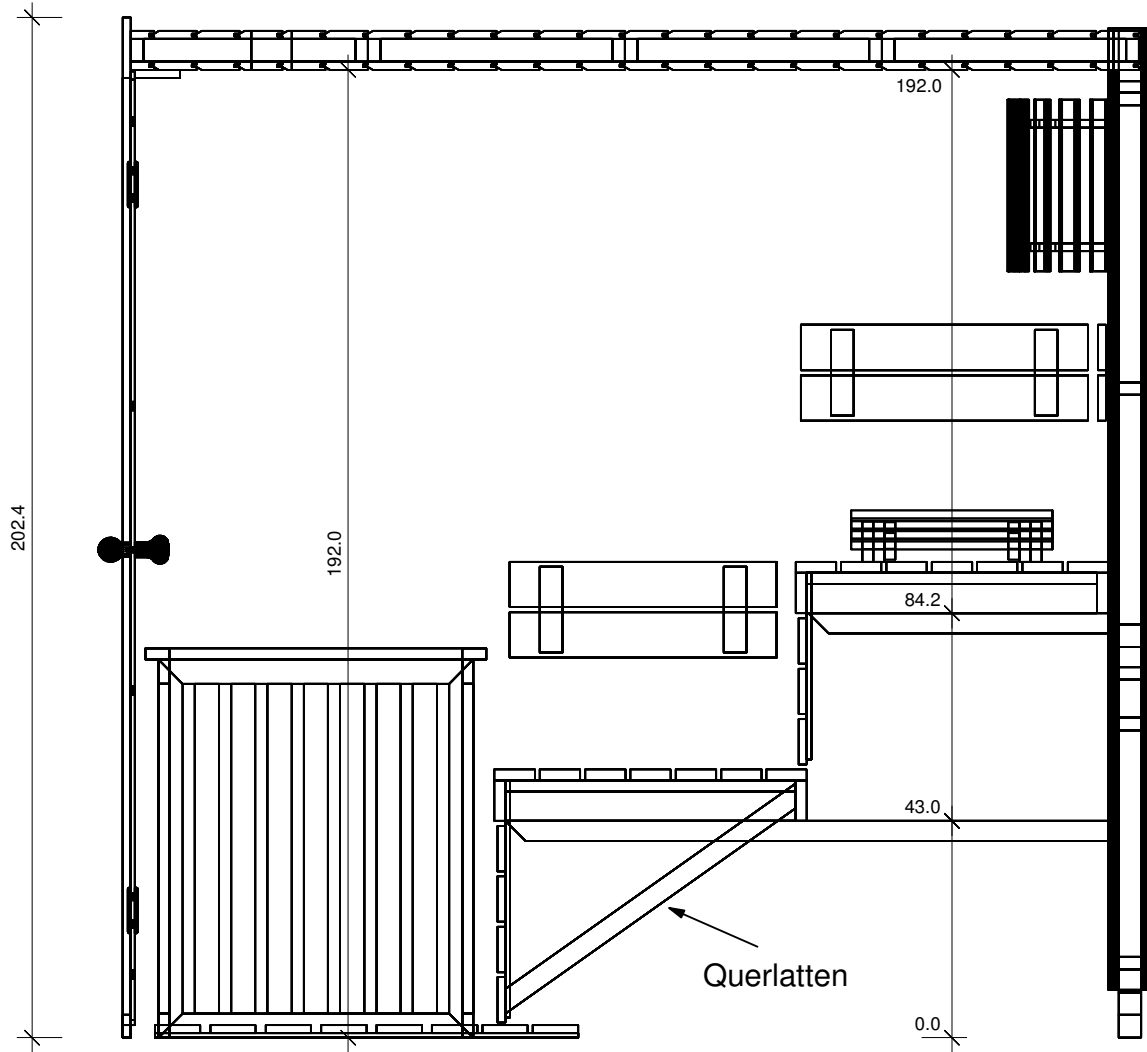

Grundriss

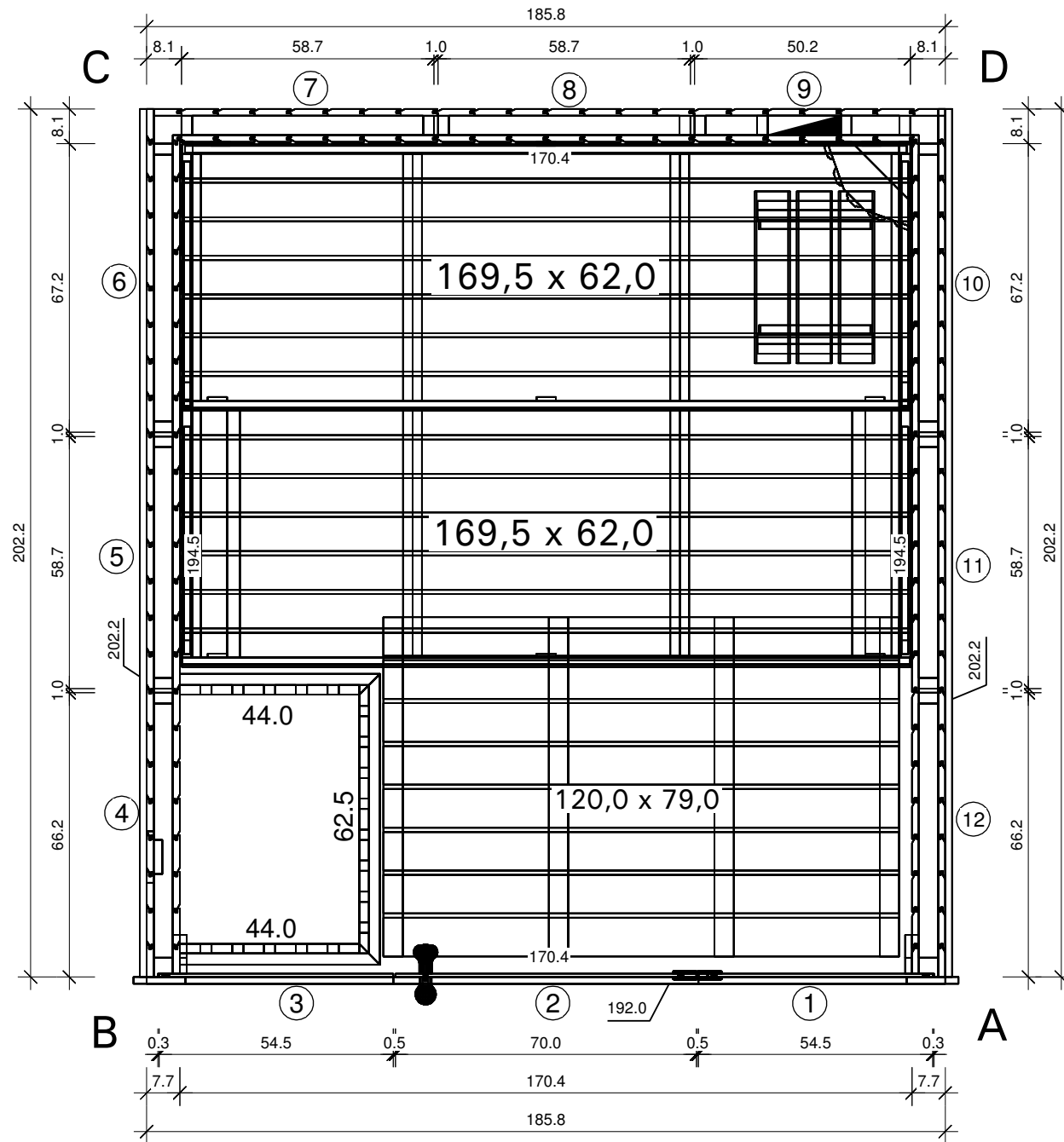

Grundrahmenplan

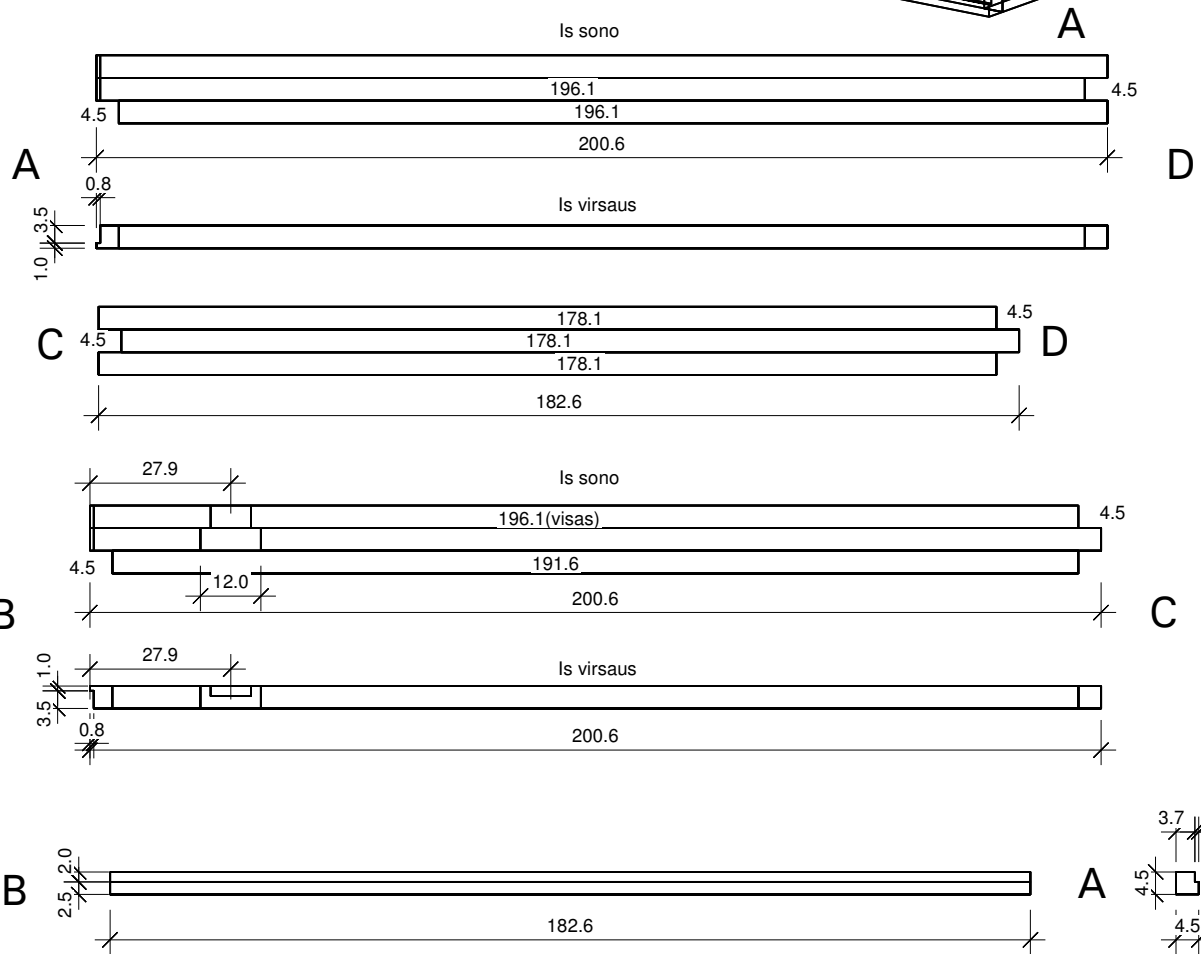
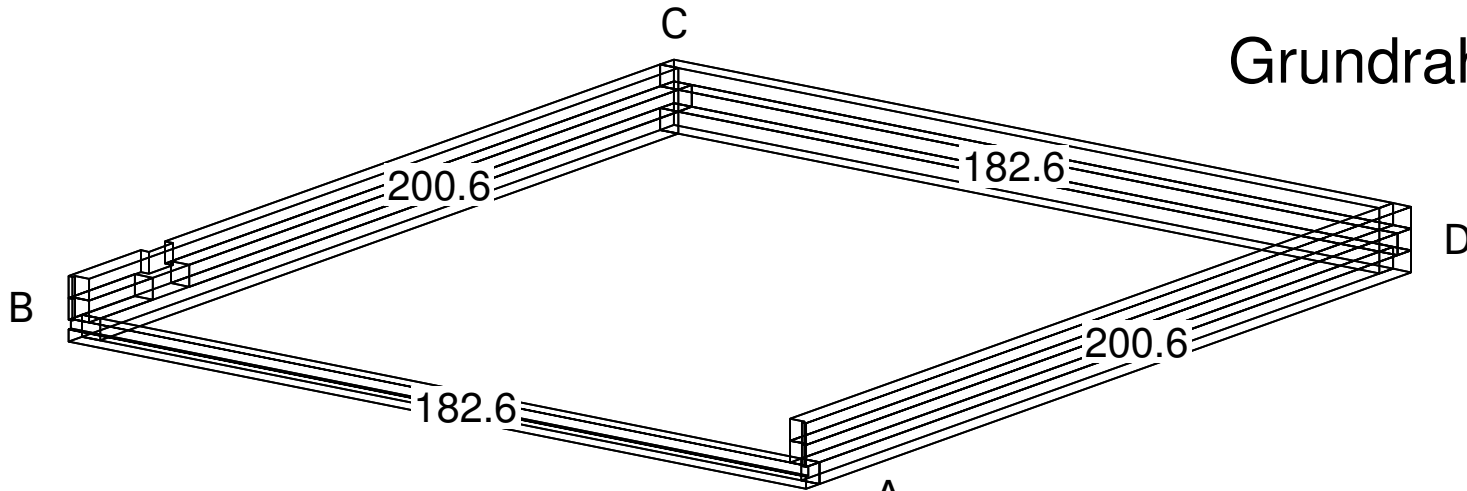

Dachrahmen

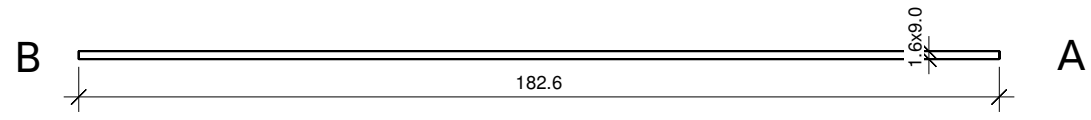
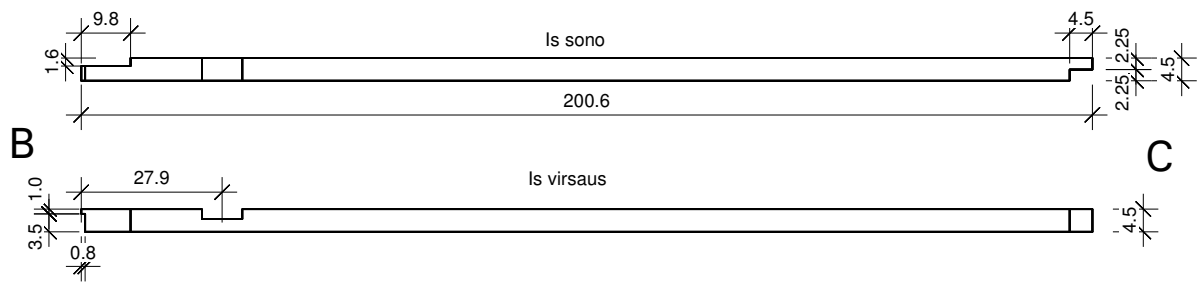
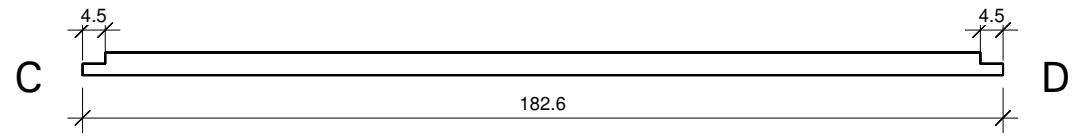
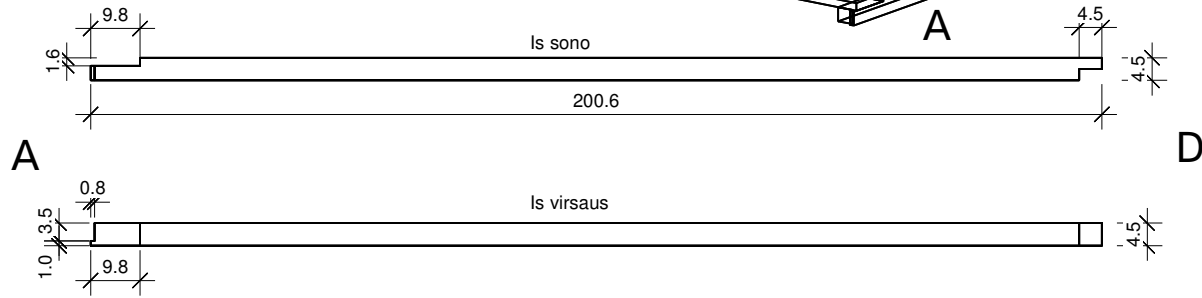
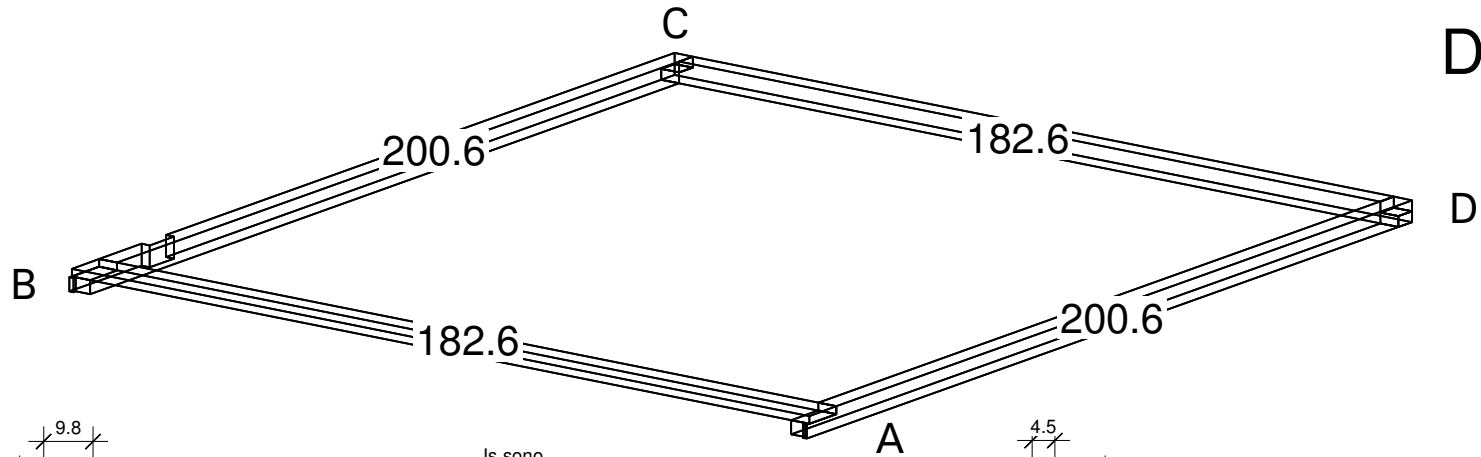

Dachelemente

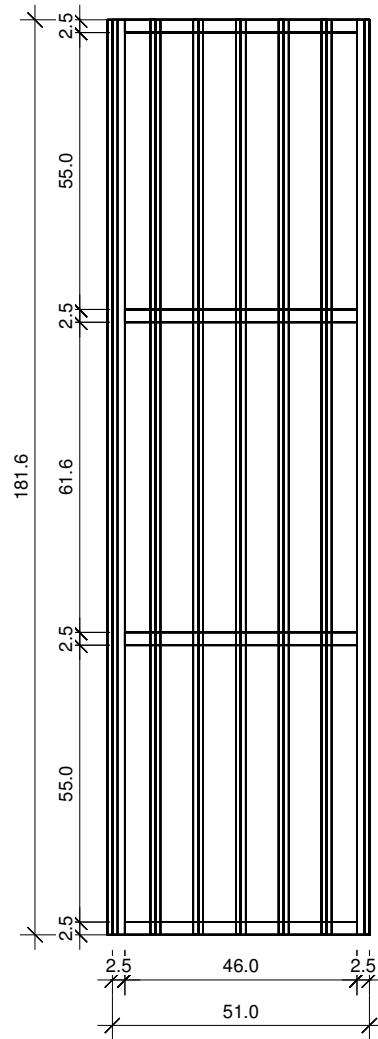
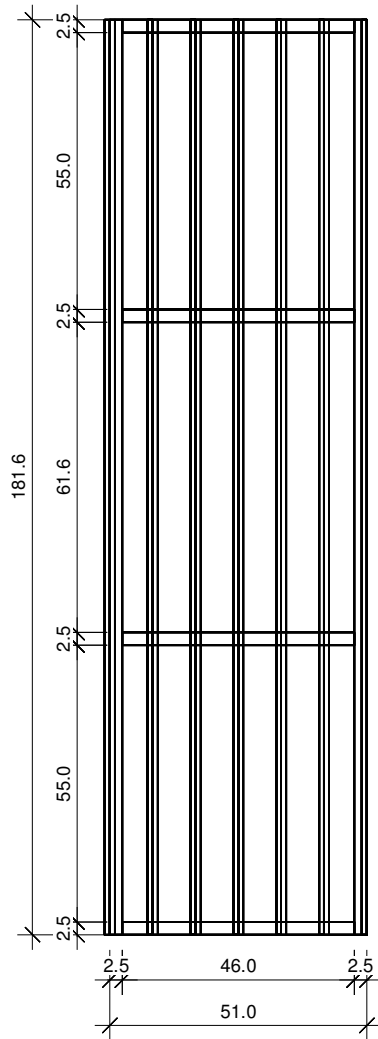
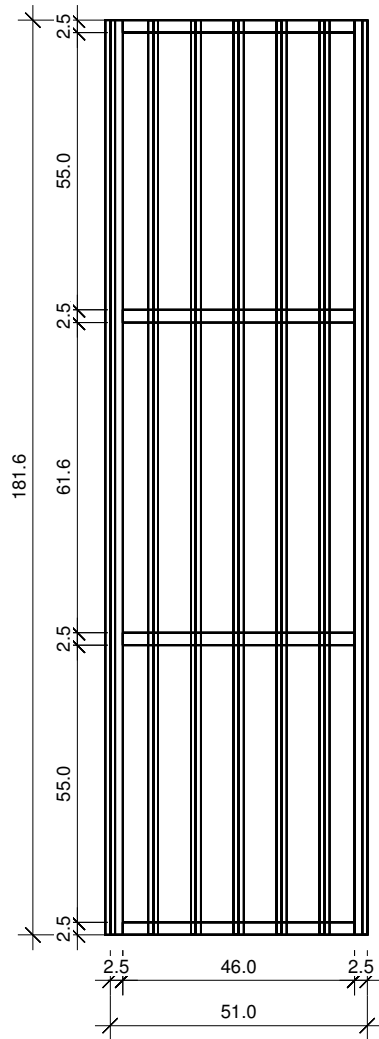
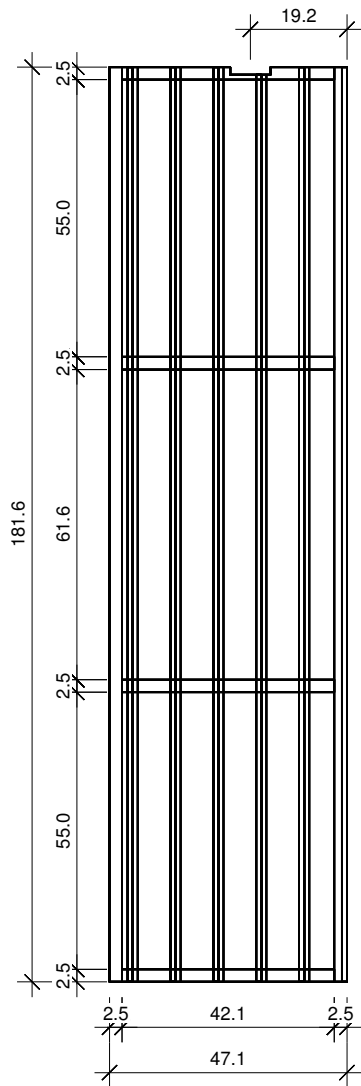
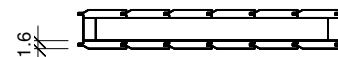
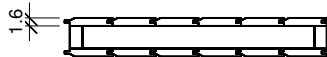
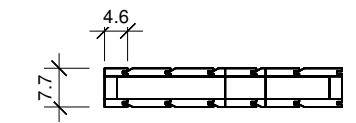

Glaswand

