

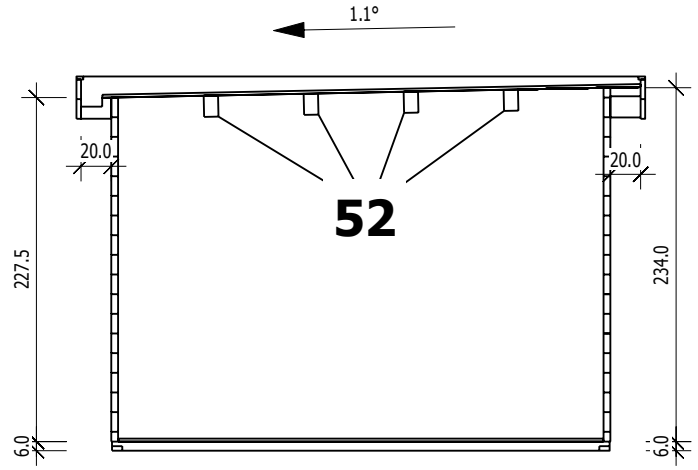

Bemerkung: die Ansicht von Turen, Fenster und anderen Teilen kann abweichen von diesem Bild

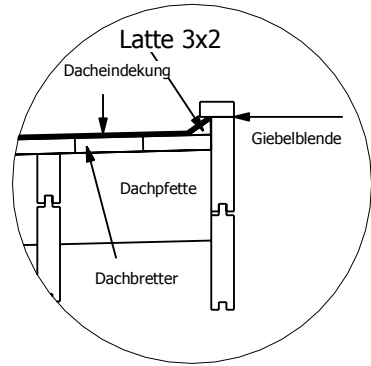

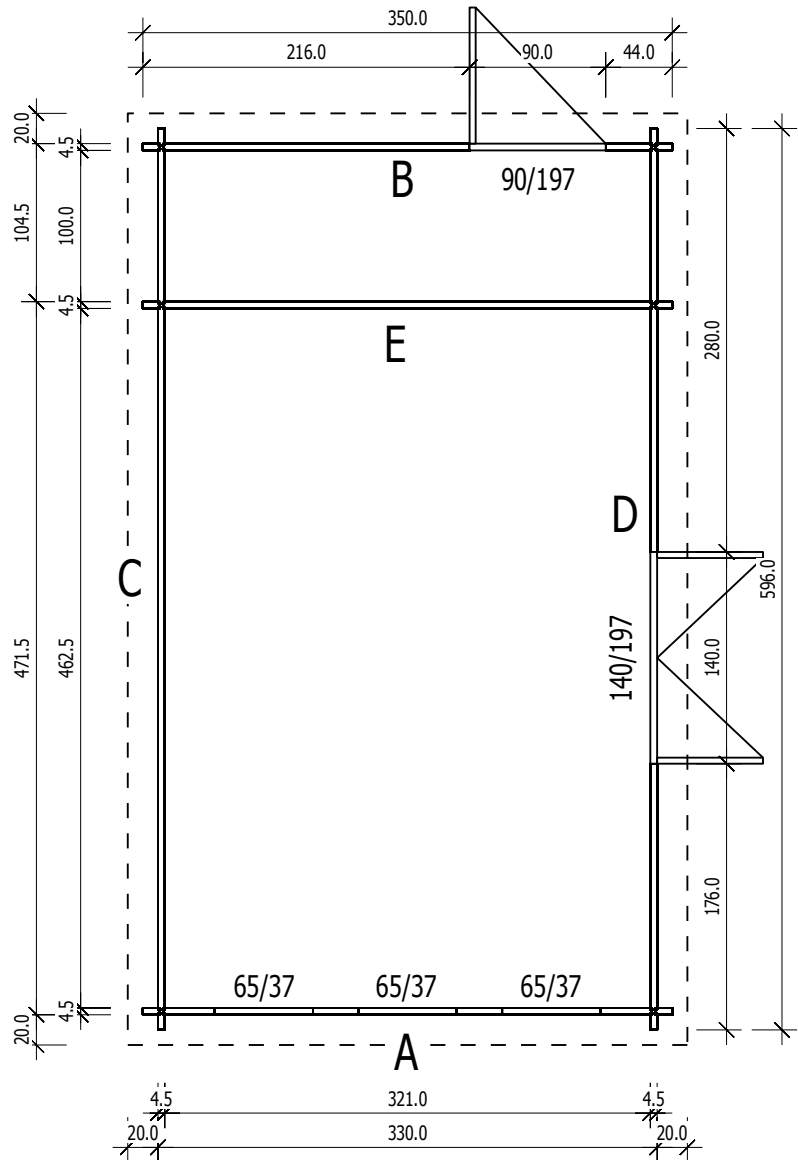

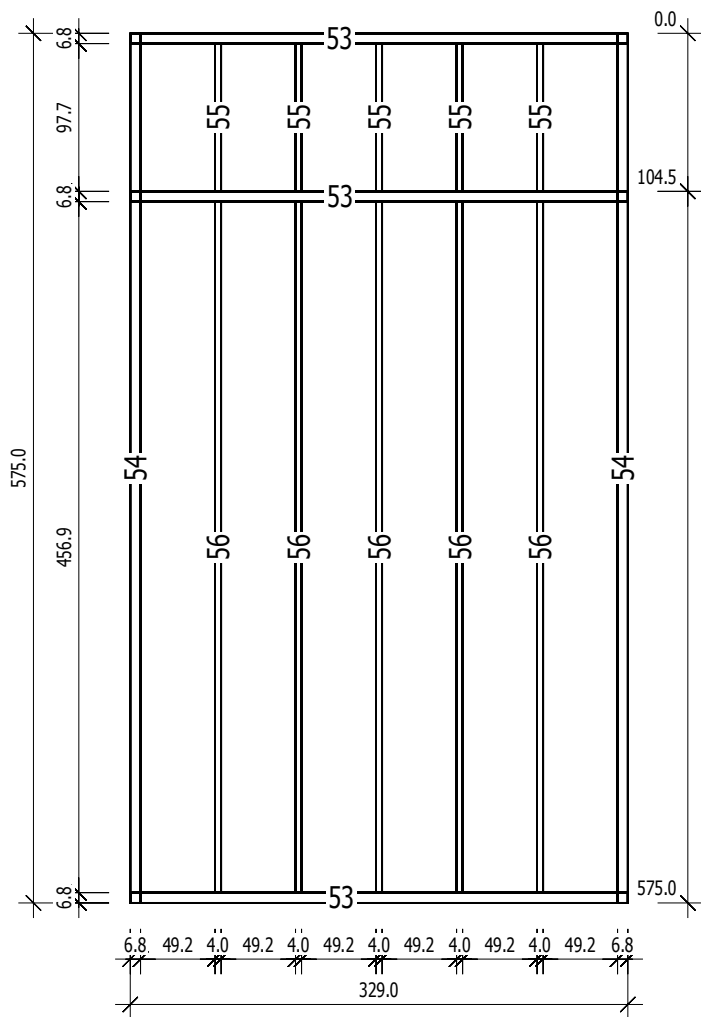

Nr	B [cm]	H [cm]	L [cm]	Psc
53	6,8	6,0	329,0	3
54	6,8	6,0	575,0	2
55	4,0	6,0	97,7	5
56	4,0	6,0	456,9	5

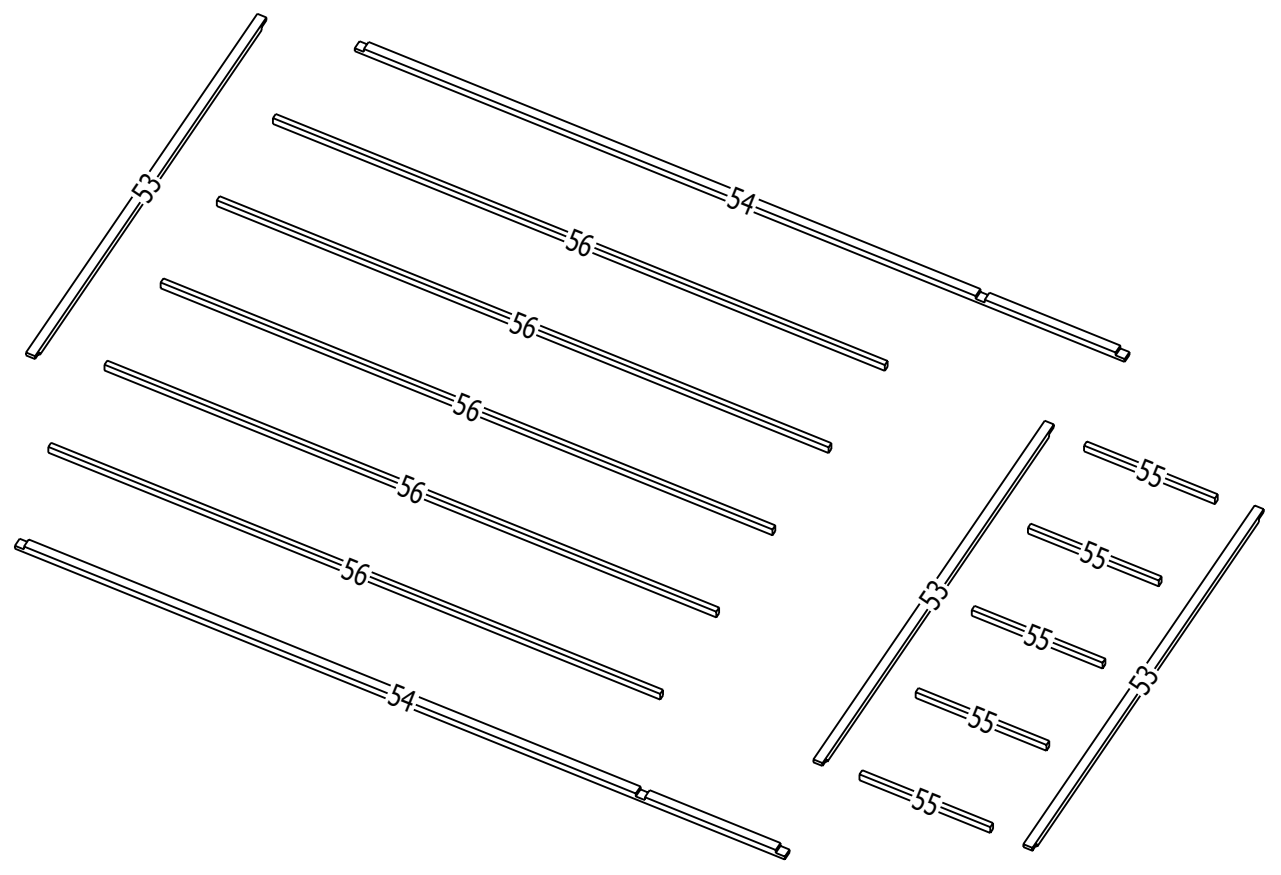

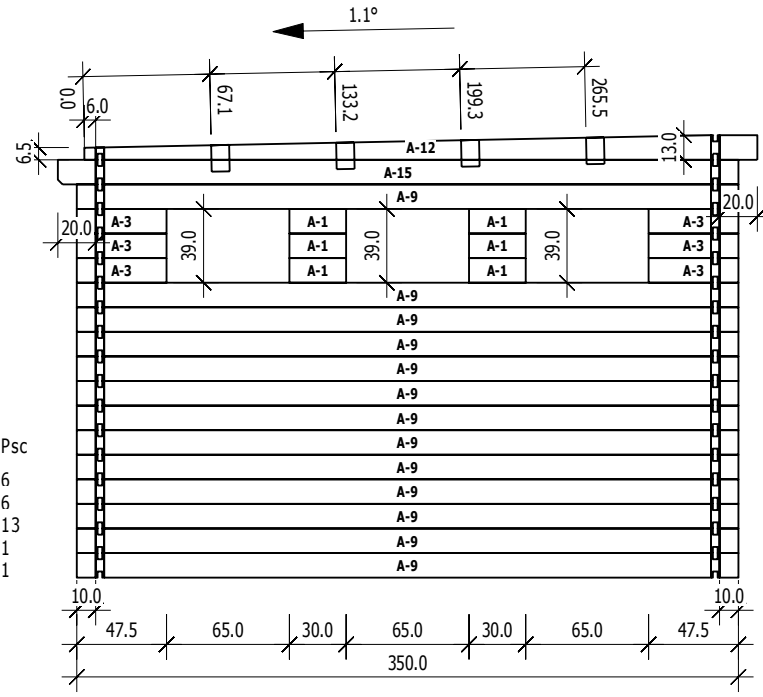

Nr	H	L	Psc
A 1	13.0	30.0	6
A 3	13.0	47.5	6
A 9	13.0	350.0	13
A 12	13.0	356.0	1
A 15	13.0	360.0	1

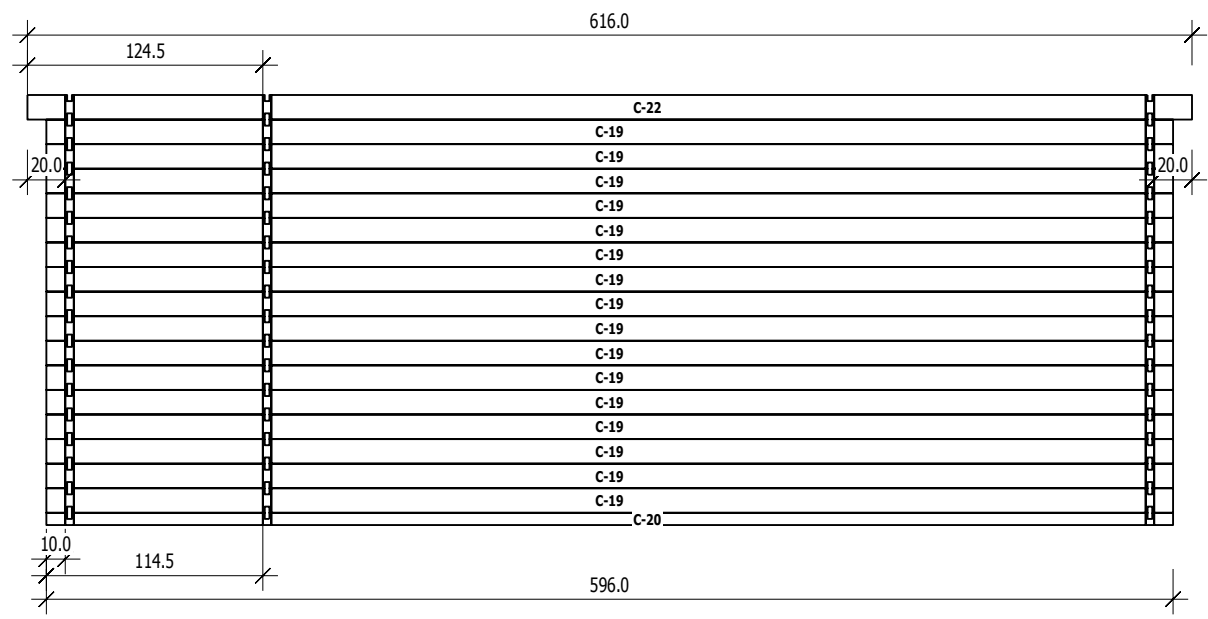

Nr	H	L	Psc
C 19	13.0	596.0	16
C 20	6.5	596.0	1
C 22	13.0	616.0	1

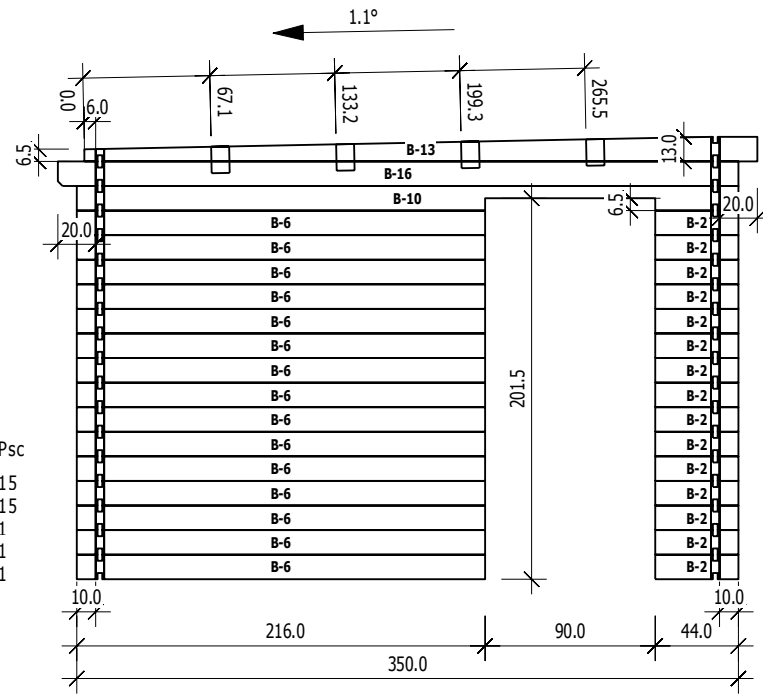

Nr	H	L	Psc
B 2	13.0	44.0	15
B 6	13.0	216.0	15
B 10	13.0	350.0	1
B 13	13.0	356.0	1
B 16	13.0	360.0	1

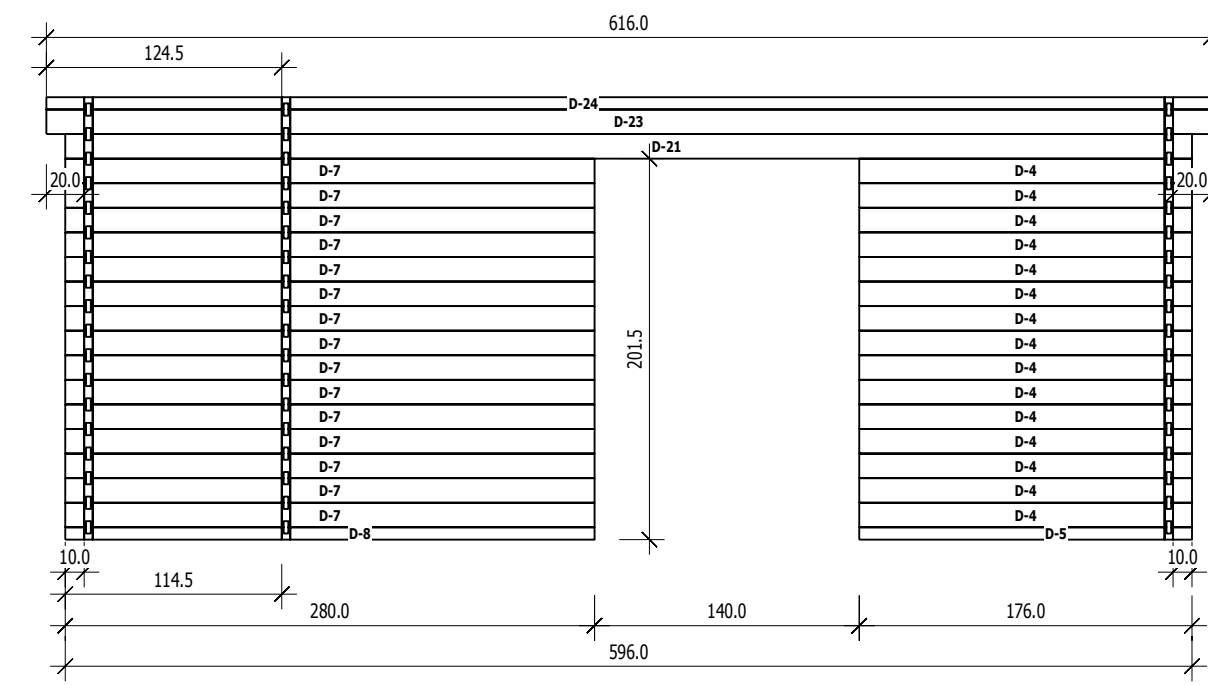

Nr	H	L	Psc
D 4	13.0	176.0	15
D 5	6.5	176.0	1
D 7	13.0	280.0	15
D 8	6.5	280.0	1
D 21	13.0	596.0	1
D 23	13.0	616.0	1
D 24	6.5	616.0	1

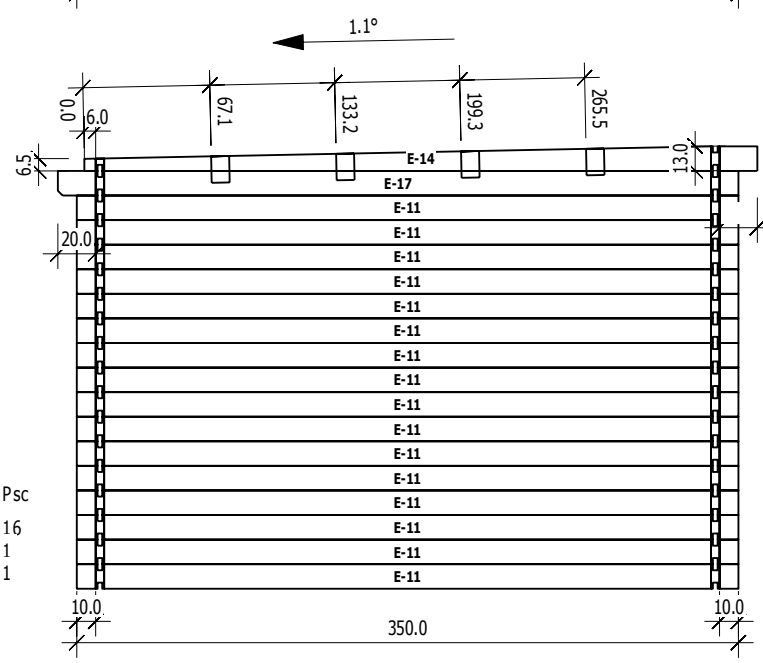

Nr	H	L	Psc
E 11	13.0	350.0	16
E 14	13.0	356.0	1
E 17	13.0	360.0	1