

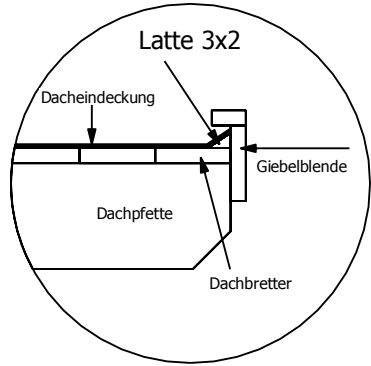

Bemerkung: die Ansicht von Turen, Fenster und anderen Teilen kann abweichen von diesem Bild

Grundriss

4,5

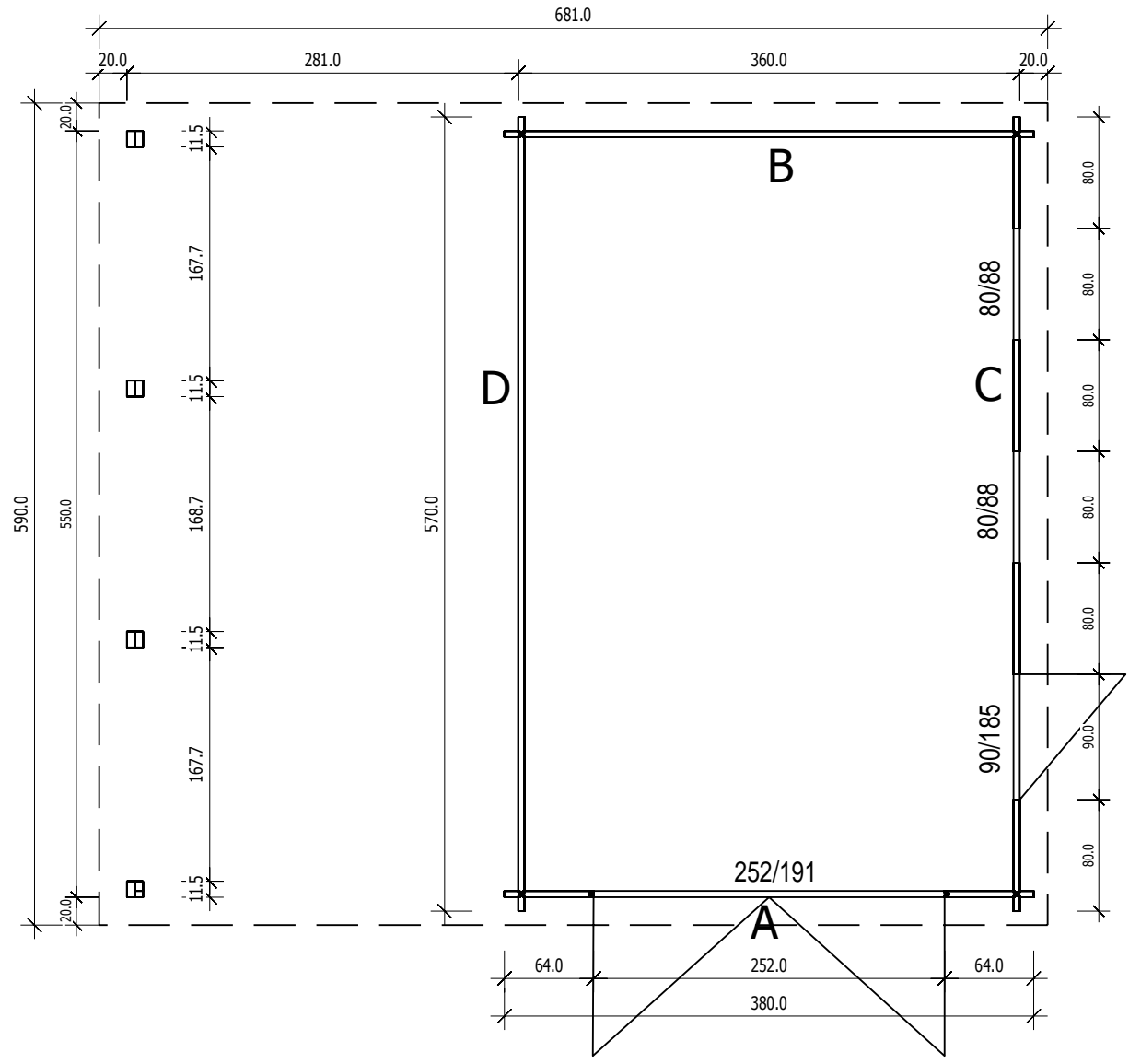

Schnitt

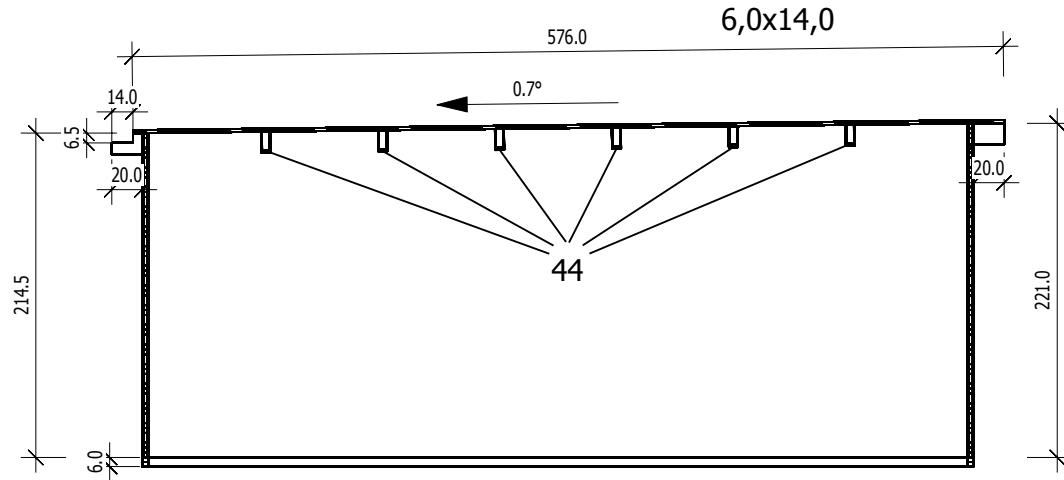

4,5

Grundrahmenplan

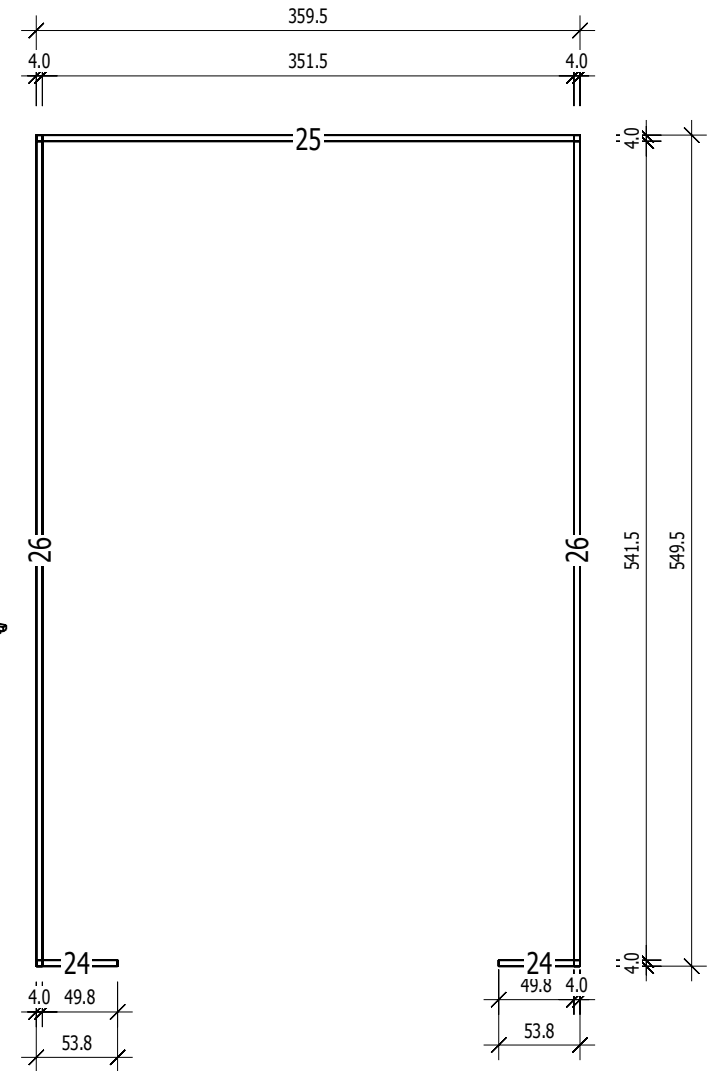

24

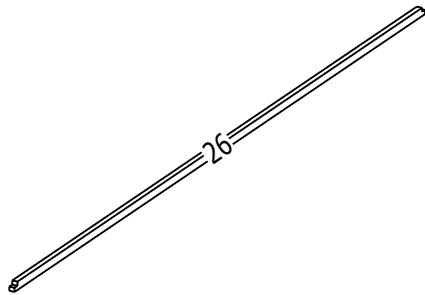

Nr.	B [cm]	H [cm]	L [cm]	Psc
24	4,0	6,0	53,8	2
25	4,0	6,0	359,5	1
26	4,0	6,0	549,5	2

24

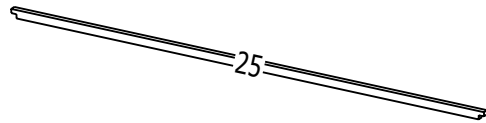
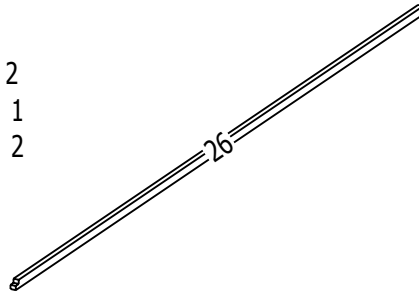

A
M 1:40

4,5

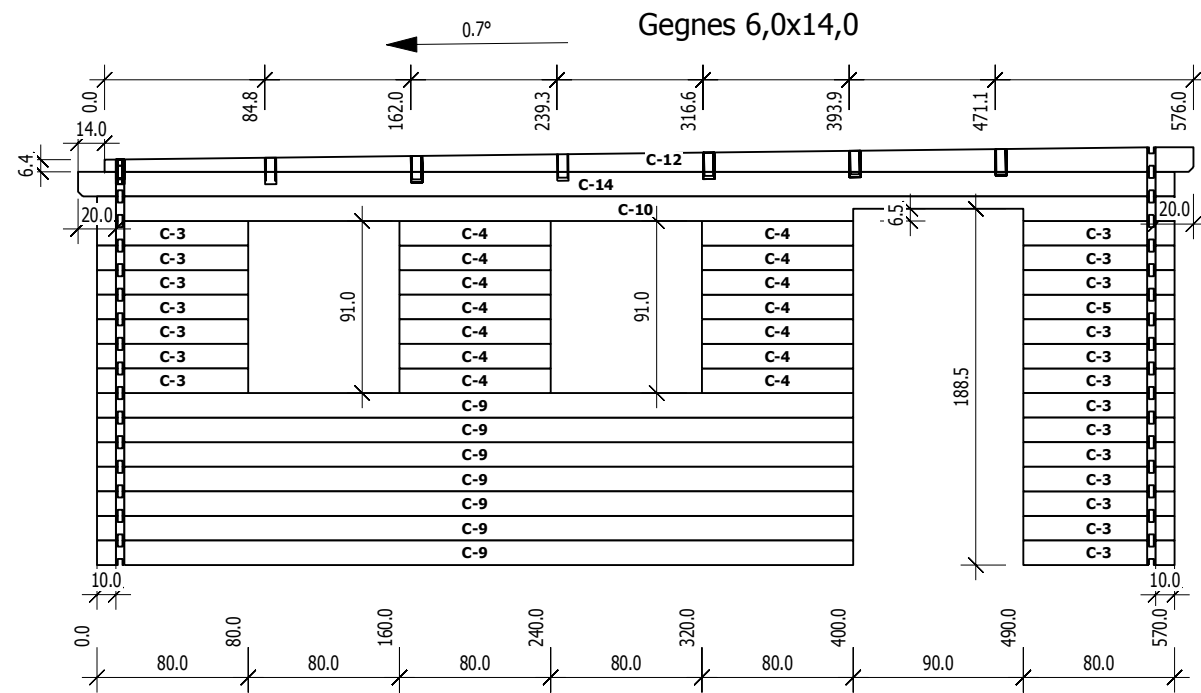
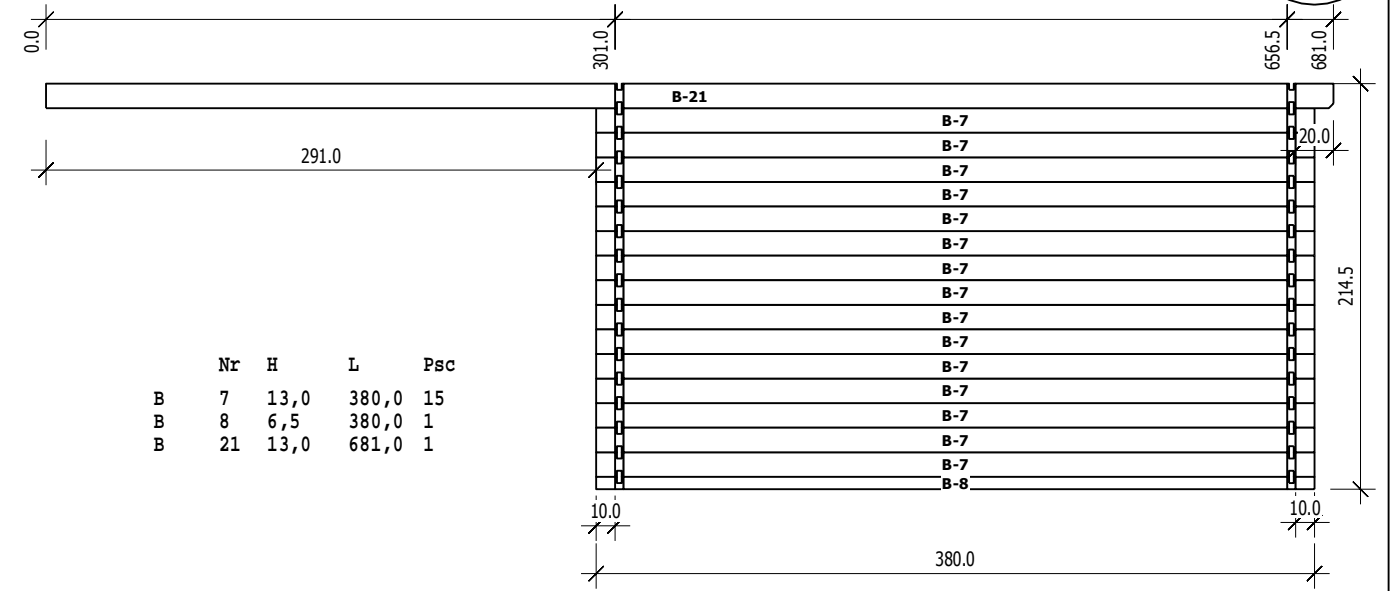
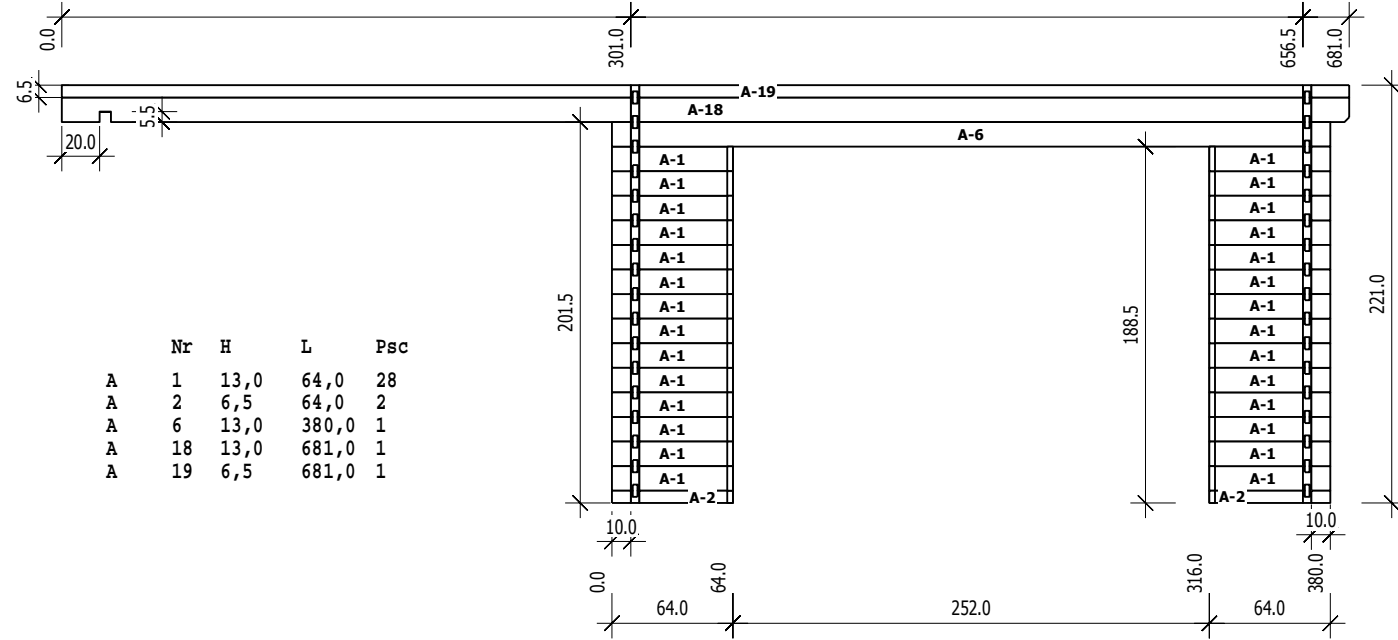

Nr	H	L	Psc
C 3	13,0	80,0	20
C 4	13,0	80,0	14
C 5	13,0	80,0	1
C 9	13,0	400,0	7
C 10	13,0	570,0	1
C 12	13,0	576,0	1
C 14	13,0	580,0	1

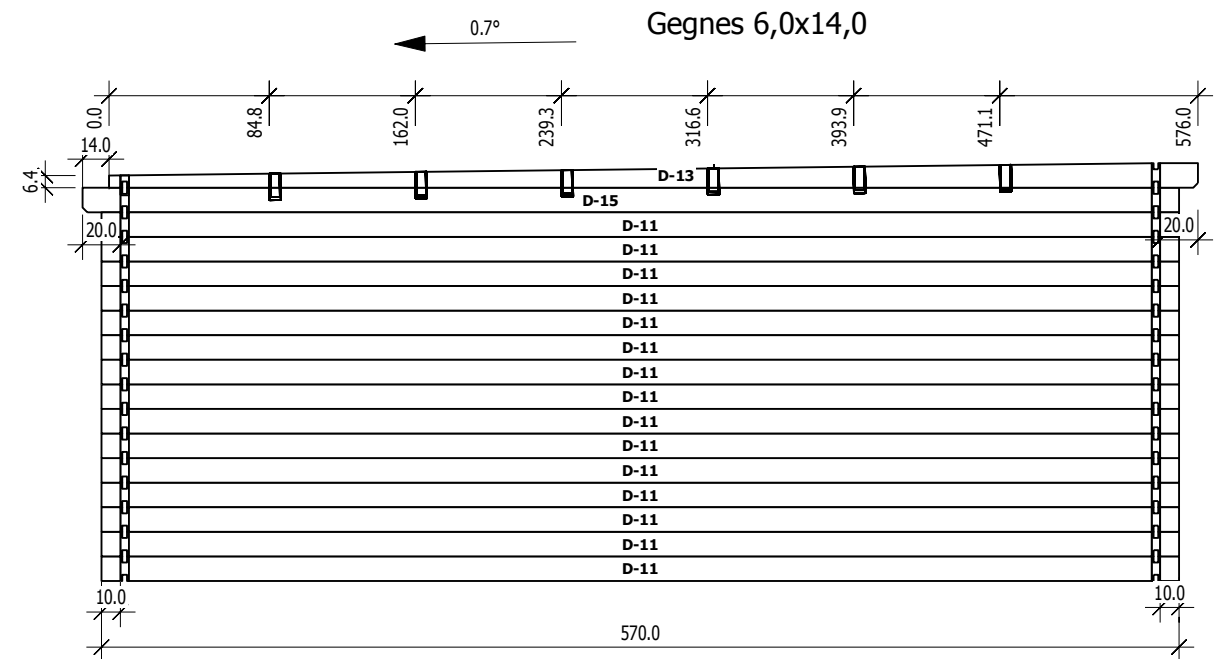

Nr	H	L	Psc
D 11	13,0	570,0	15
D 13	13,0	576,0	1
D 15	13,0	580,0	1