

Bemerkung: die Ansicht von Turen, Fenster und anderen Teilen kann abweichen von diesem Bild

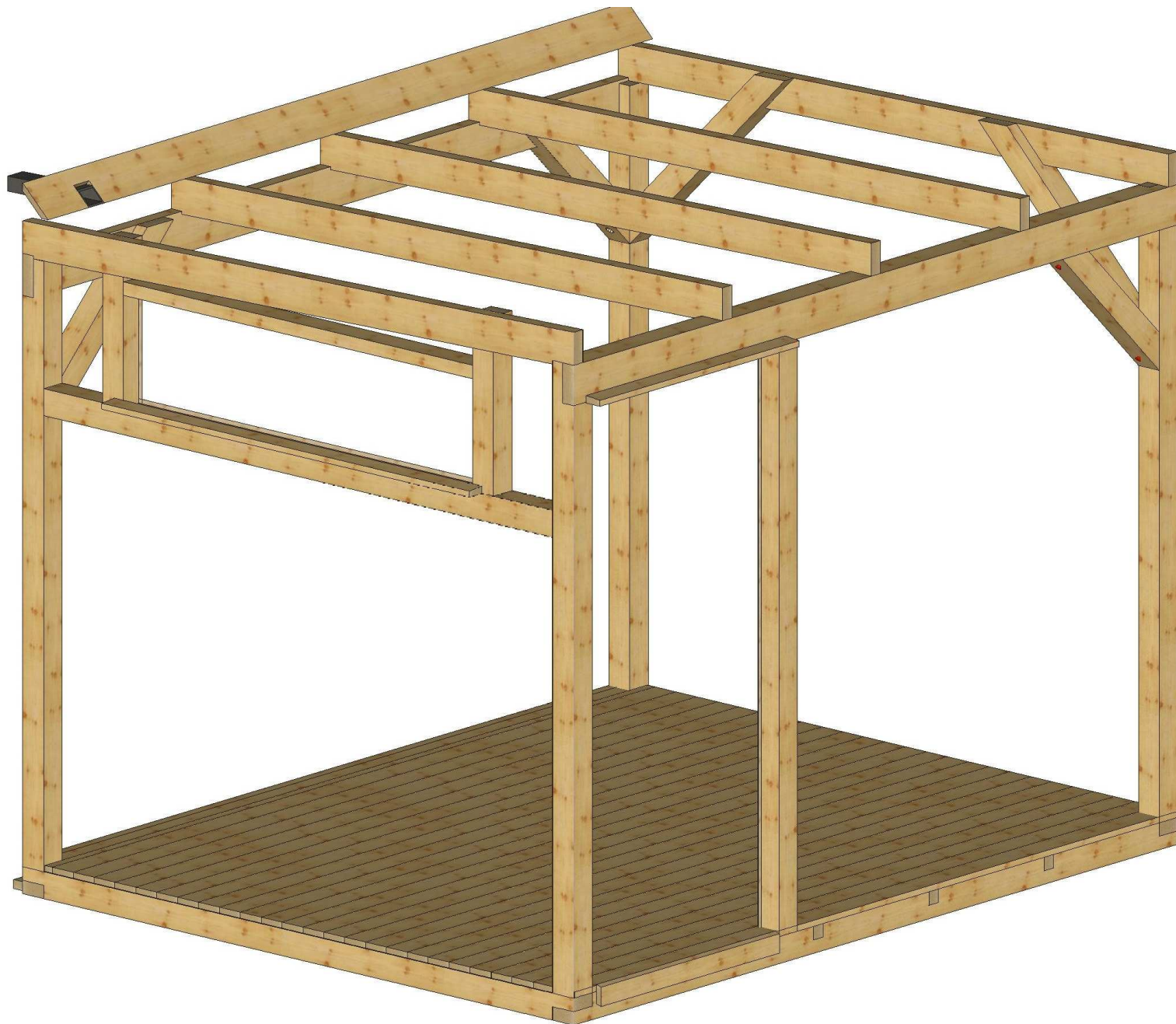

Bemerkung: die Ansicht von Türen, Fenster und anderen Teilen kann abweichen von diesem Bild

# Grundriss

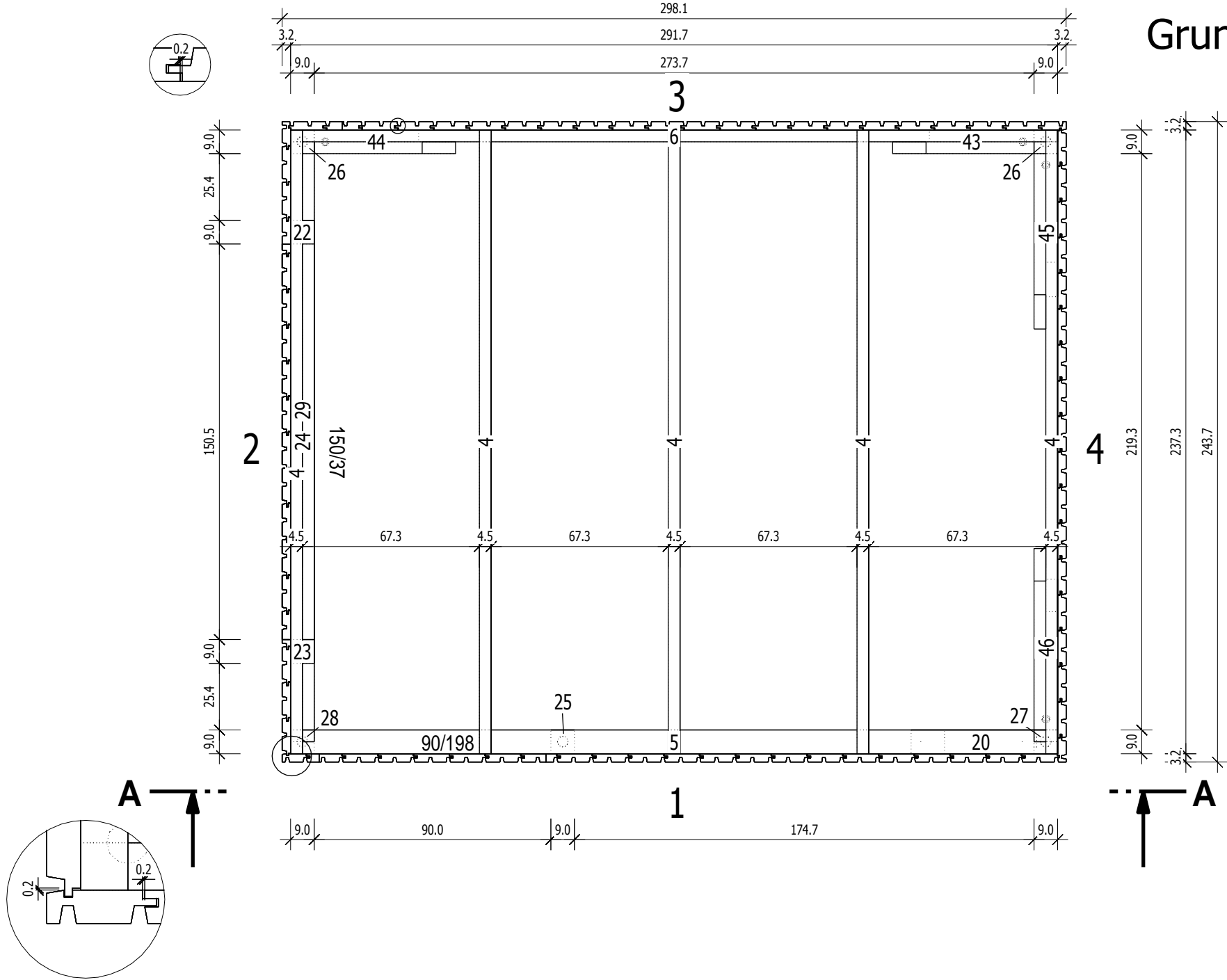

# Schnitt

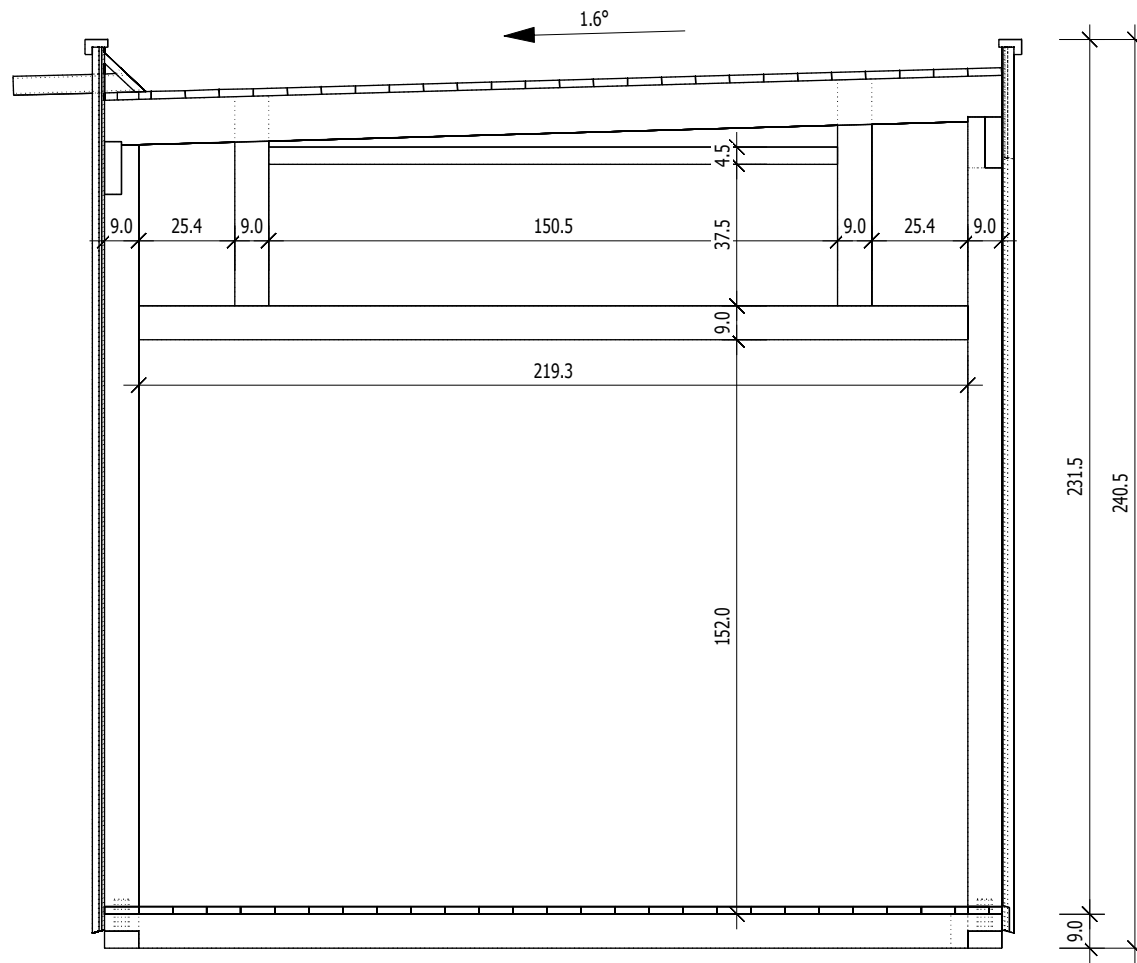

# Schnitt A-A

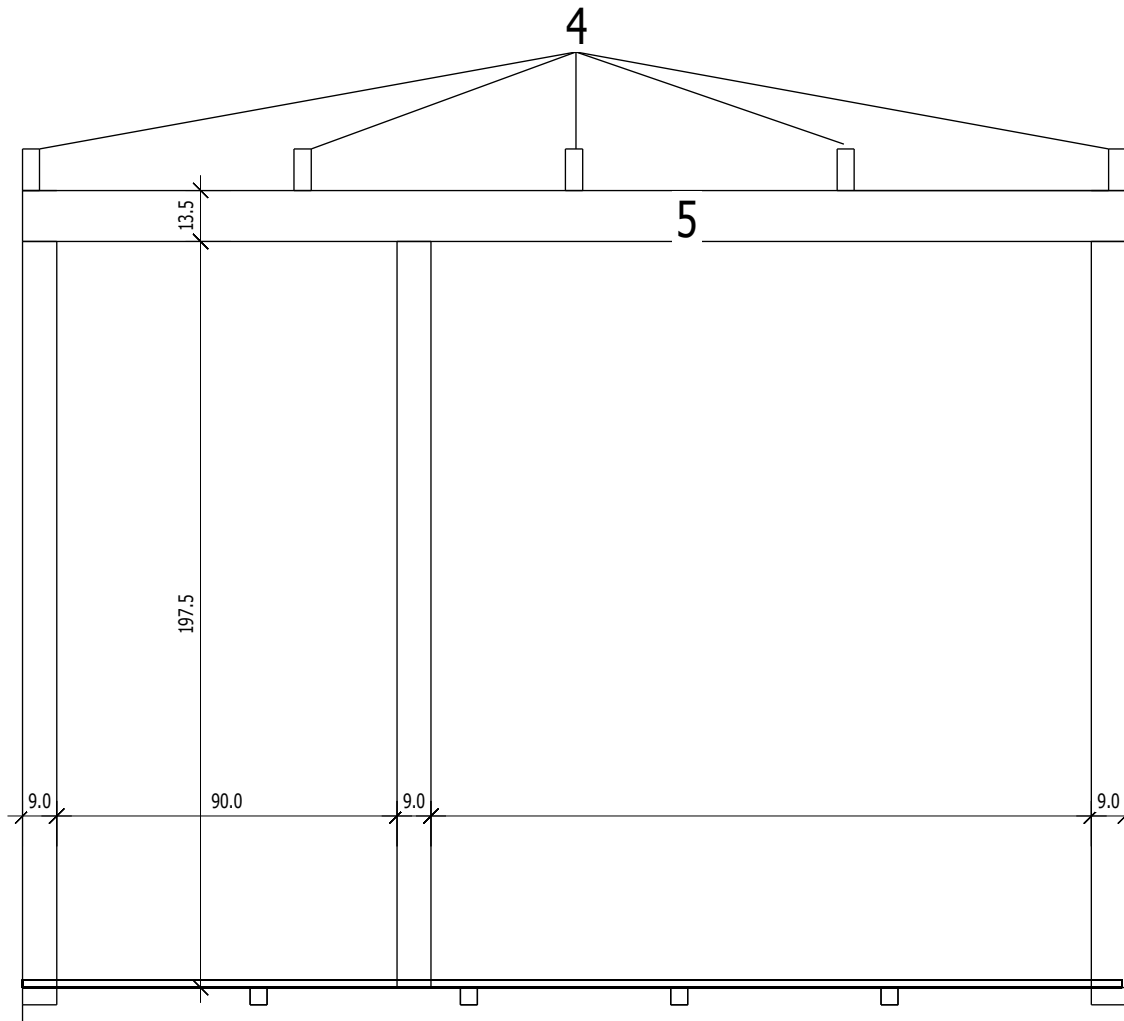

# Grundrahmenplan

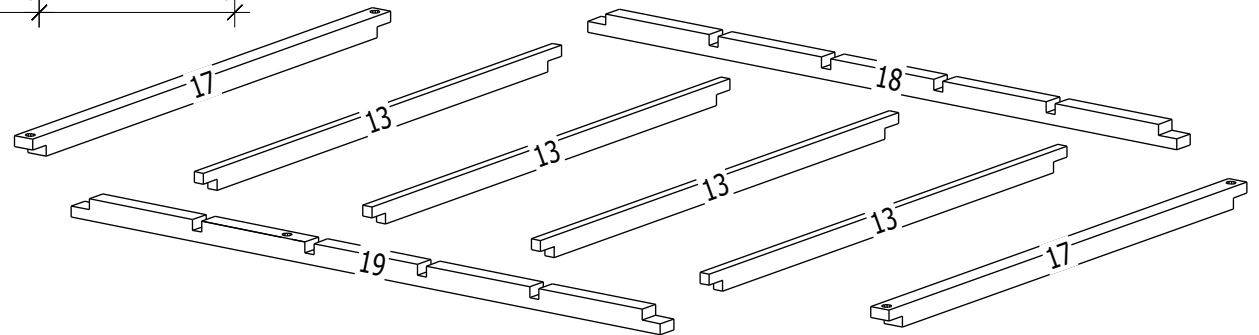
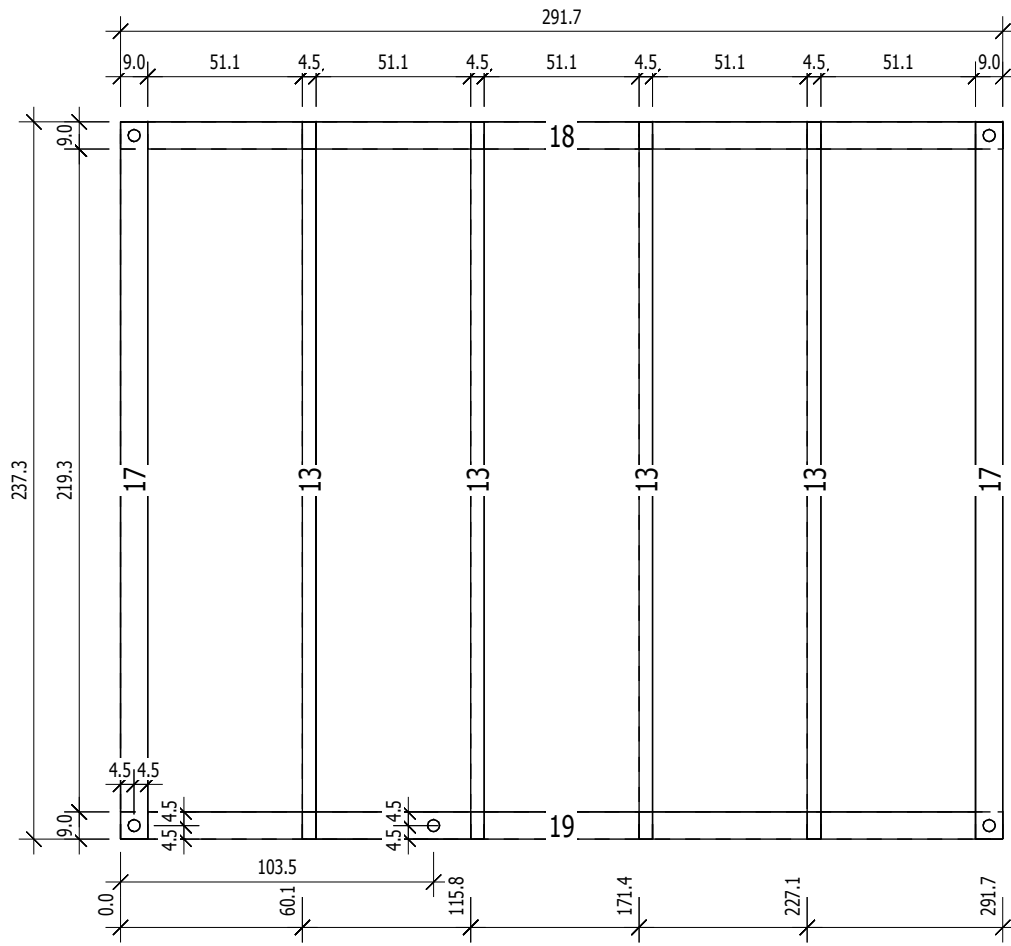

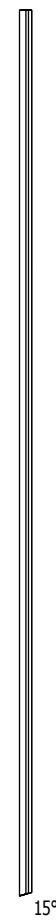
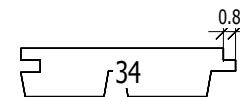
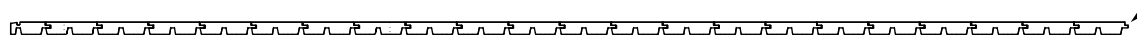
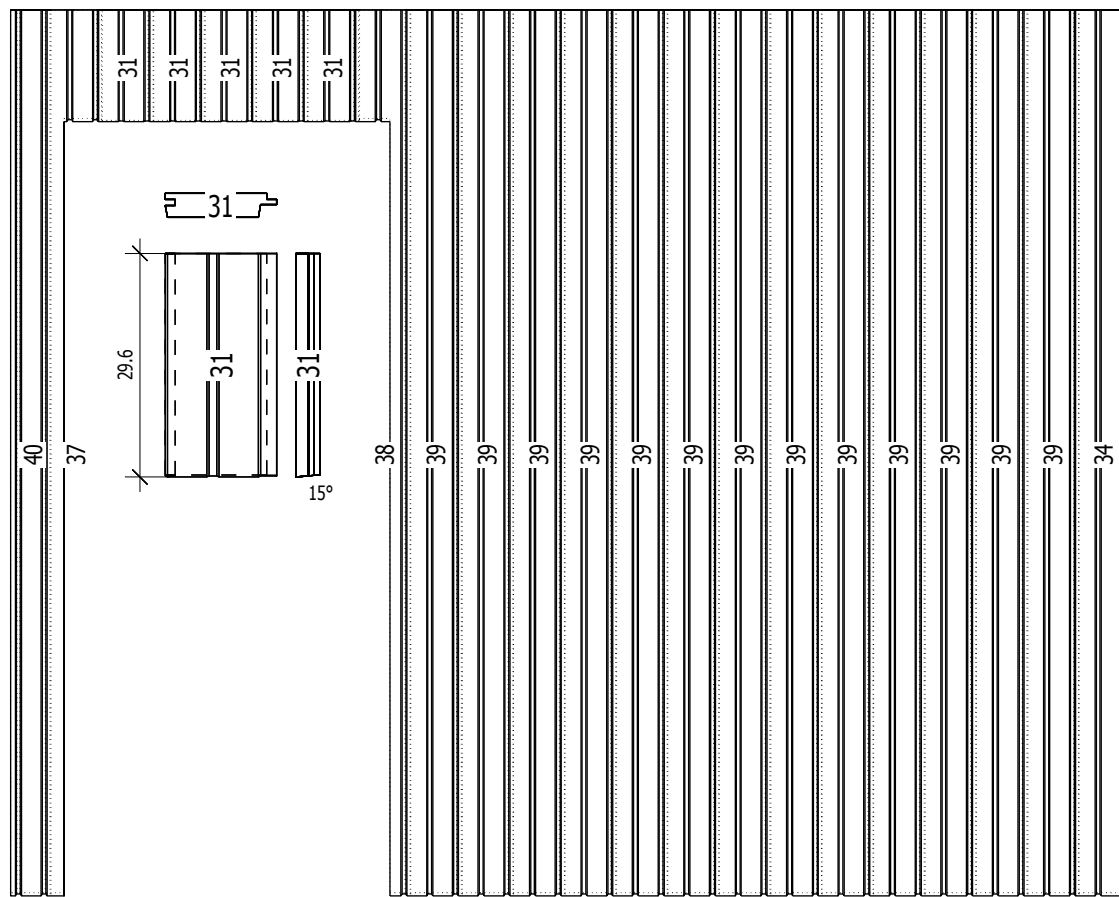
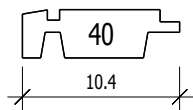
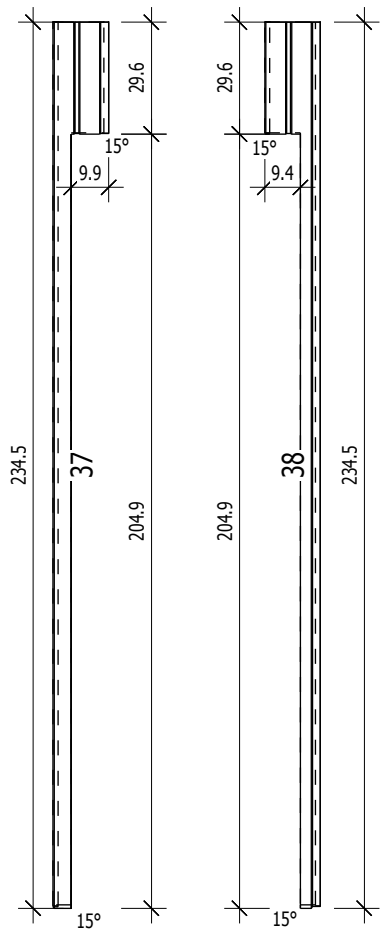

# Siena (Wand) Nr-2; Egle

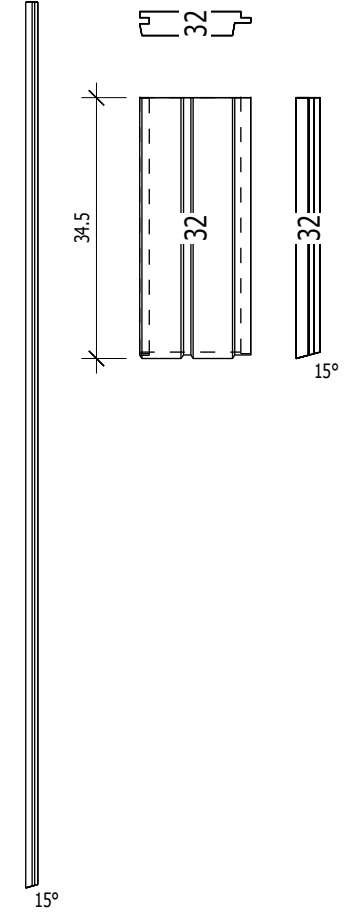
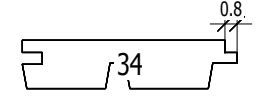
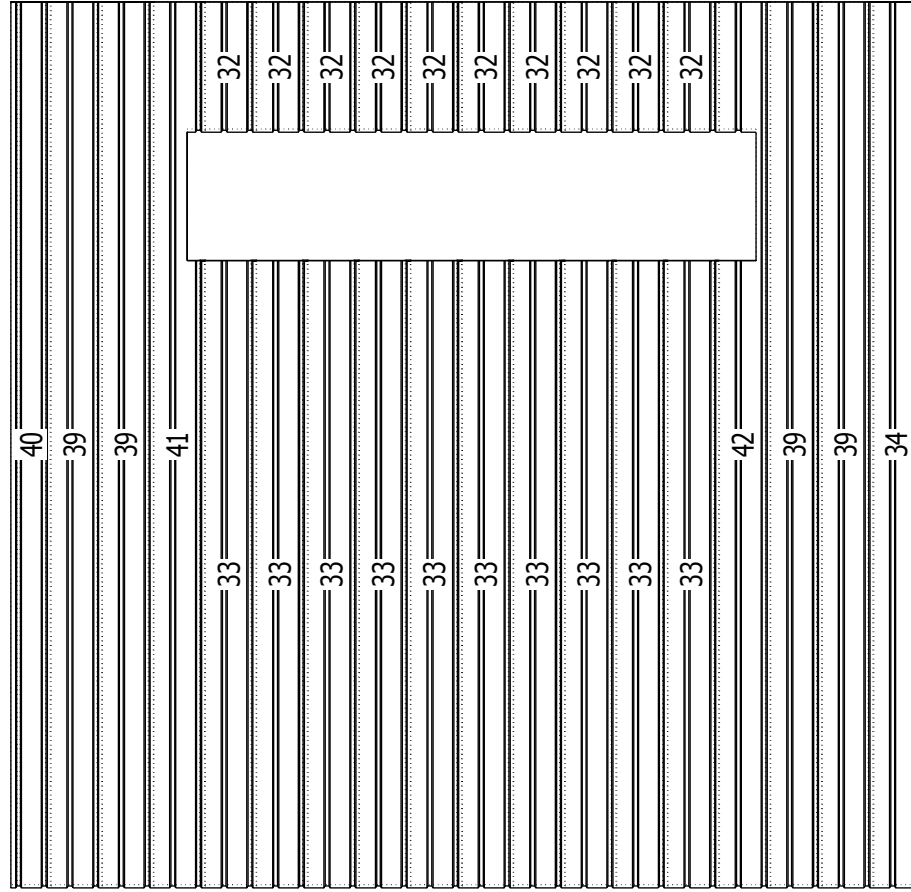
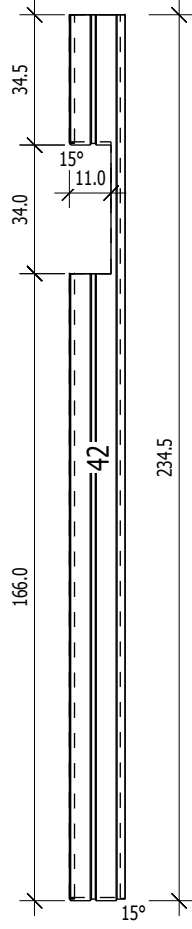
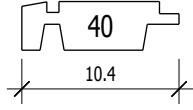
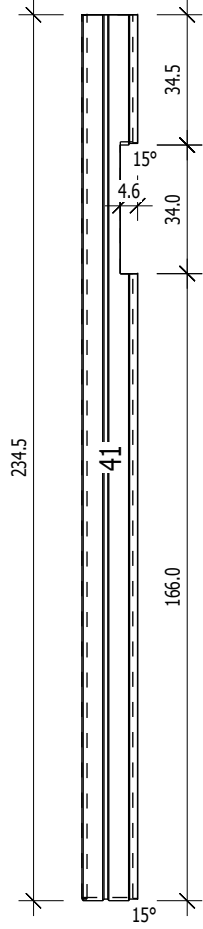



# Siena (Wand) Nr-3; Egle

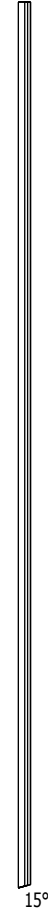
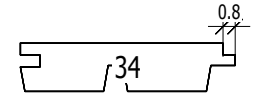
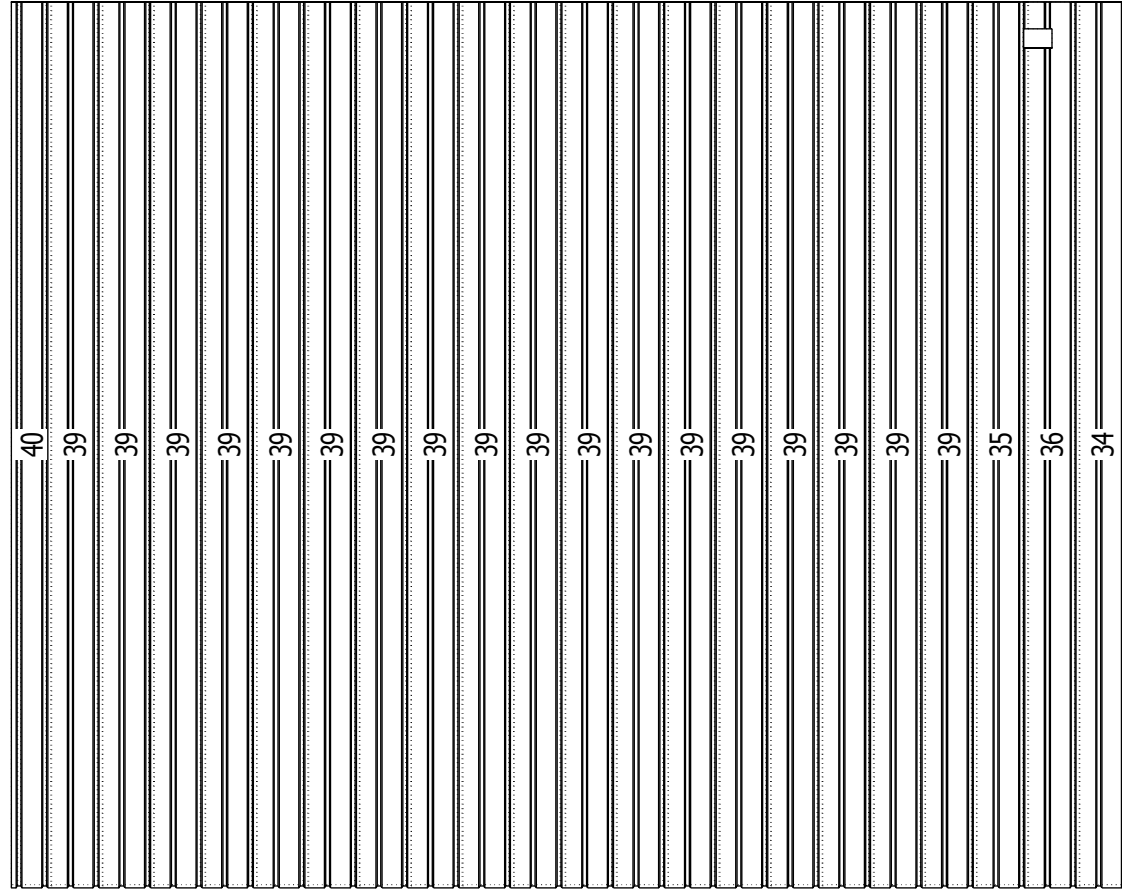
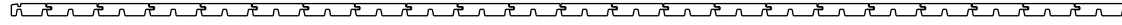
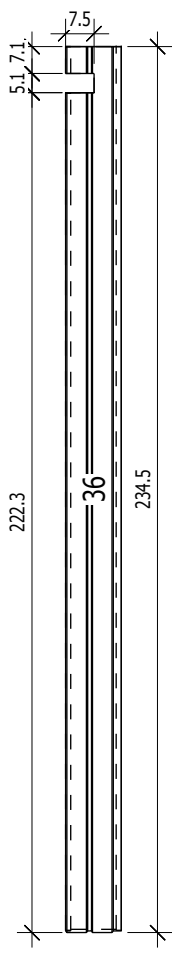
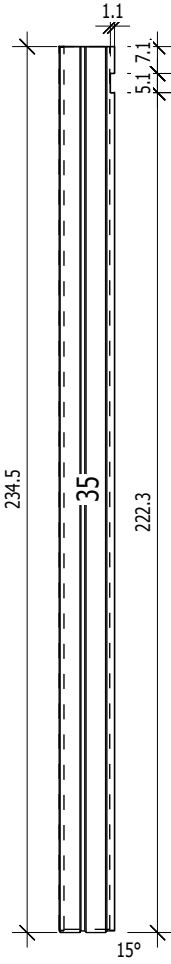
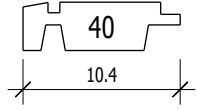

# Siena (Wand) Nr-4; Egle

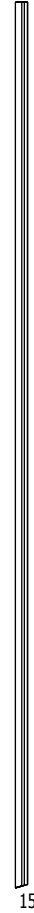
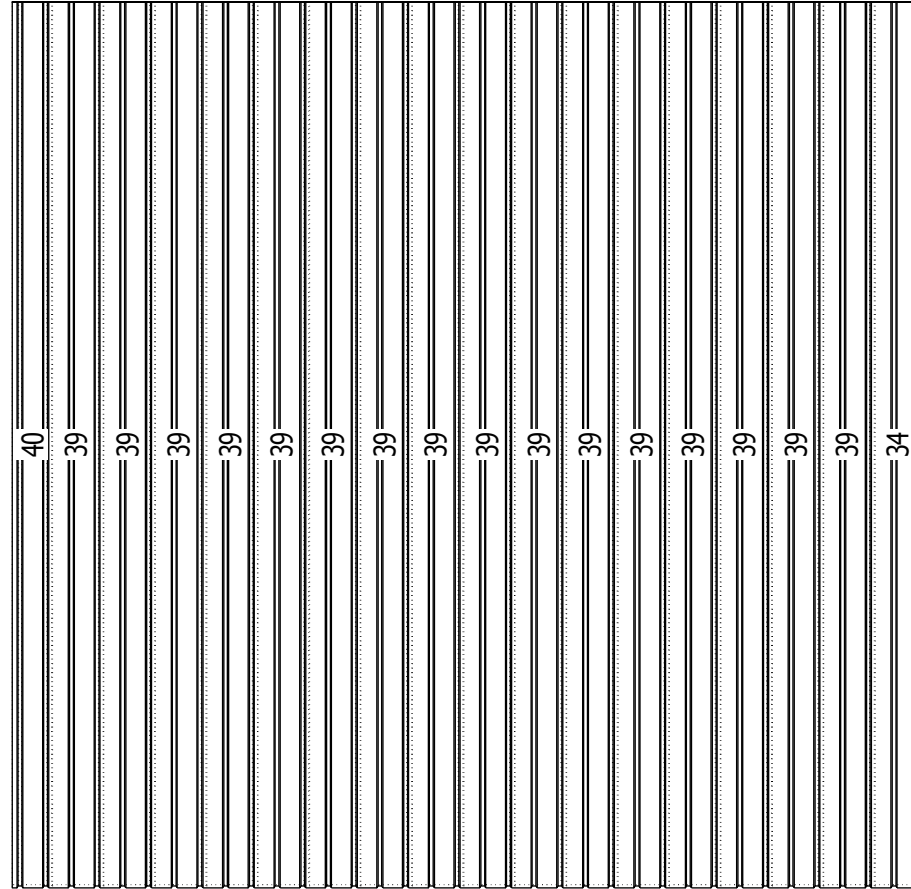
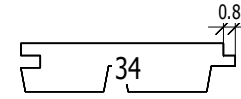
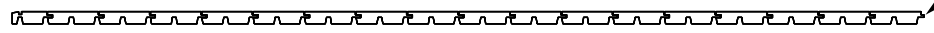
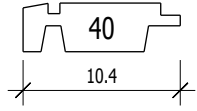

15°