

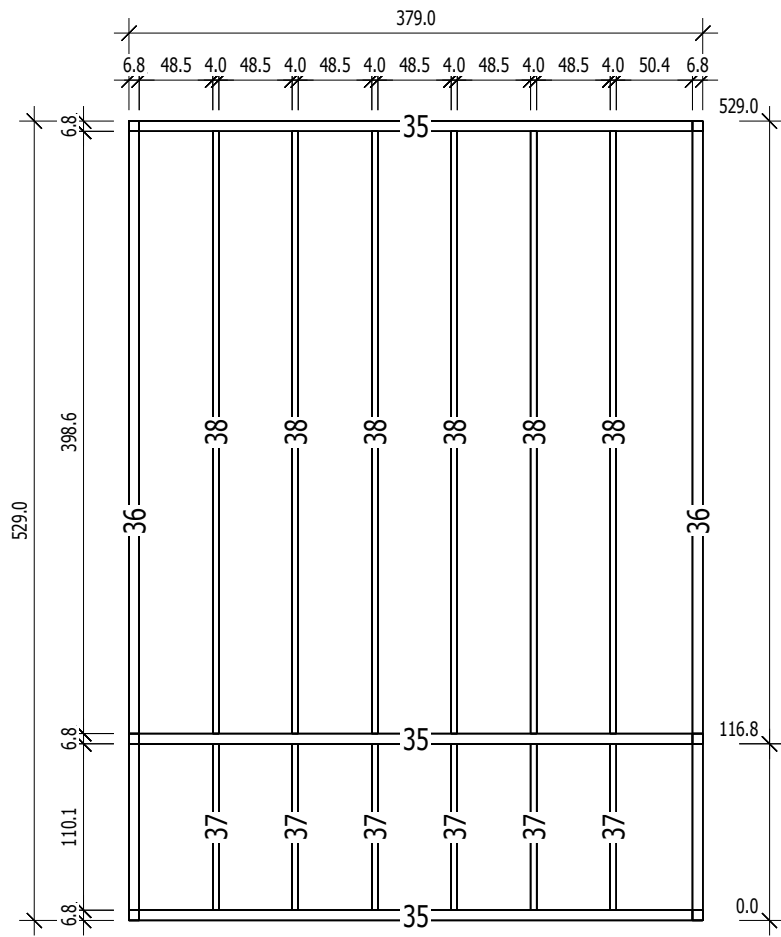

Bemerkung: die Ansicht von Turen, Fenster und anderen Teilen kann abweichen von diesem Bild







# Grundrahmenplan

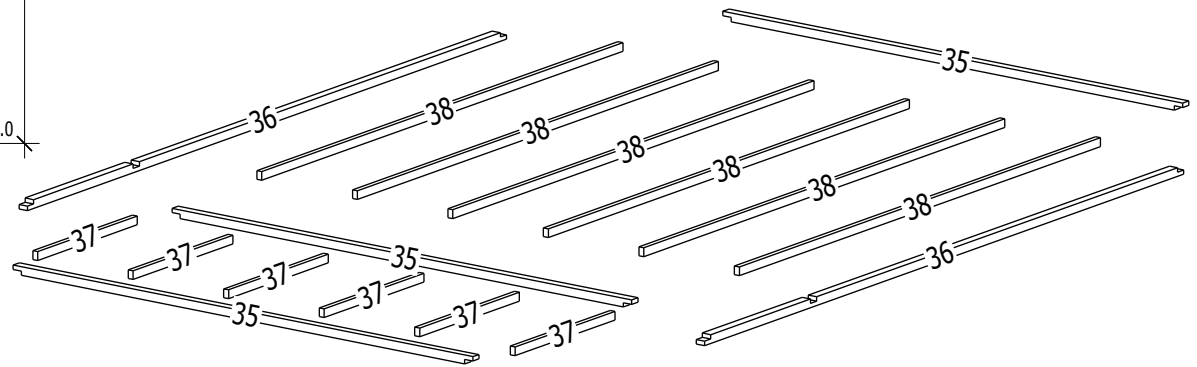

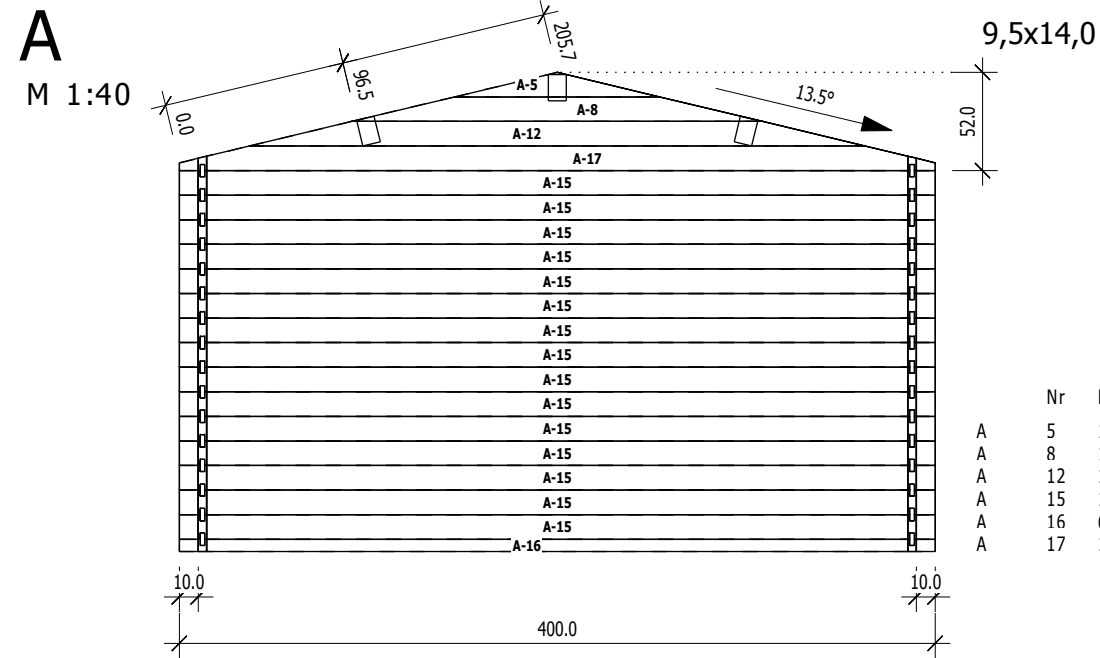

	Nr	H	L	Psc
A	5	13.0	108.6	1
A	8	13.0	217.1	1
A	12	13.0	325.7	1
A	15	13.0	400.0	15
A	16	6.5	400.0	1
A	17	13.0	400.0	1

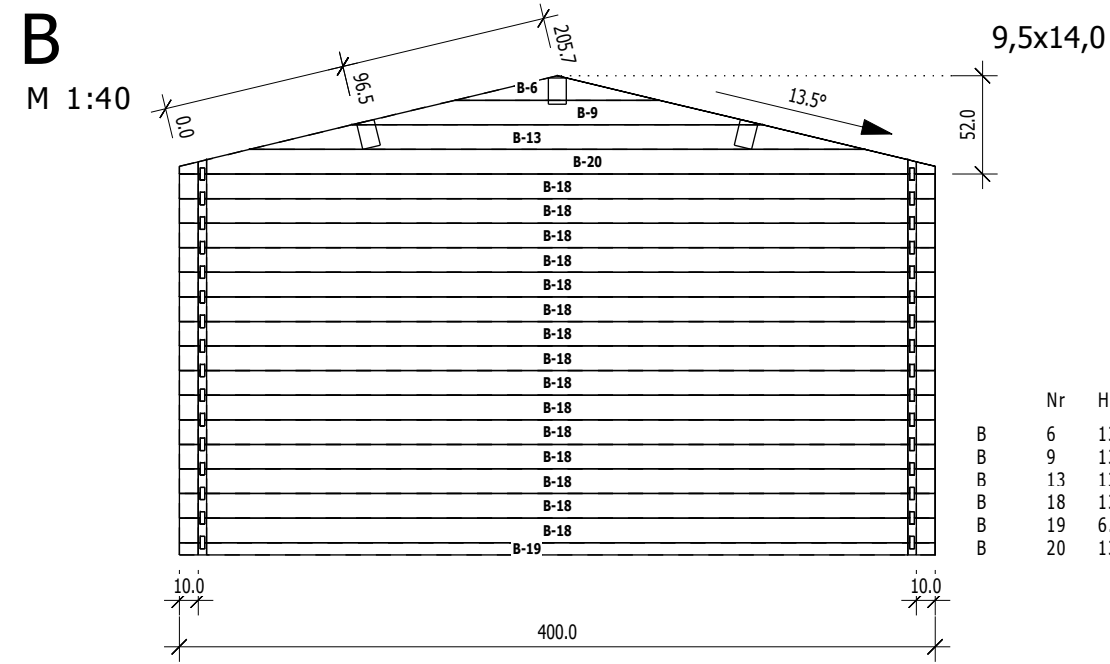

	Nr	H	L	Psc
B	6	13.0	108.6	1
B	9	13.0	217.1	1
B	13	13.0	325.7	1
B	18	13.0	400.0	15
B	19	6.5	400.0	1
B	20	13.0	400.0	1

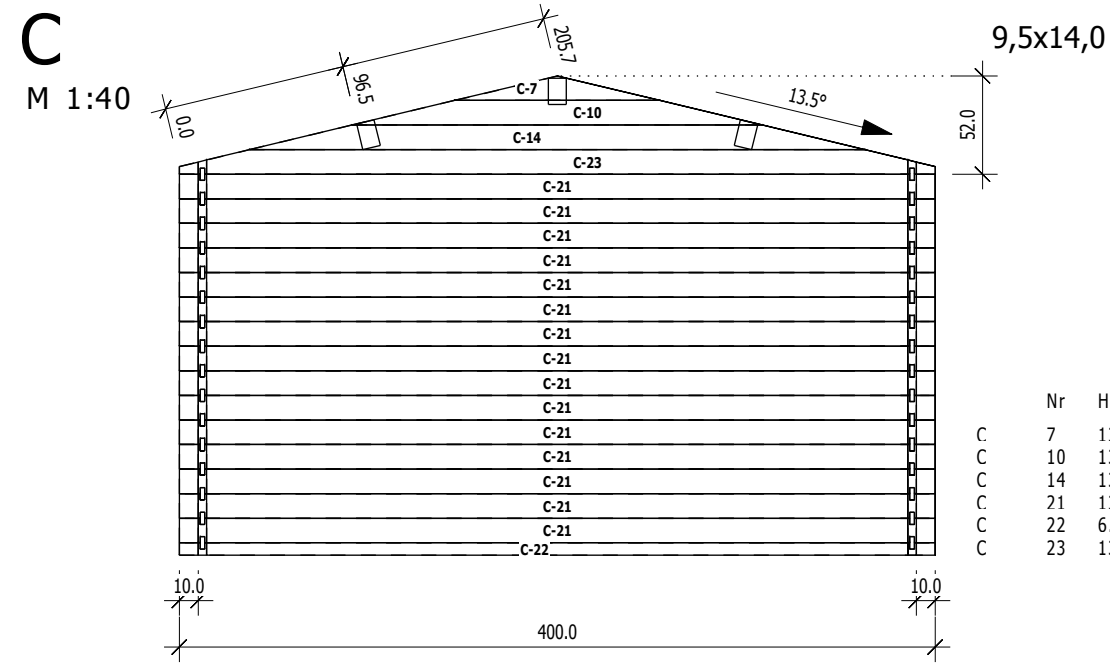

	Nr	H	L	Psc
C	7	13.0	108.6	1
C	10	13.0	217.1	1
C	14	13.0	325.7	1
C	21	13.0	400.0	15
C	22	6.5	400.0	1
C	23	13.0	400.0	1

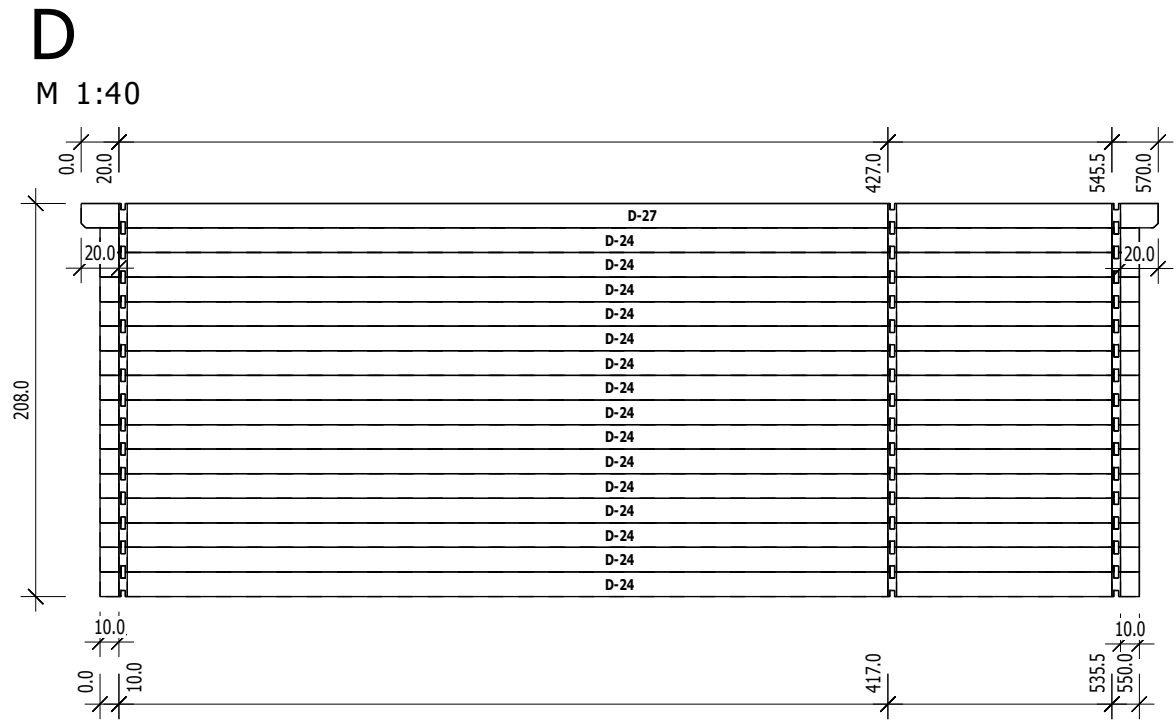

	Nr	H	L	Psc
D	24	13.0	550.0	15
D	27	13.0	570.0	1

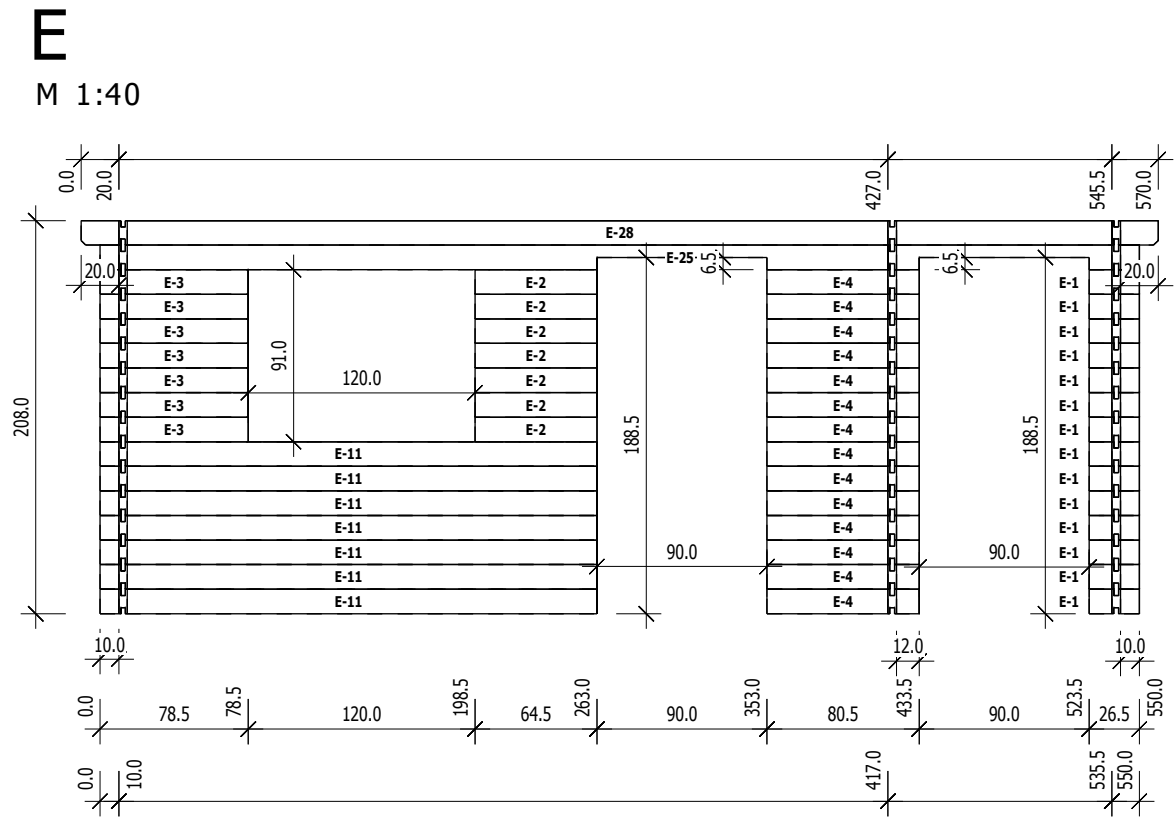

	Nr	H	L	Psc
E	1	13.0	26.5	14
E	2	13.0	64.5	7
E	3	13.0	78.5	7
E	4	13.0	80.5	14
E	11	13.0	263.0	7
E	25	13.0	550.0	1
E	28	13.0	570.0	1