

Bemerkung: die Ansicht von Turen, Fenster und anderen Teilen kann abweichen von diesem Bild

Grundriss

3,0

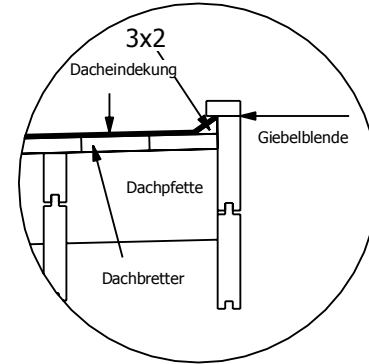
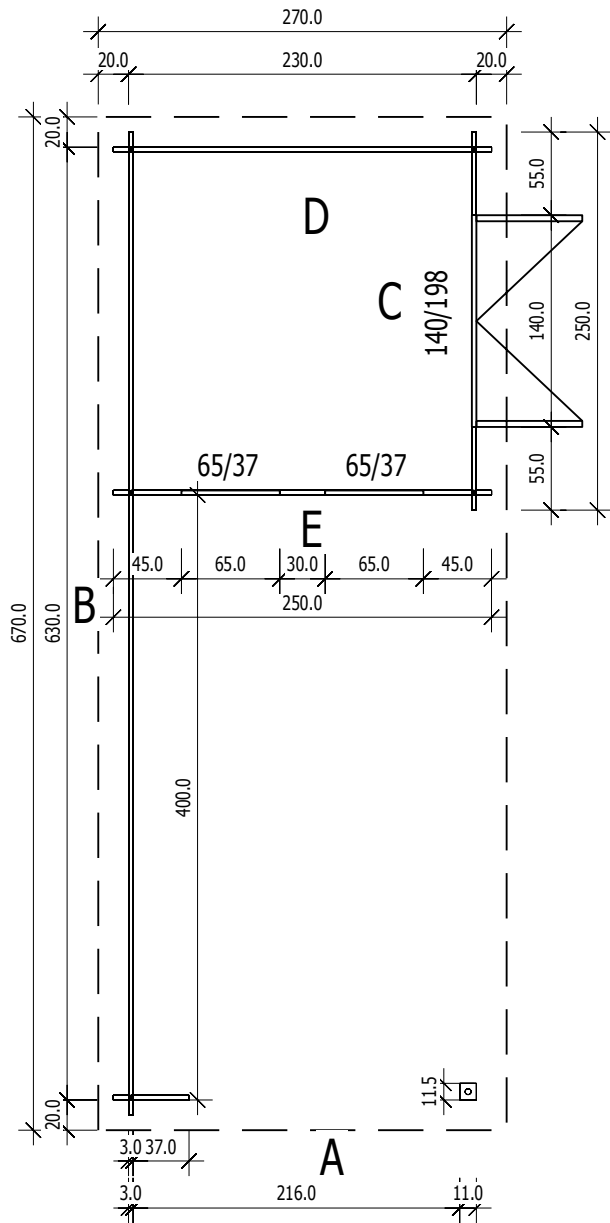

9,5x14,0

Schnitt

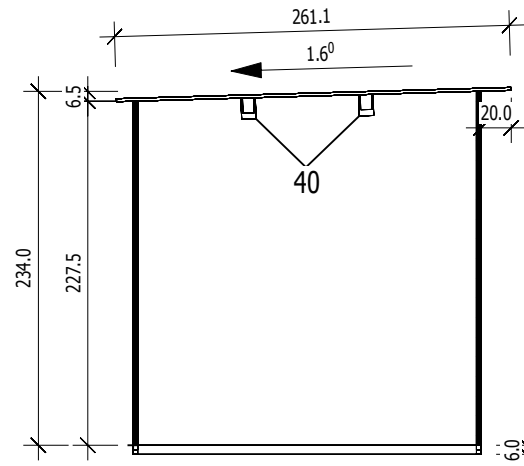

Grundrahmenplan

3,0

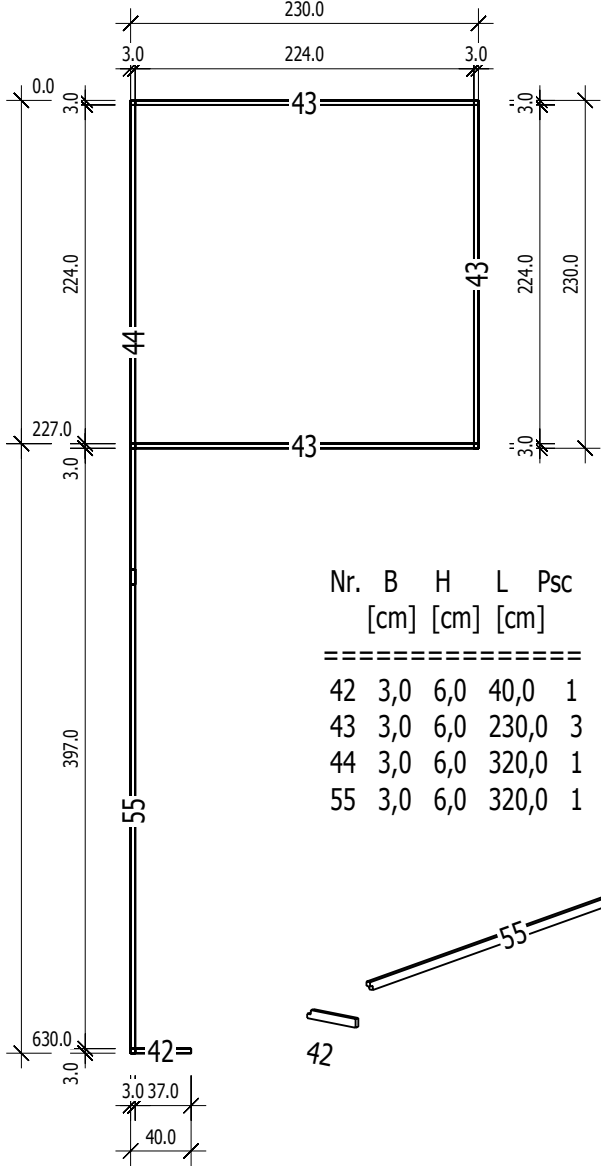

Nr.	B [cm]	H [cm]	L [cm]	Psc
42	3,0	6,0	40,0	1
43	3,0	6,0	230,0	3
44	3,0	6,0	320,0	1
55	3,0	6,0	320,0	1

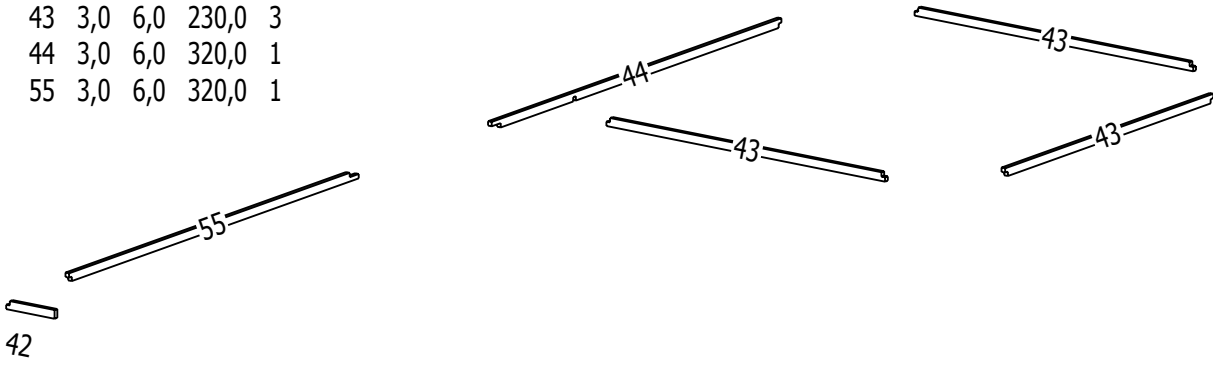
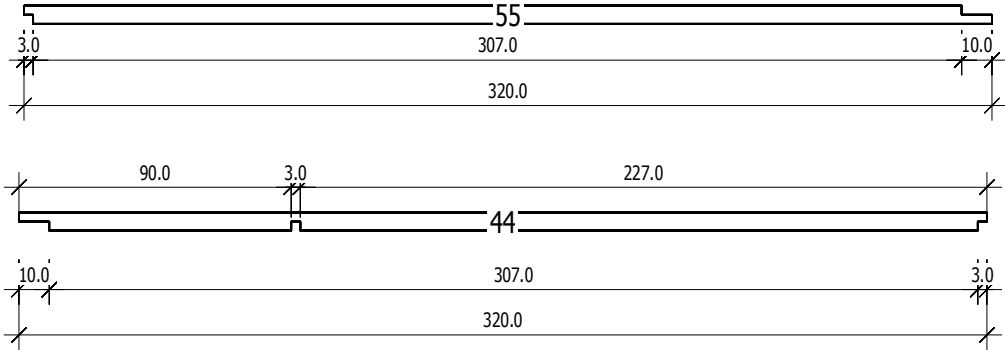

B
M 1:40

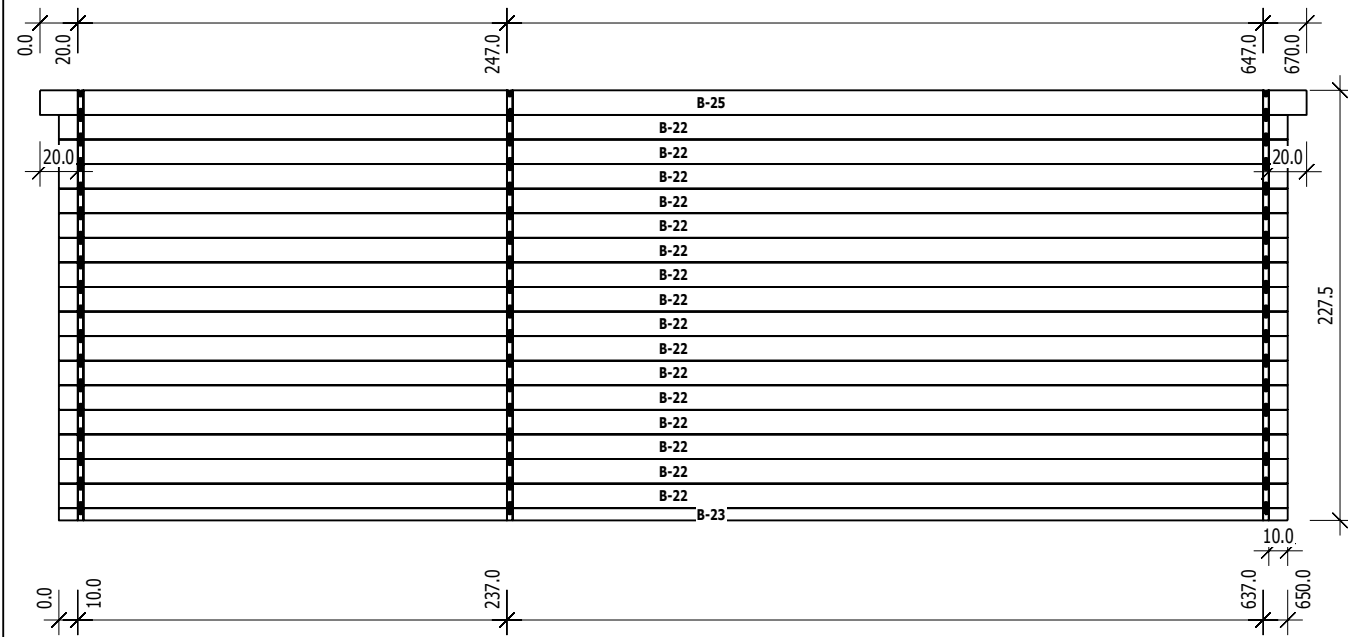

Nr	H	L	Psc
B 22	13.0	650.0	16
B 23	6.5	650.0	1
B 25	13.0	670.0	1

C
M 1:40

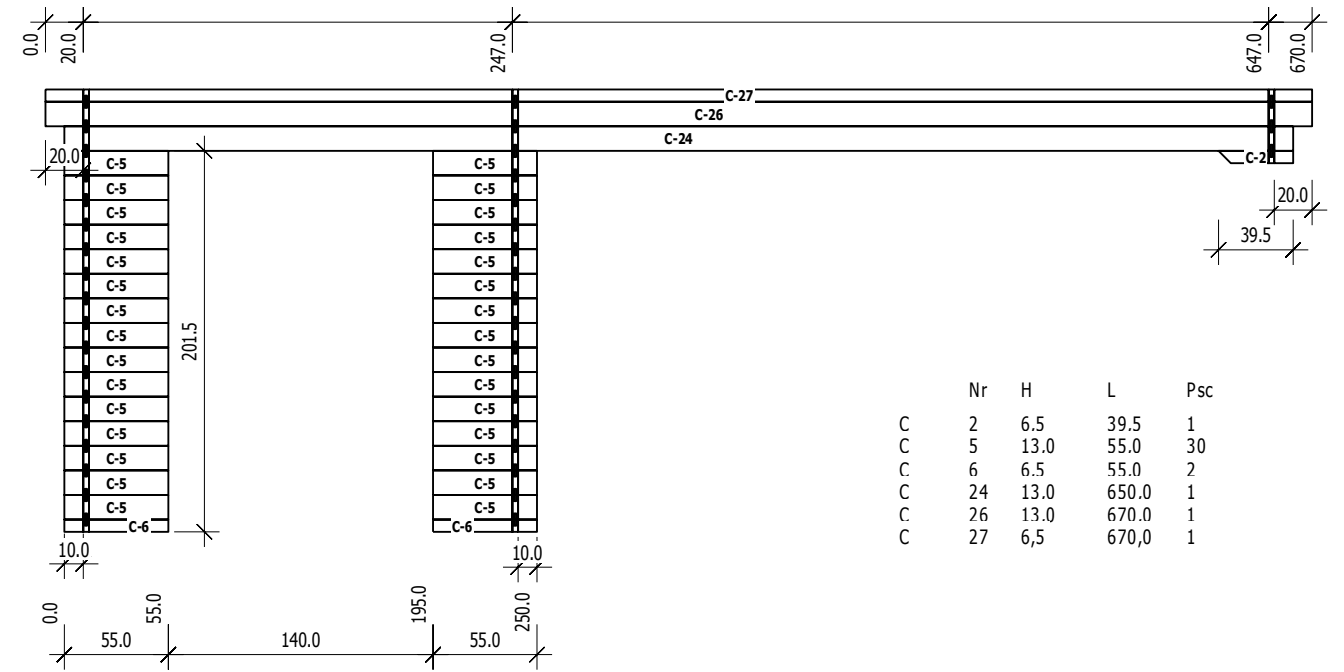

Nr	H	L	Psc
C 2	6.5	39.5	1
C 5	13.0	55.0	30
C 6	6.5	55.0	2
C 24	13.0	650.0	1
C 26	13.0	670.0	1
C 27	6.5	670.0	1

A
M 1:40

Gegnes 9,5x14,0

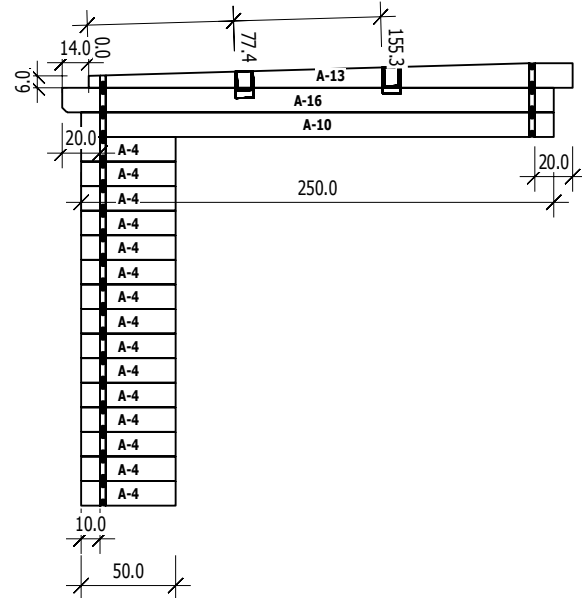

Nr	H	L	Psc
A 4	13.0	50.0	15
A 10	13.0	250.0	1
A 13	13.0	256.0	1
A 16	13.0	260.0	1

D
M 1:40

Gegnes 9,5x14,0

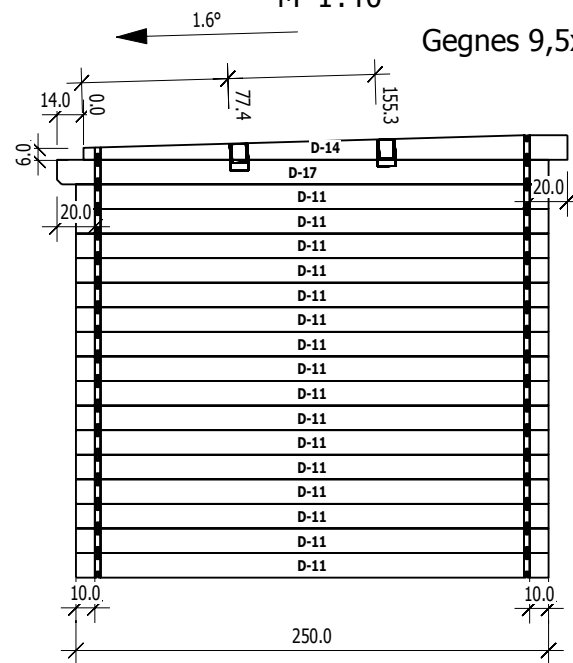

Nr	H	L	Psc
D 11	13.0	250.0	16
D 14	13.0	256.0	1
D 17	13.0	260.0	1

E
M 1:40

Gegnes 9,5x14,0

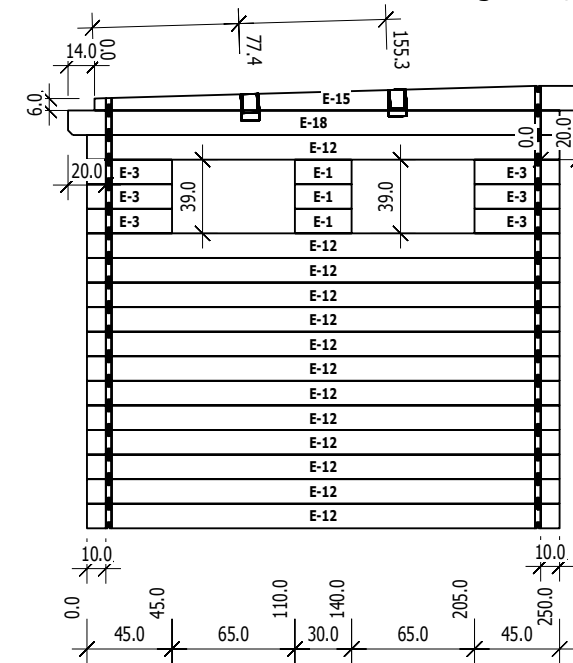

Nr	H	L	Psc
E 1	13.0	30.0	3
E 3	13.0	45.0	6
E 12	13.0	250.0	13
E 15	13.0	256.0	1
E 18	13.0	260.0	1