

W 4x4+3+A | 50 | 12

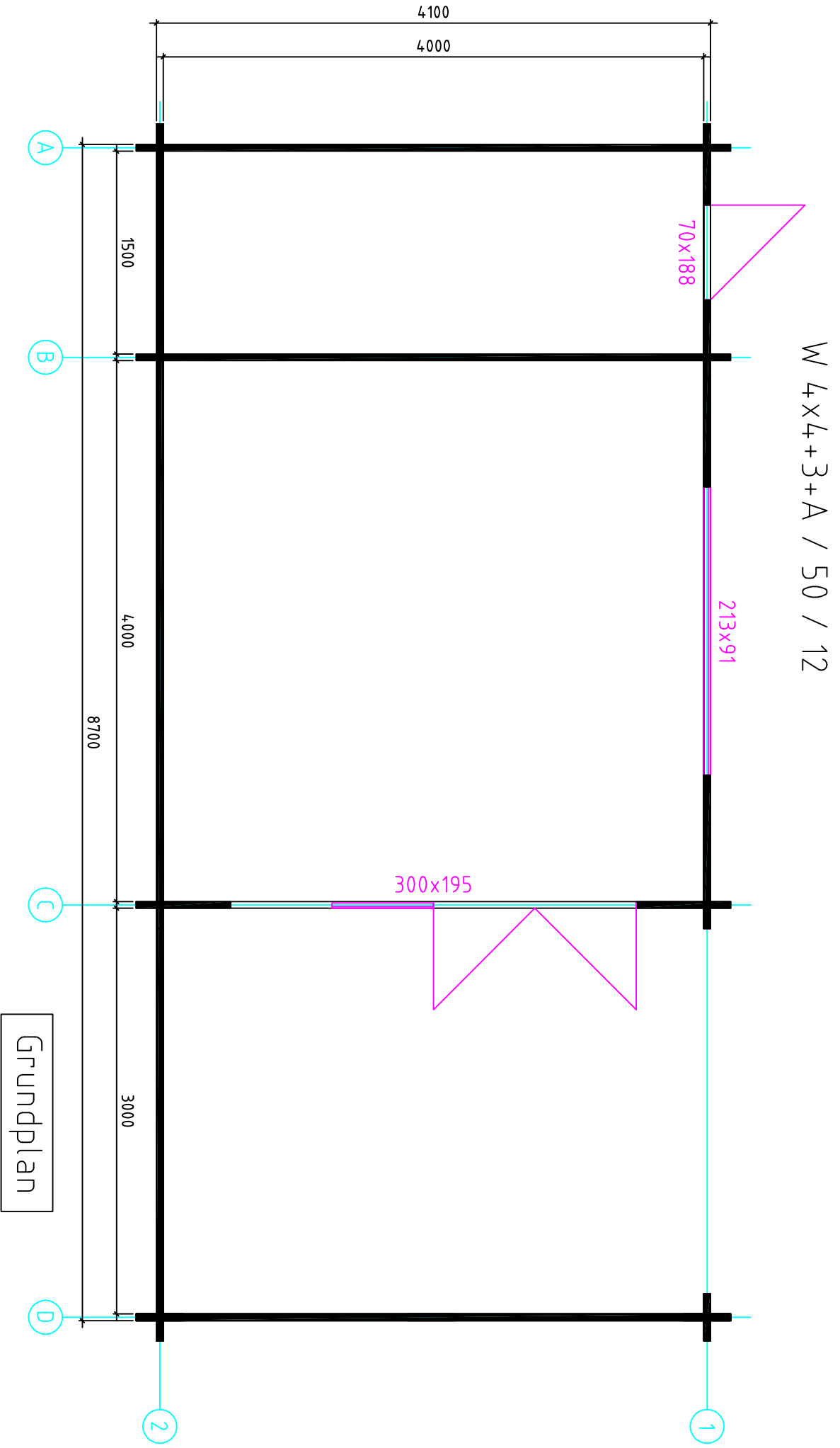

Grundplan

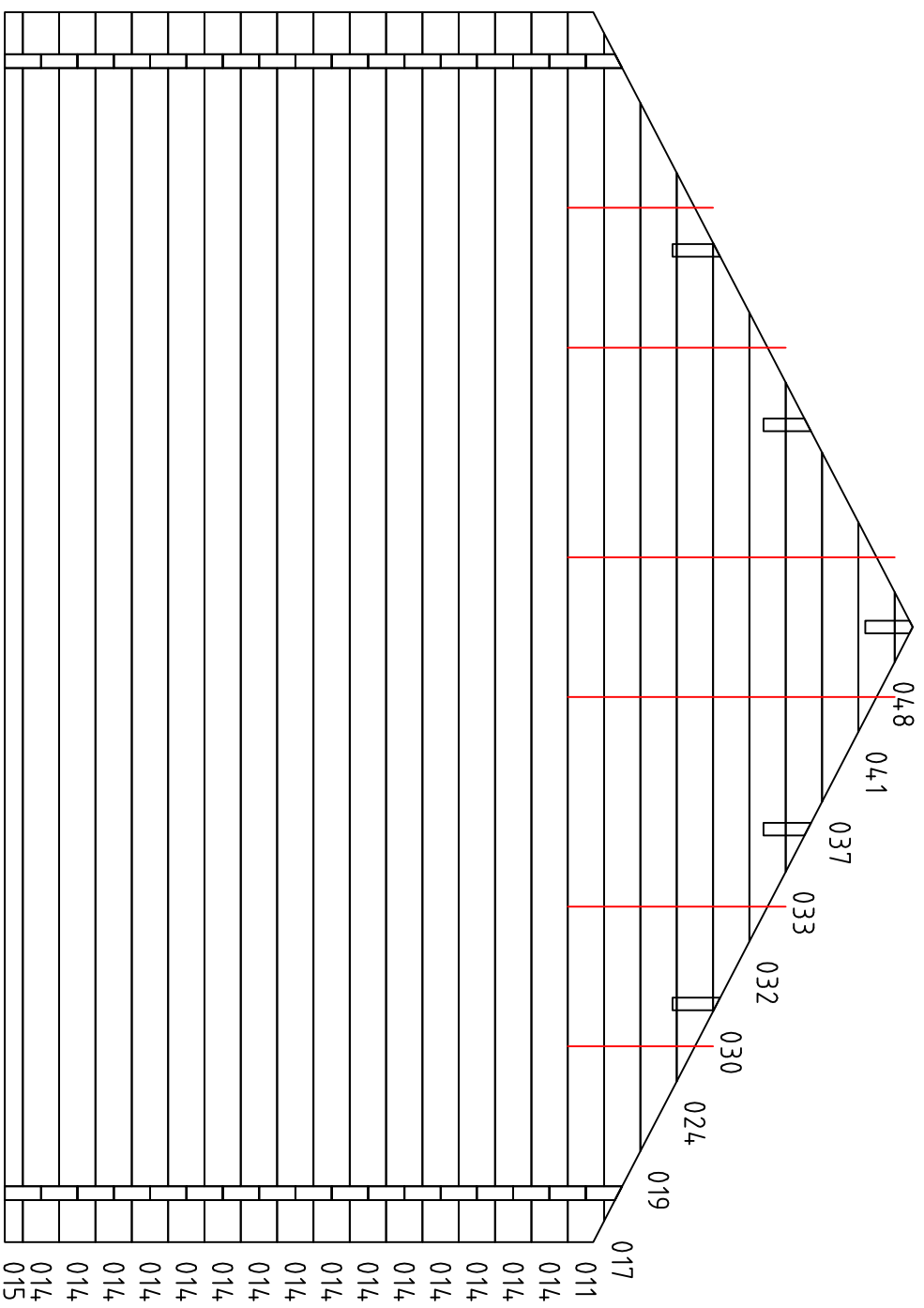

Wand B ↗

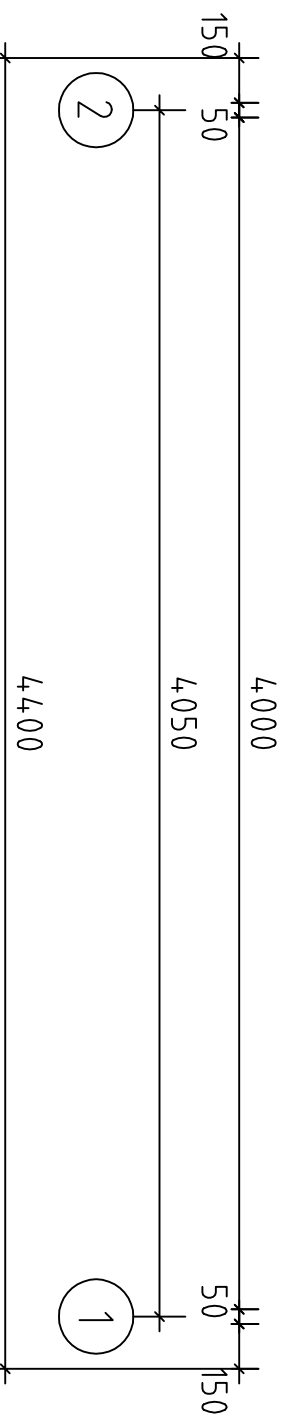

W 4x4+3+A / 50 / 12

Wand C ↗

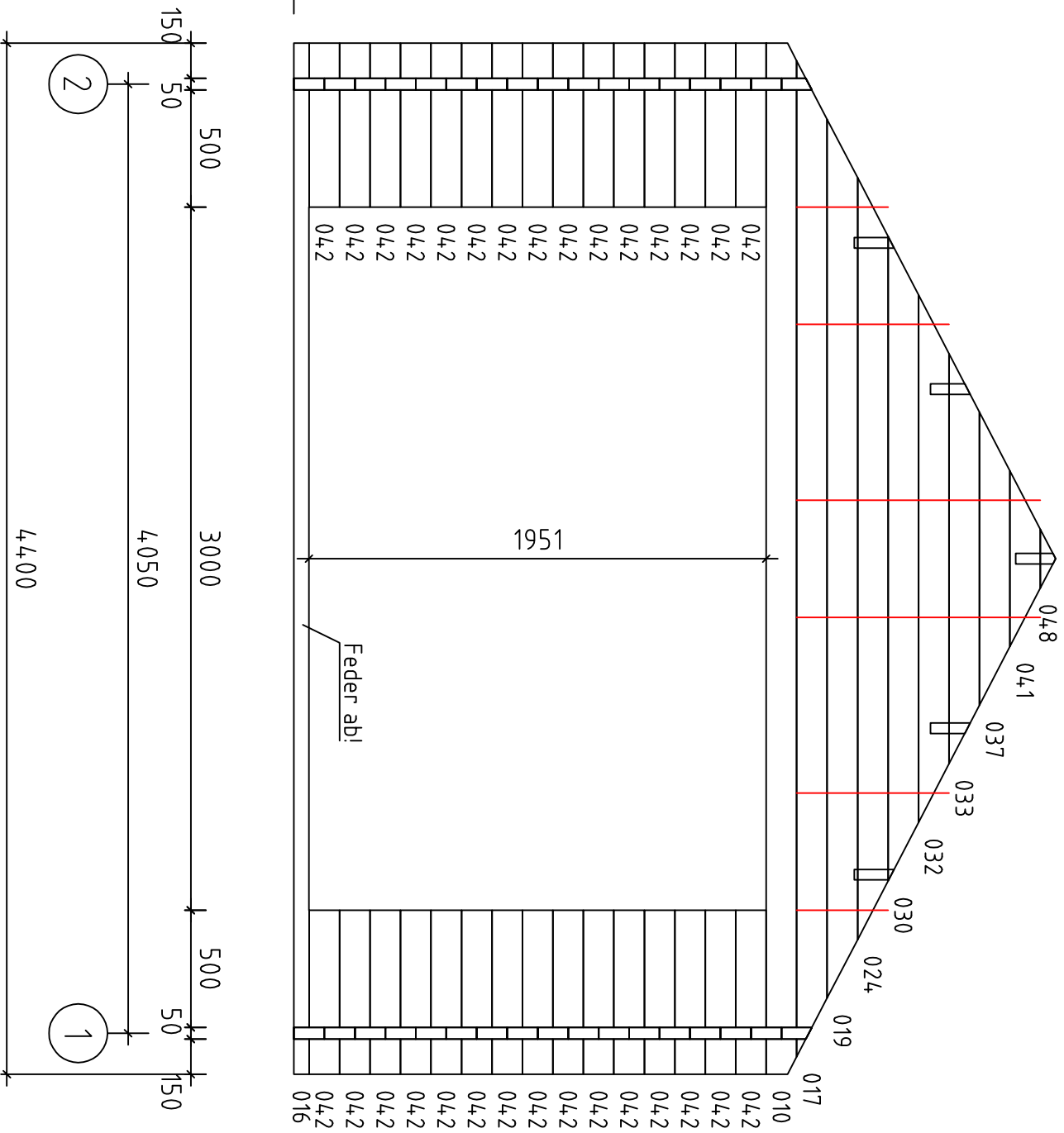

W 4x4 + 3 + A / 50 / 12

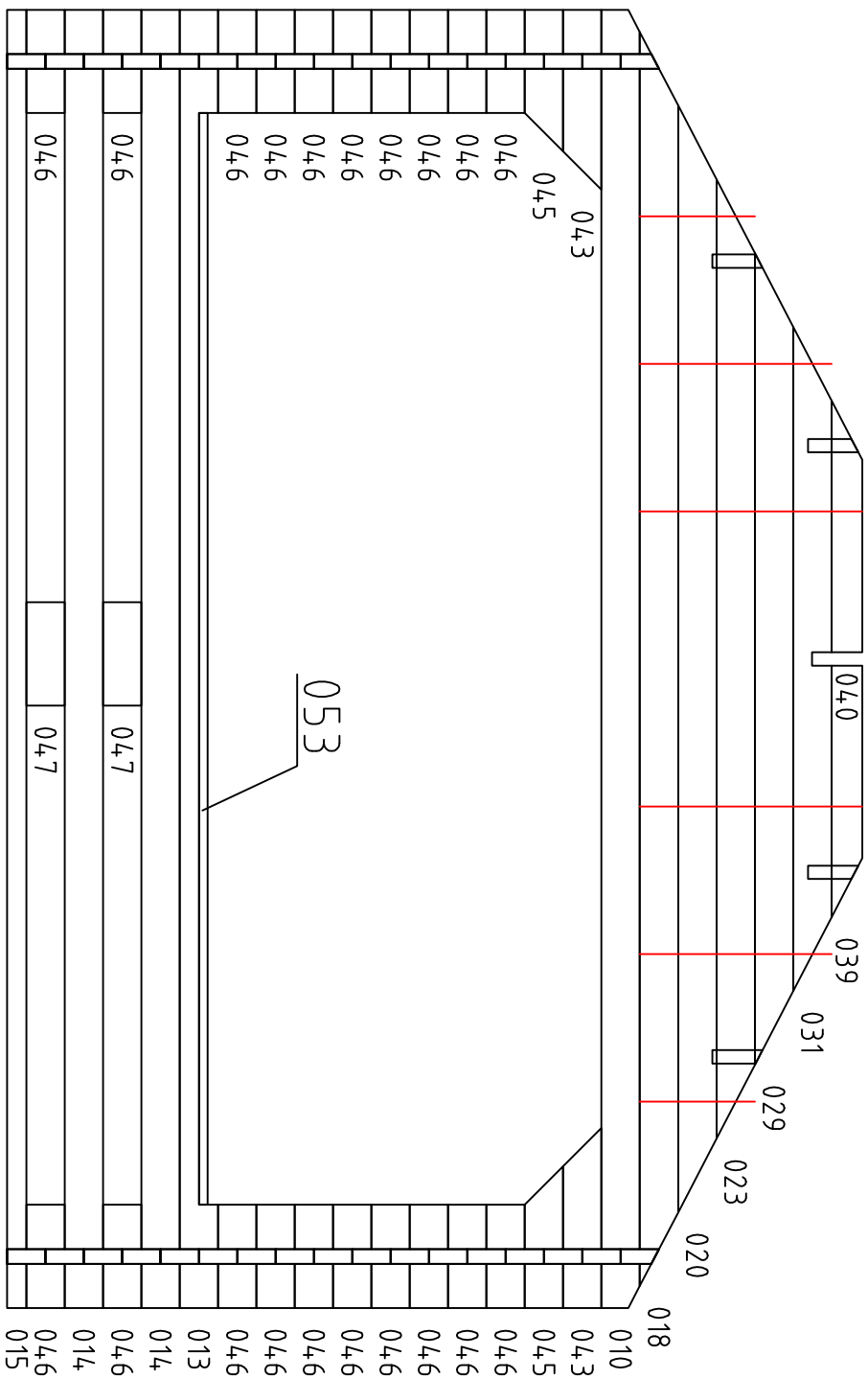

Wand D ↗

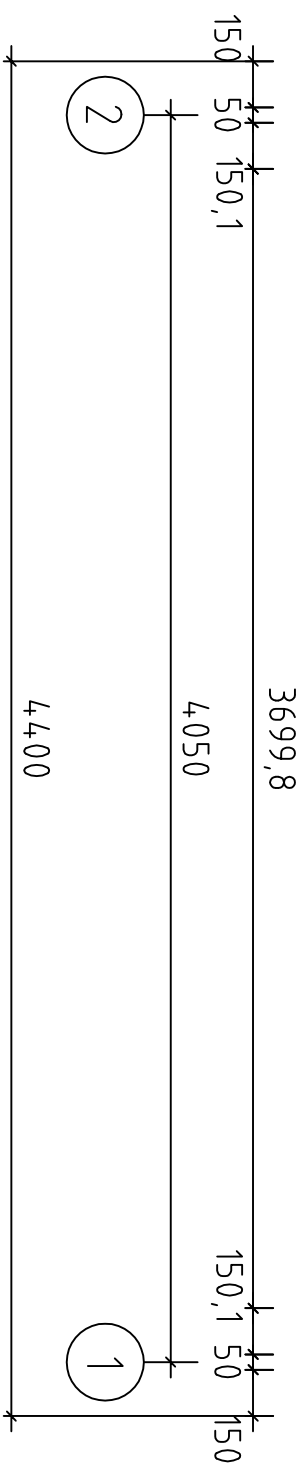

W 4x4 + 3 + A / 50 / 12

Wand 2 ↗

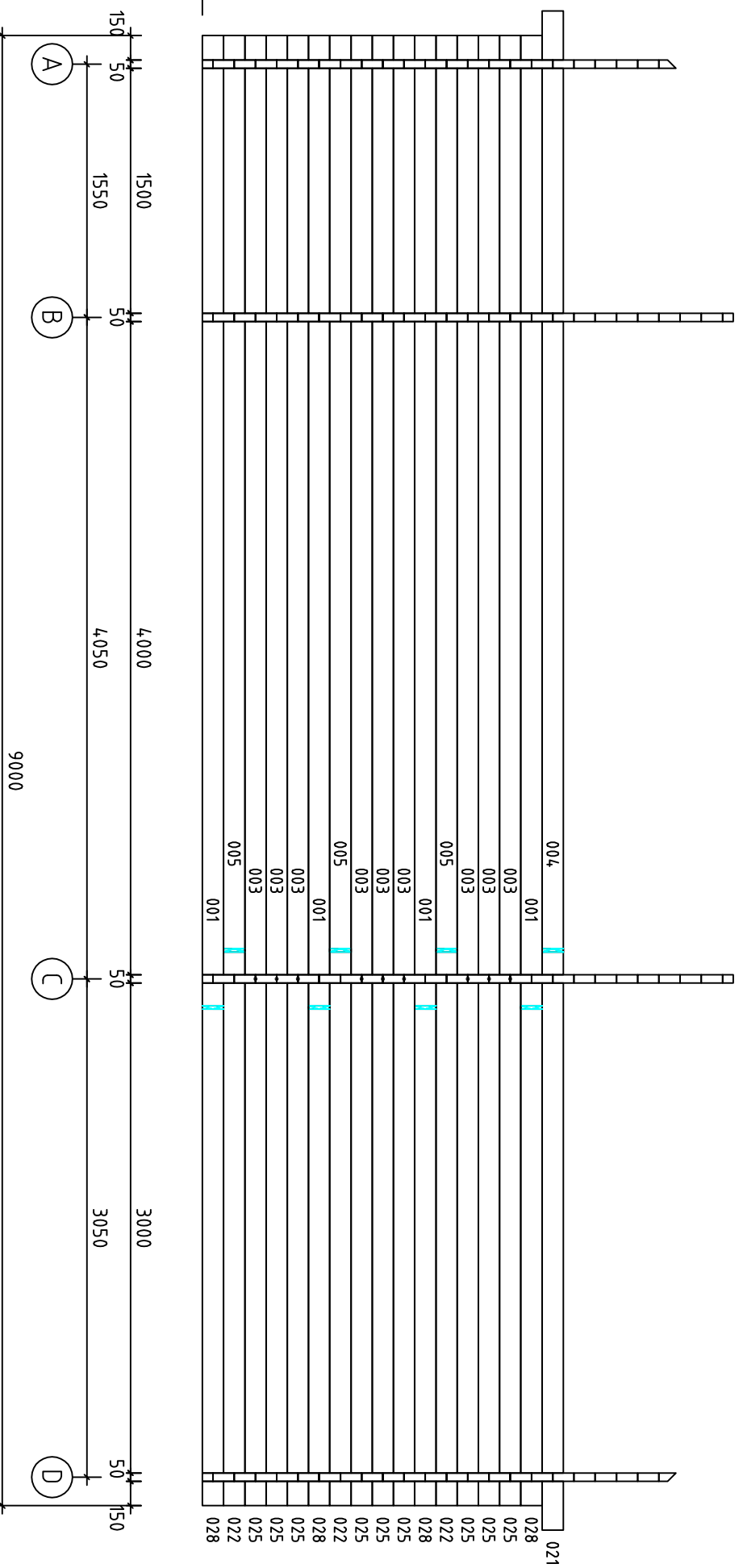

$$W 4 \times 4 + 3 + A / 50 / 12$$

W 4x4+3+A / 50 / 12

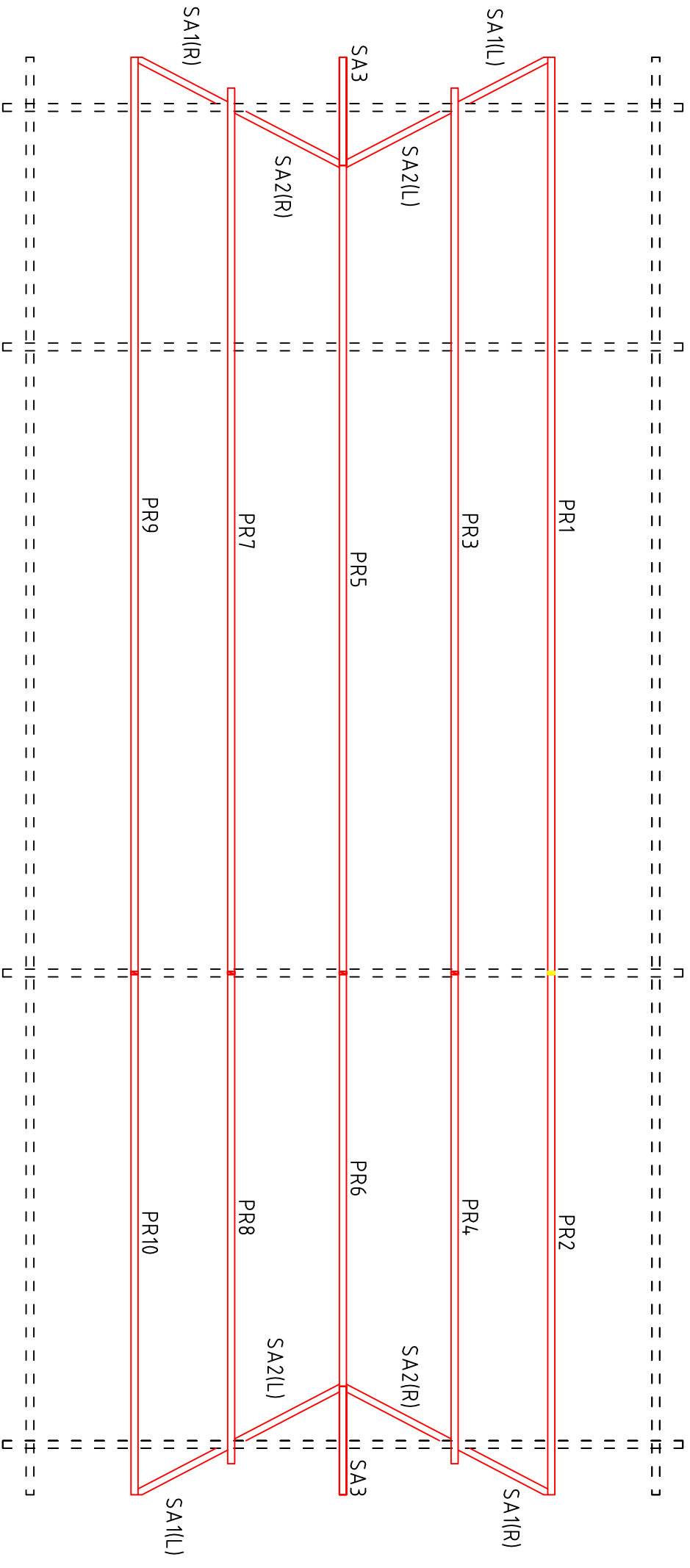

Dachbalken
Dakpalken
Roofbeam

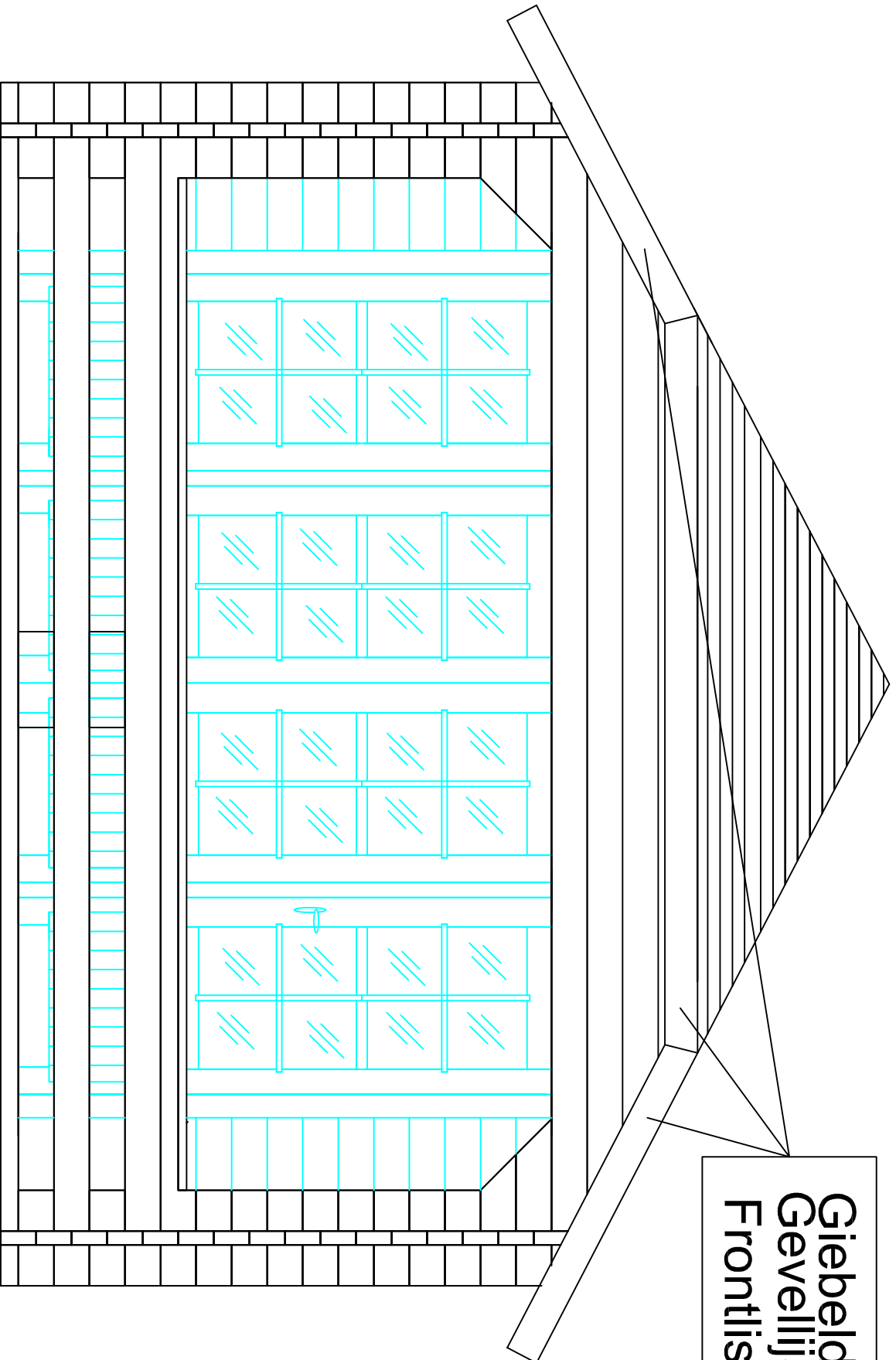

Giebeldeckleiste
Gevellist
Frontlist

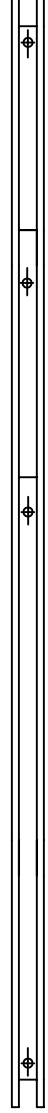
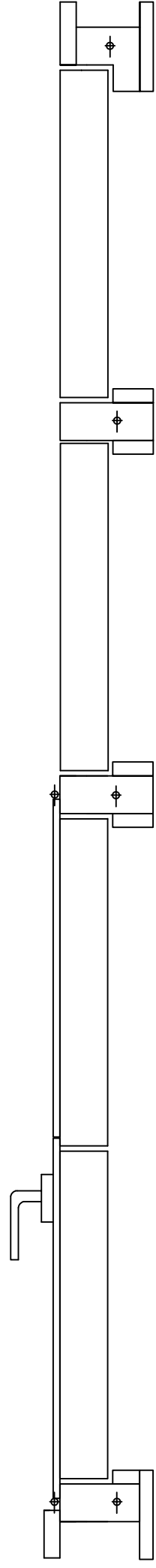
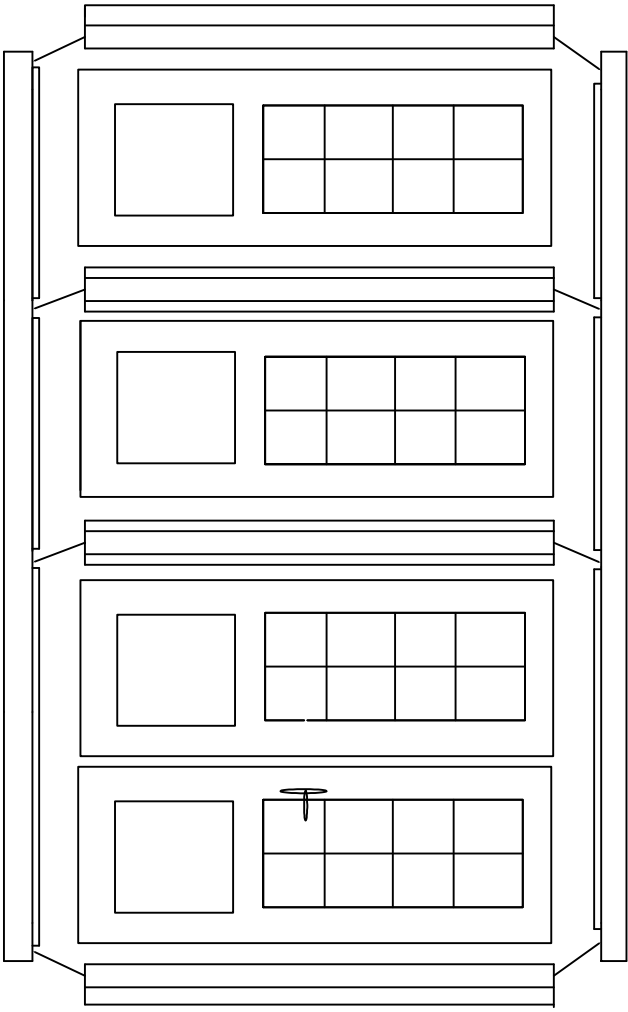

TÜR

6) Jetzt befestigen Sie mit spez. Winkeln schrägeren Pfetten SA1 ja SA2 an First- und Aussenpfetten mit Schrauben 3x40

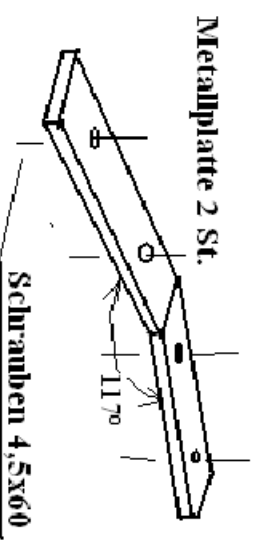
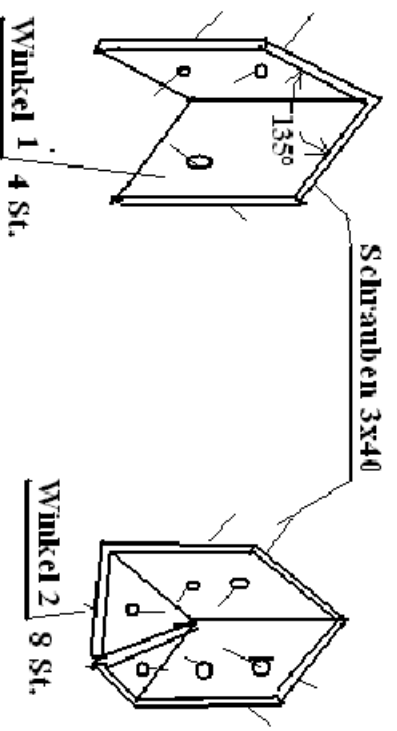
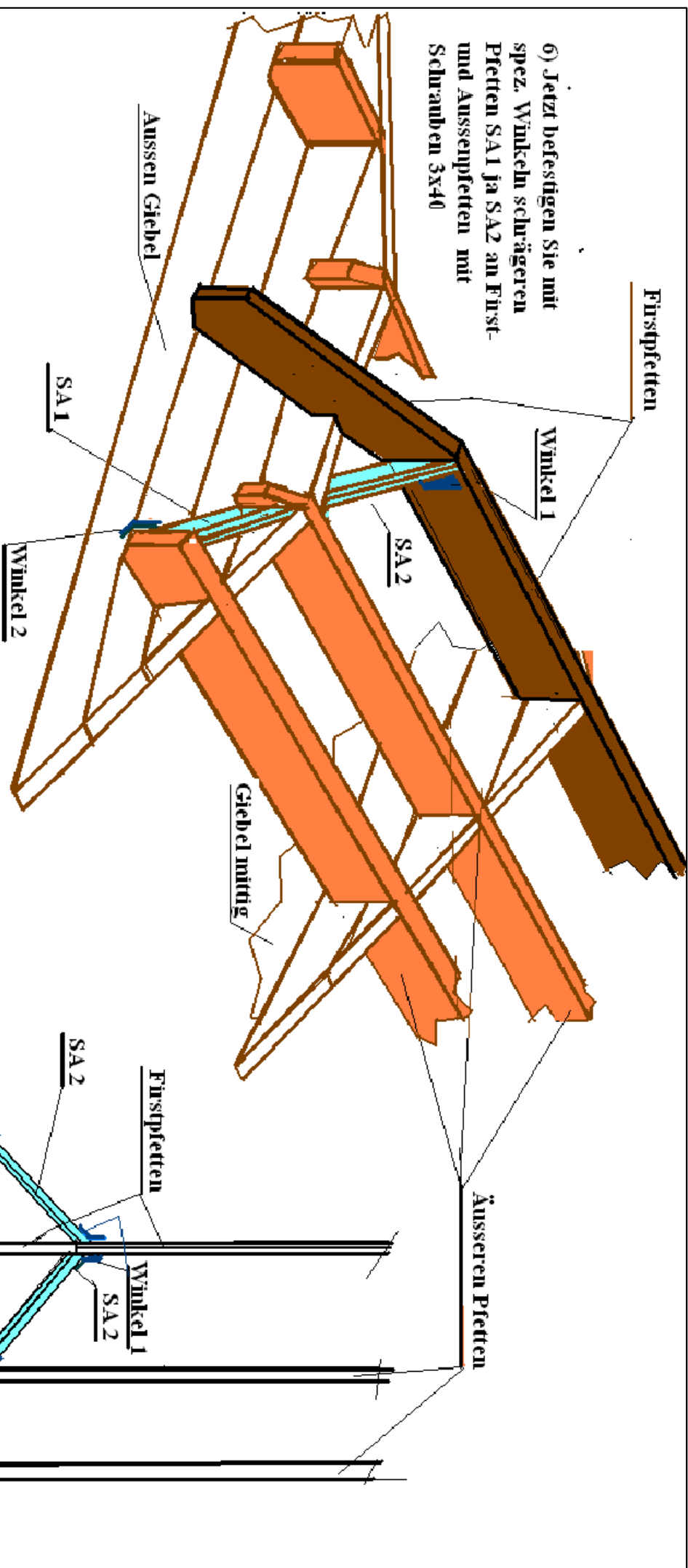

Häuser Serie "W7"/50 Die Führung nach der Montage der Pfetten.

- 1) Stellen Sie auf die feste Gründung die erste Reihe Wandbohlen fest
- 2) Weiter die Wände nach der Zeichnung bis zum Giebeln aufzustellen. Die Giebeln gehören auch in die Wände.

- 3) Danach müssen Sie die Pfetten aufbauen. Zuerst montieren Sie Firstpfetten zusammen so, wie auf Zeichnung sehen:

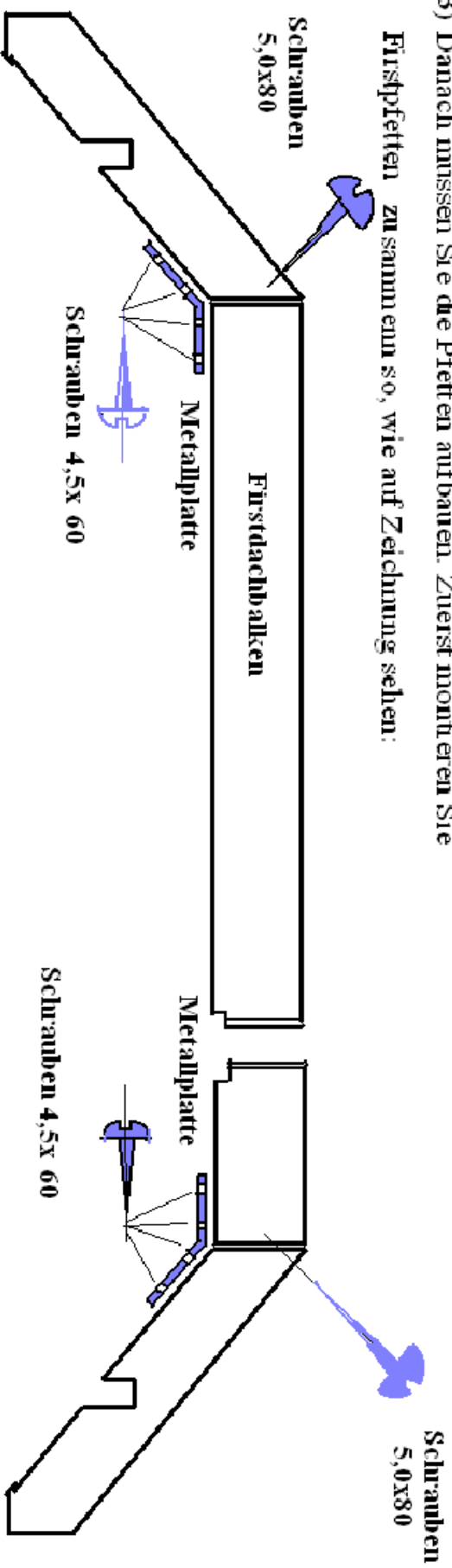



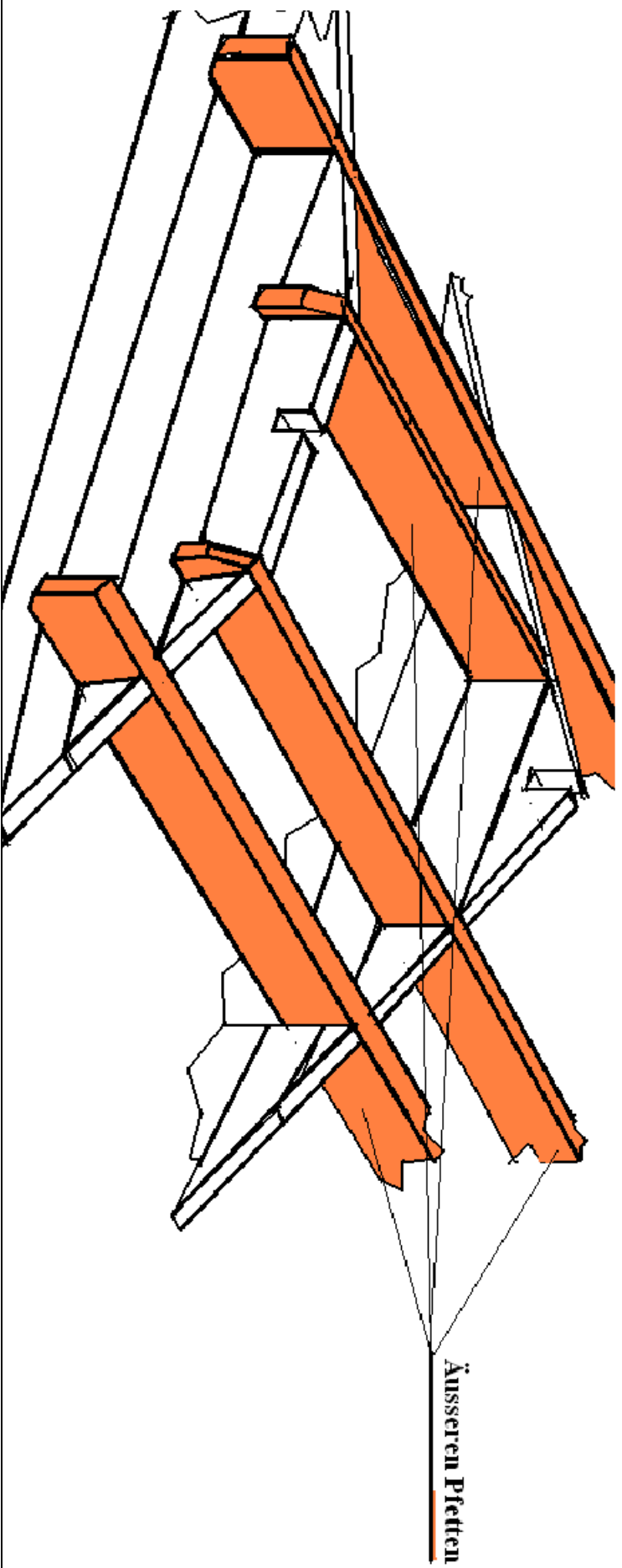

- 4) Versetzen Sie die äusseren Dachpfetten in Giebellöcher. Zwei Stk. links ja Zwei Stk. rechts

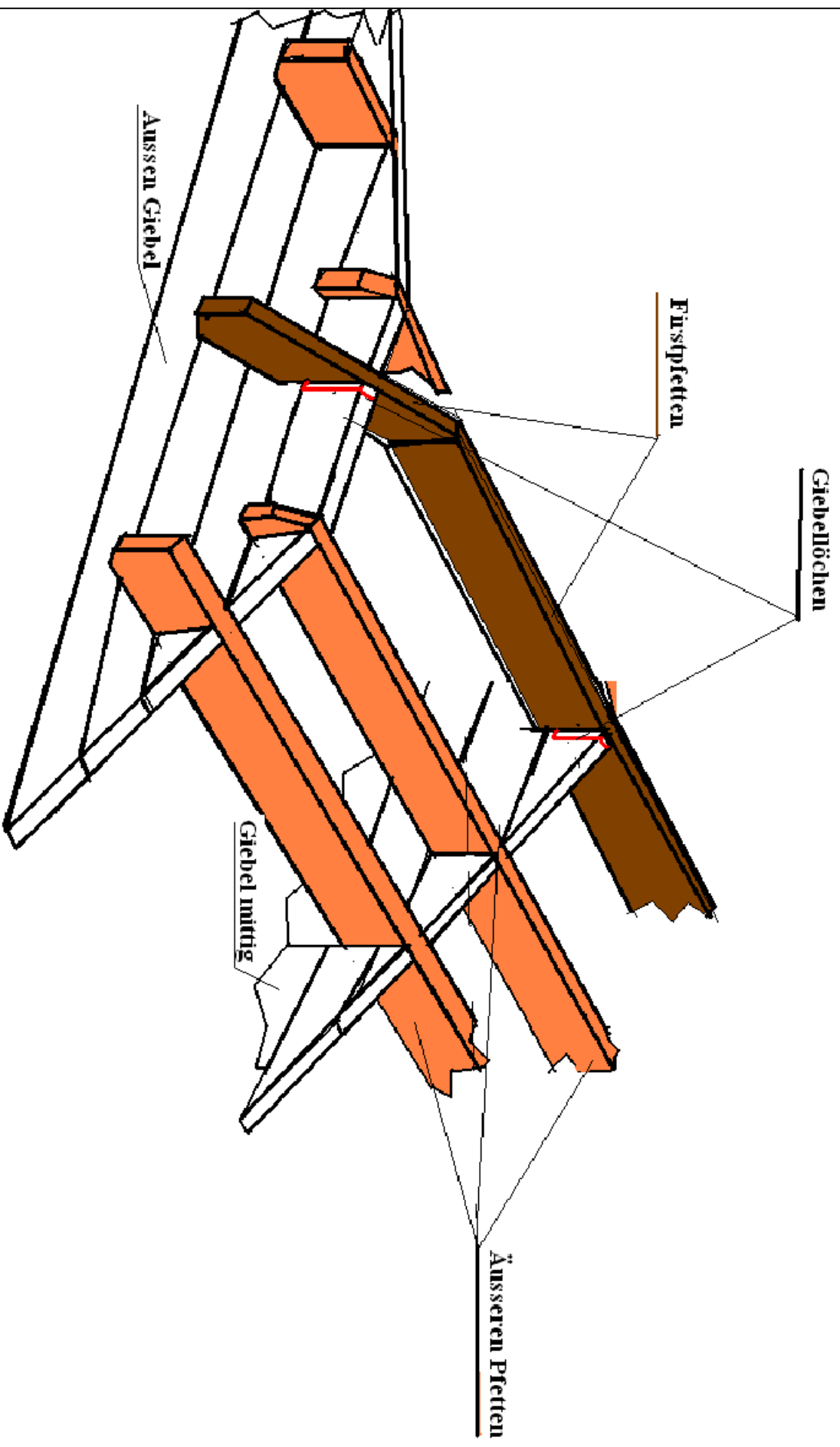

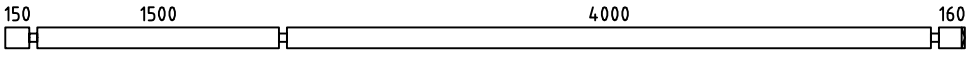
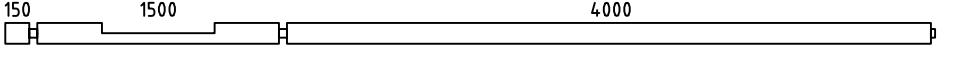
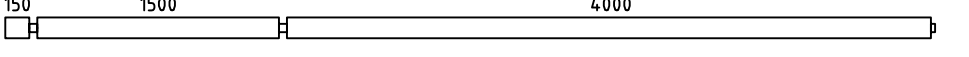
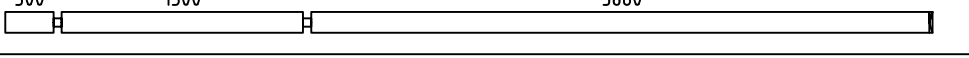
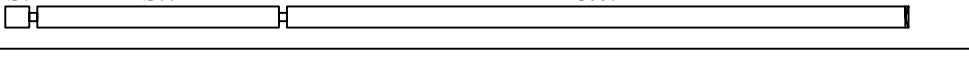
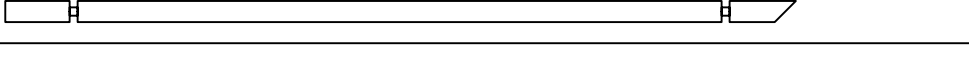
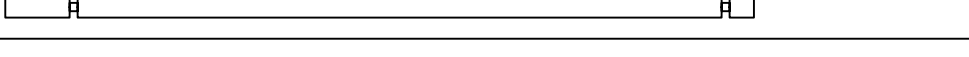
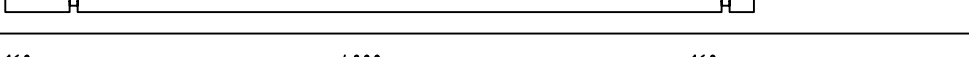
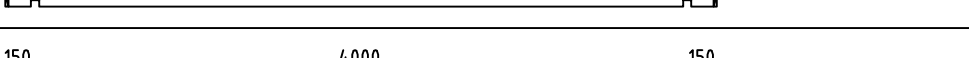
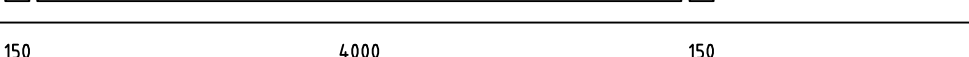
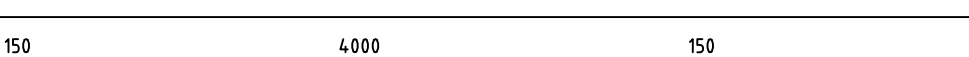
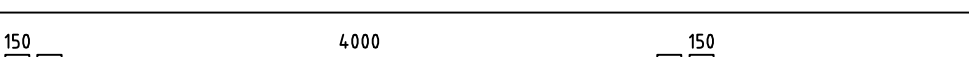
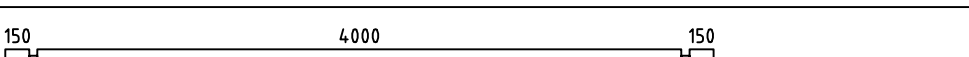
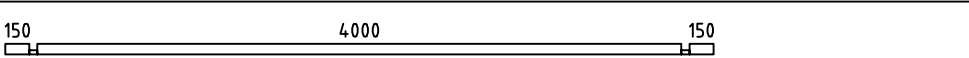
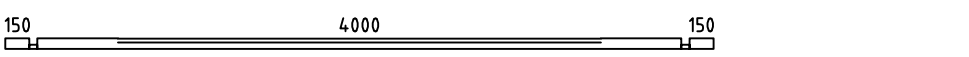
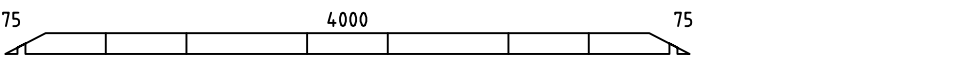
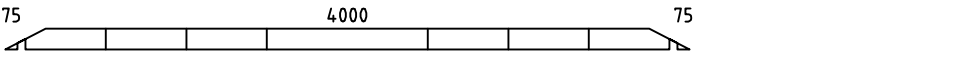
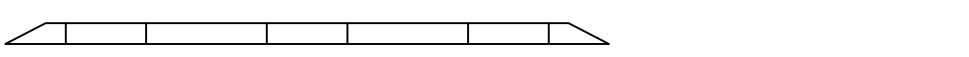
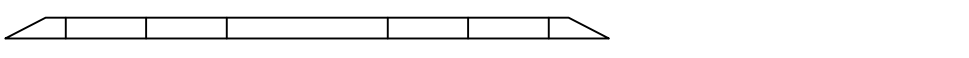
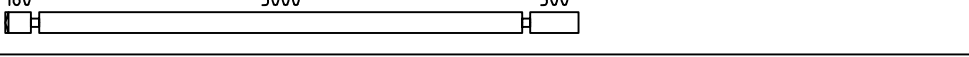
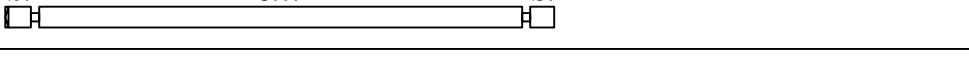
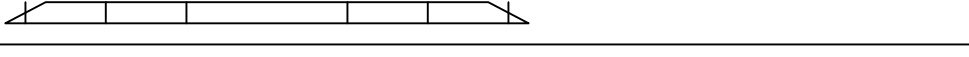
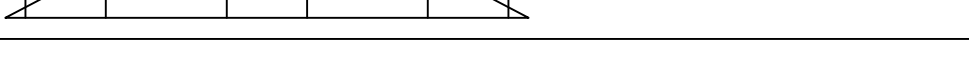
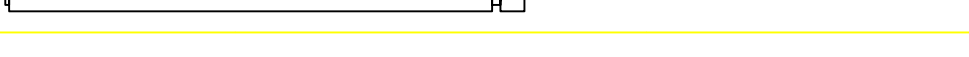

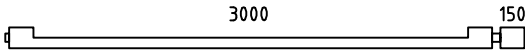
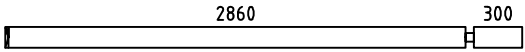
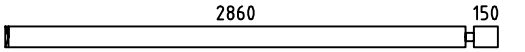
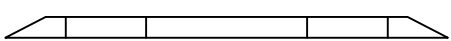
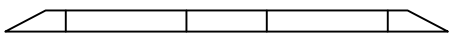
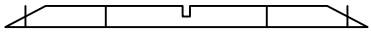
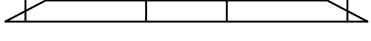
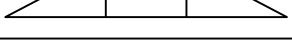
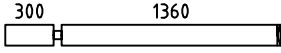
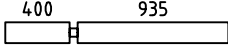
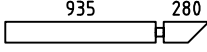
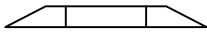
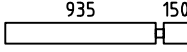
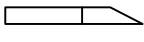
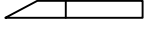
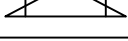
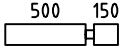
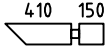
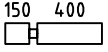



5) Jetzt müssen Sie **zusammenbefestigten Firstfetten in die Giebellöcher aufgehoben,**

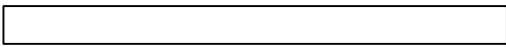
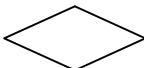

Pos	W 4x4+3+A / 50 / 12	ST	F (mm)	L (mm)
001		4	50x130	5960
002		1	50x130	5775
003		9	50x130	5775
004		1	50x130	5760
005		4	50x130	5610
006		1	50x130	4910
007		5	50x130	4650
008		1	50x130	4650
009		1	50x130	4420
010		2	50x130	4400
011		1	50x130	4400
012		1	50x130	4400
013		1	50x130	4400
014		32	50x130	4400
015		3	50x65	4400
016		1	50x65	4400
017		2	50x130	4250
018		2	50x130	4250
019		2	50x130	3750
020		2	50x130	3750
021		1	50x130	3560
022		4	50x130	3410
023		2	50x130	3250
024		2	50x130	3250
025		9	50x130	3225

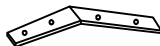
Pos	W 4x4+3+A / 50 / 12	ST	F (mm)	L (mm)
026		1	50x130	3225
027		1	50x130	3210
028		4	50x130	3060
029		2	50x130	2750
030		2	50x130	2750
031		2	50x130	2250
032		2	50x130	2250
033		2	50x130	1750
034		1	50x130	1710
035		7	50x130	1385
036		1	50x130	1265
037		2	50x130	1250
038		6	50x130	1135
039		2	50x104	853
040		2	50x104	852
041		2	50x130	750
042		30	50x130	700
043		3	50x130	610
044		14	50x130	600
045		3	50x130	480
046		32	50x130	350
047		2	50x130	350
048		2	50x65	250

Pos	W 4x4+3+A / 50 / 12			ST	F (mm)	L (mm)
SA1	Dakpalken	Dachbalken	Roofbeam		2R+2L	
SA2	Dakpalken	Dachbalken	Roofbeam		2R+2L	
SA3	Dakpalken	Dachbalken	Roofbeam	2	45x134	1076
PR9	300	1500	Dakpalken Dachbalken Roofbeam 4000	1	45x190	5935
PR1	300	1500	Dakpalken Dachbalken Roofbeam 4000	1	45x190	5935
PR7	100	1500	Dakpalken Dachbalken Roofbeam 4000	1	45x190	5735
PR3	100	1500	Dakpalken Dachbalken Roofbeam 4000	1	45x190	5735
PR5	1149		Dakpalken Dachbalken Roofbeam 4000	1	45x190	5234
PR2		3000	Dakpalken Dachbalken Roofbeam 300	1	45x190	3385
PR10		3000	Dakpalken Dachbalken Roofbeam 300	1	45x190	3385
PR8		3000	Dakpalken Dachbalken Roofbeam 100	1	45x190	3185
PR4		3000	Dakpalken Dachbalken Roofbeam 100	1	45x190	3185
PR6			Dakpalken Dachbalken Roofbeam	1	45x190	2684
049	Dachbrettern Dakplanken Roofboards			224	90x20	2650
050	Giebeldeckleiste Gevellijst Frontlist			4	120x20	3000
051	Giebelsegment Gevelsegment Frontsegment			2		
052	Dachpappenleiste Dakshingleslijst Fillet of cardboard			20	40x20	2000
053	Handlauf Afdekplank Handrail			1	90x20	3700
054	Abdeckleiste Afdekljst Finishinglist				40x20	16m
055	Dübel			132		
056	Metallplatte			2		
057	Winkel 1			4		
058	Winkel 2			8		
059	Schrauben	4,5x60=8st. 3,0x40=64 st.			kompl.	

