

4x4x2 / 50 / 2013

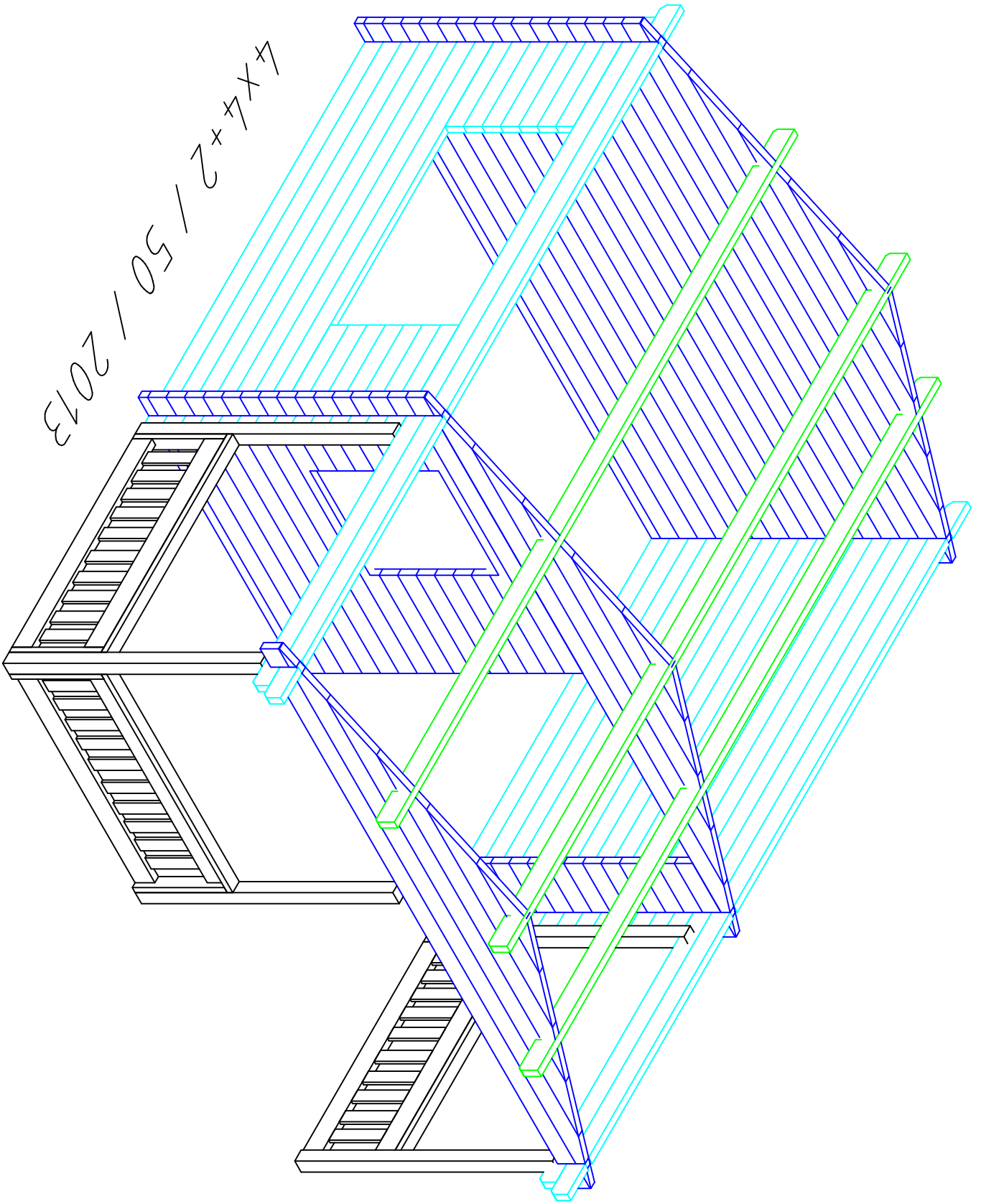

# 4x4+2 / 50 / 2013

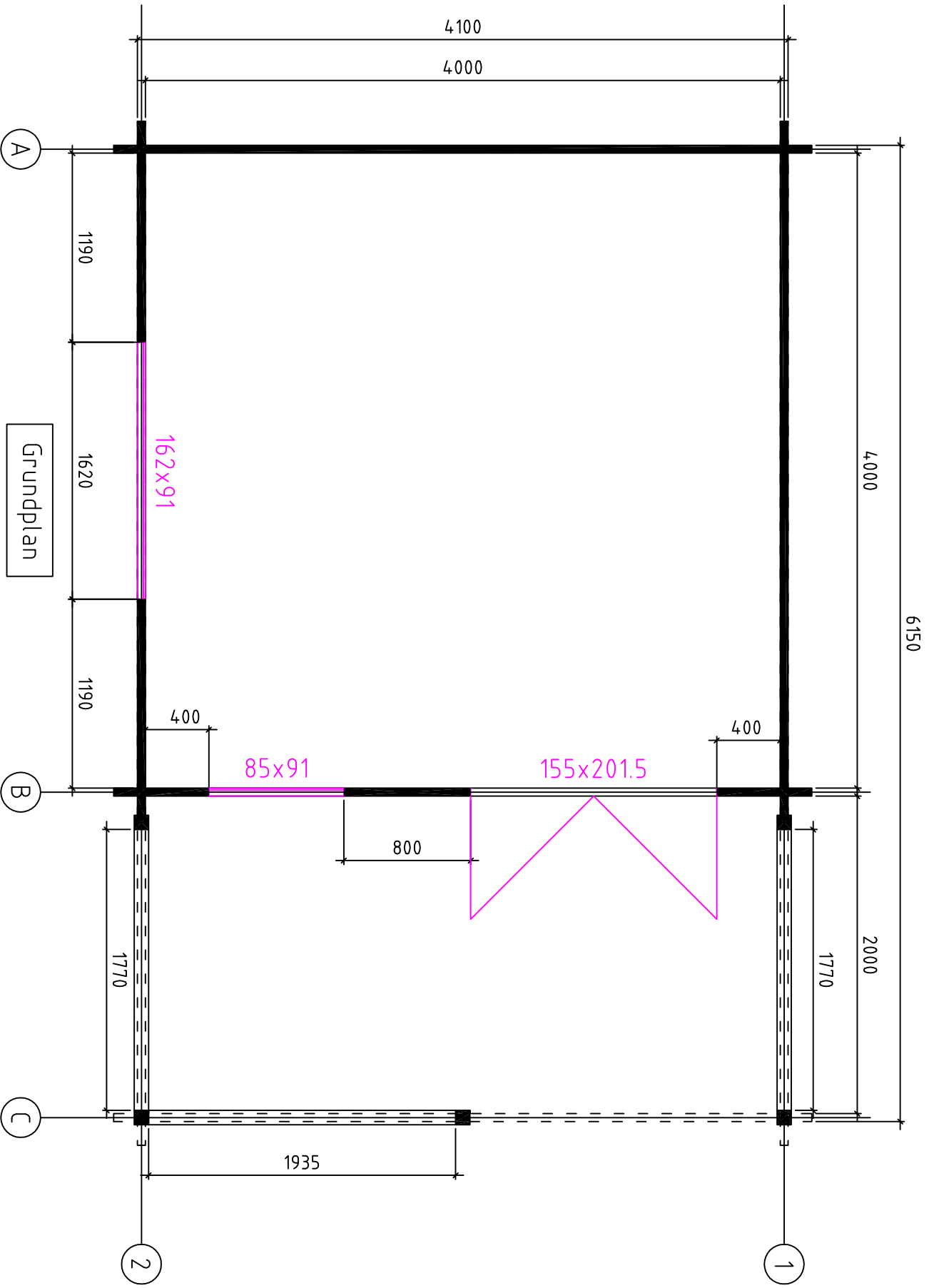

Wand 1 ↗

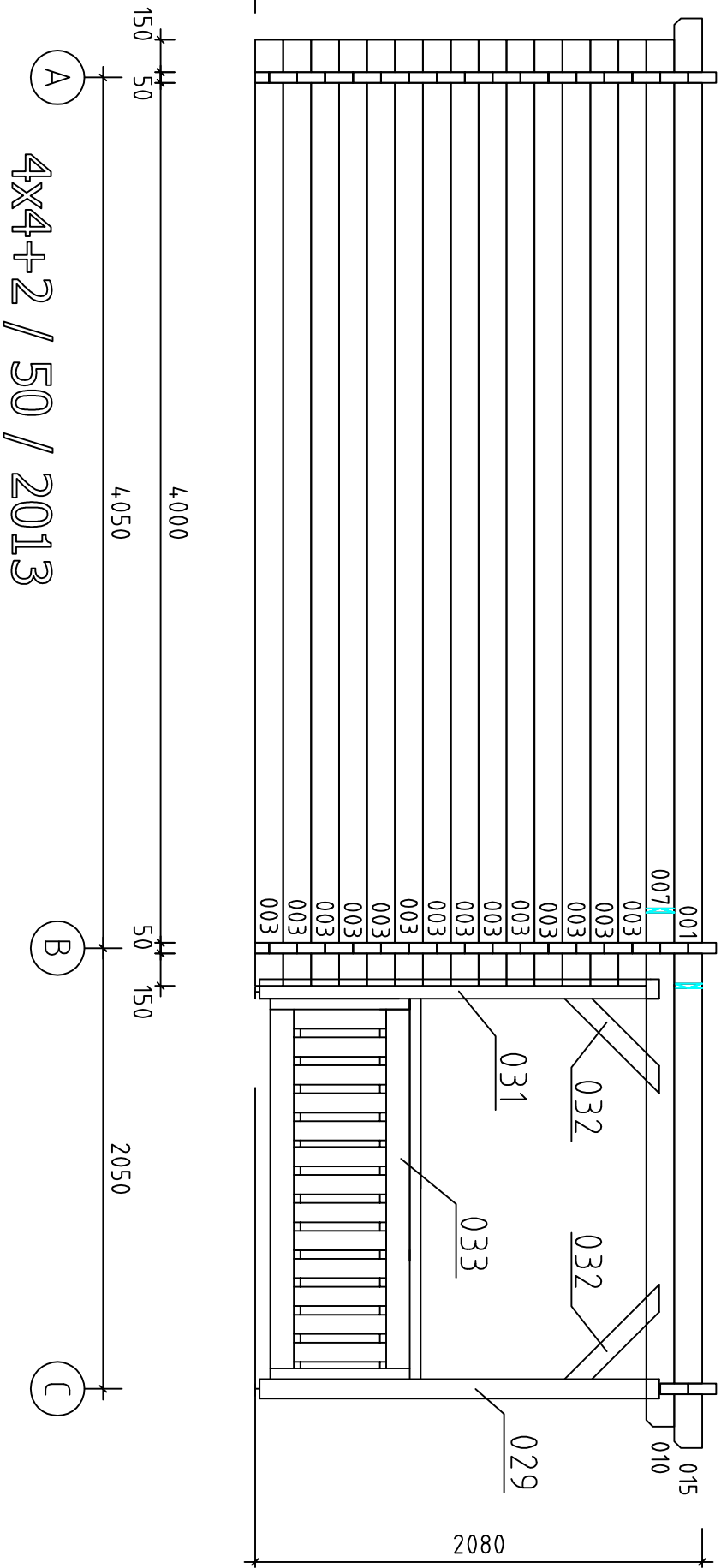

Wand 2 ↗

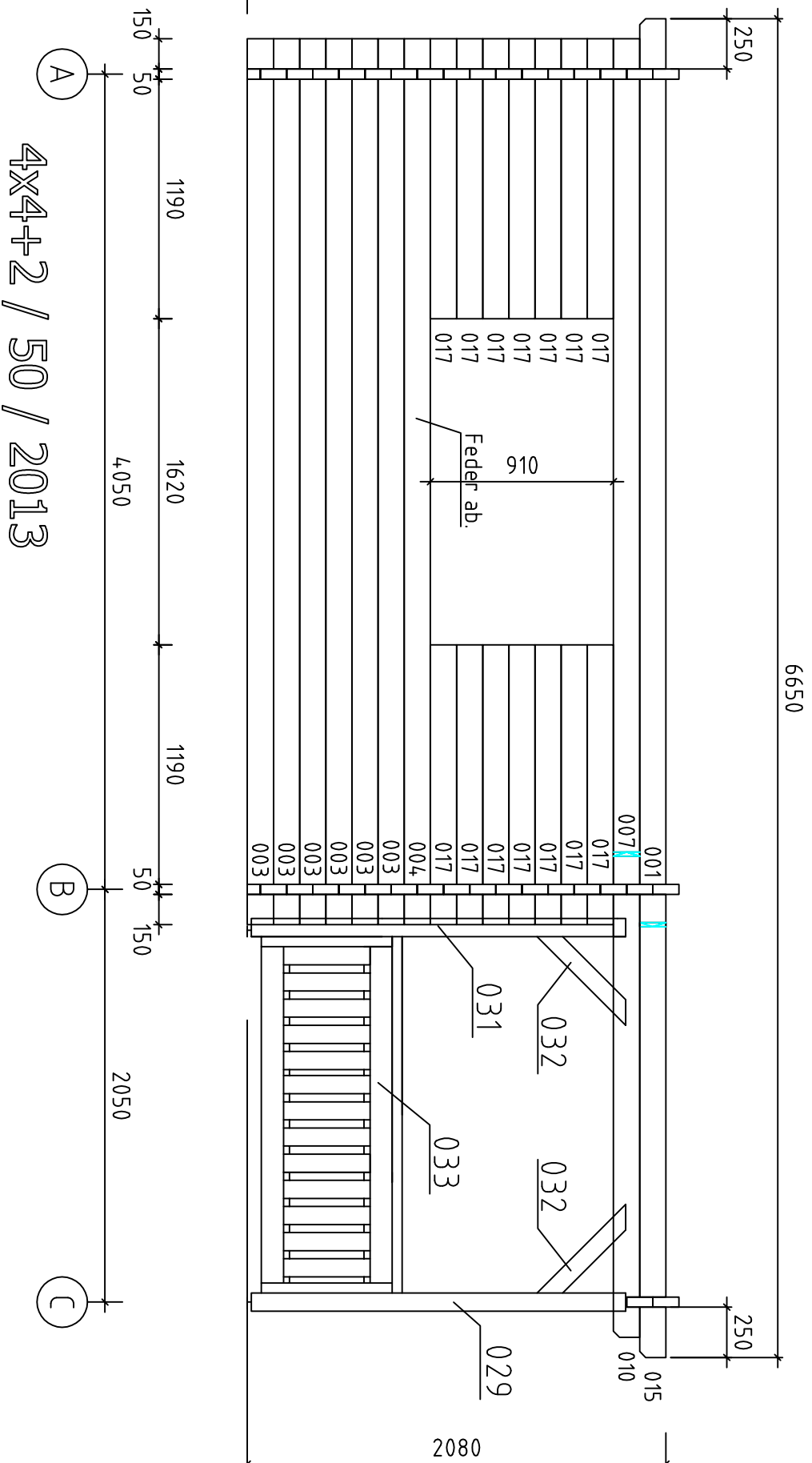

Scraubenloch  
vorbereiten !!!!!



Schrauben  
6x130

Wand A

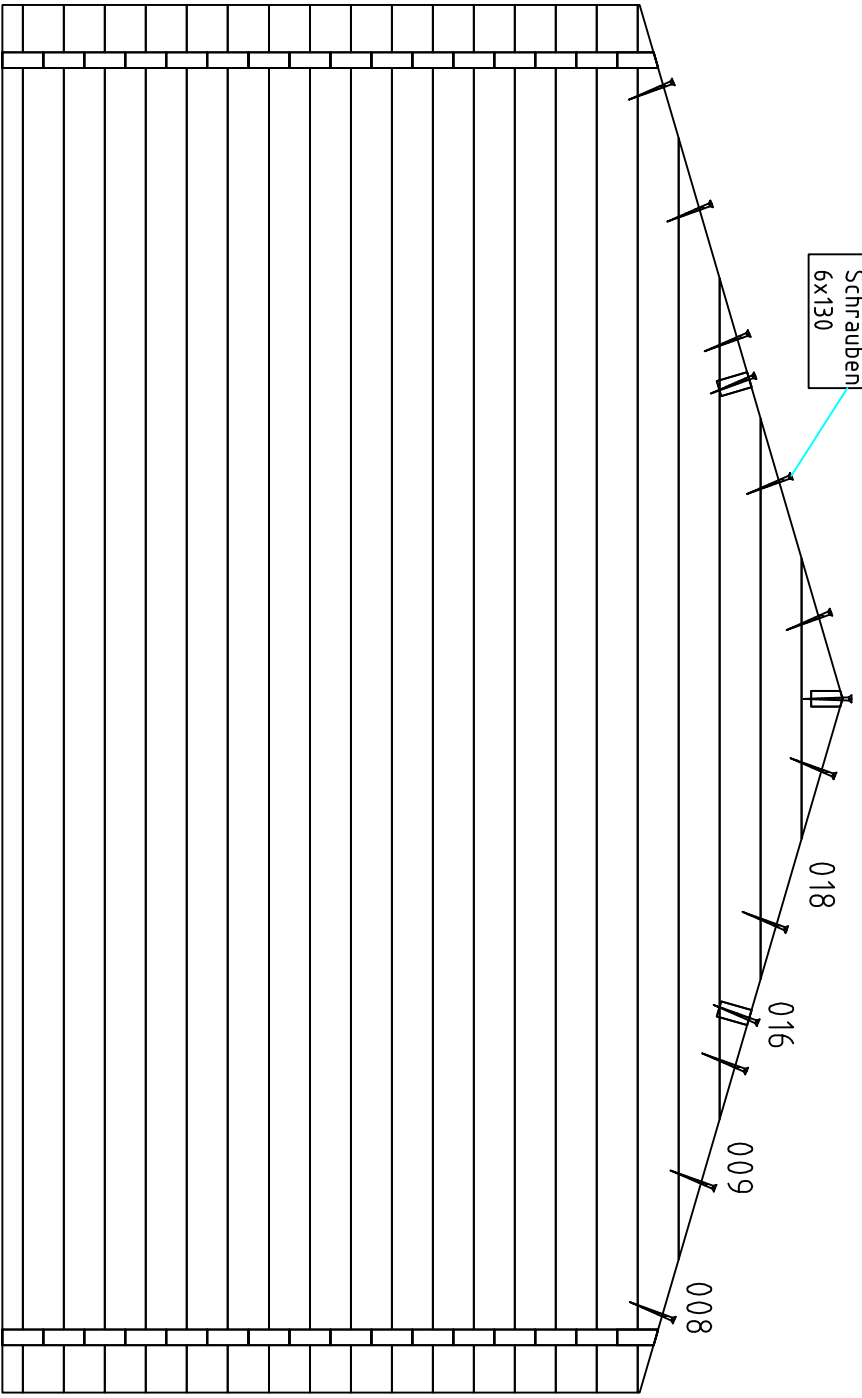

2

1

4X4+2 / 50 / 2013

2665

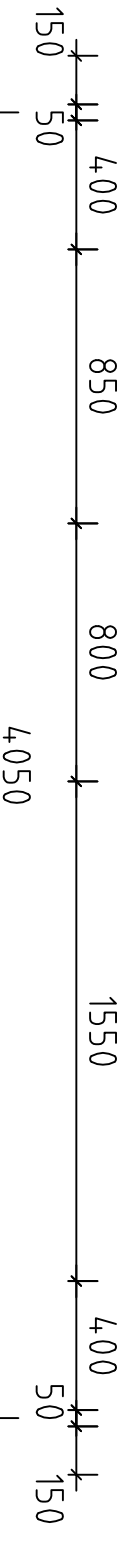
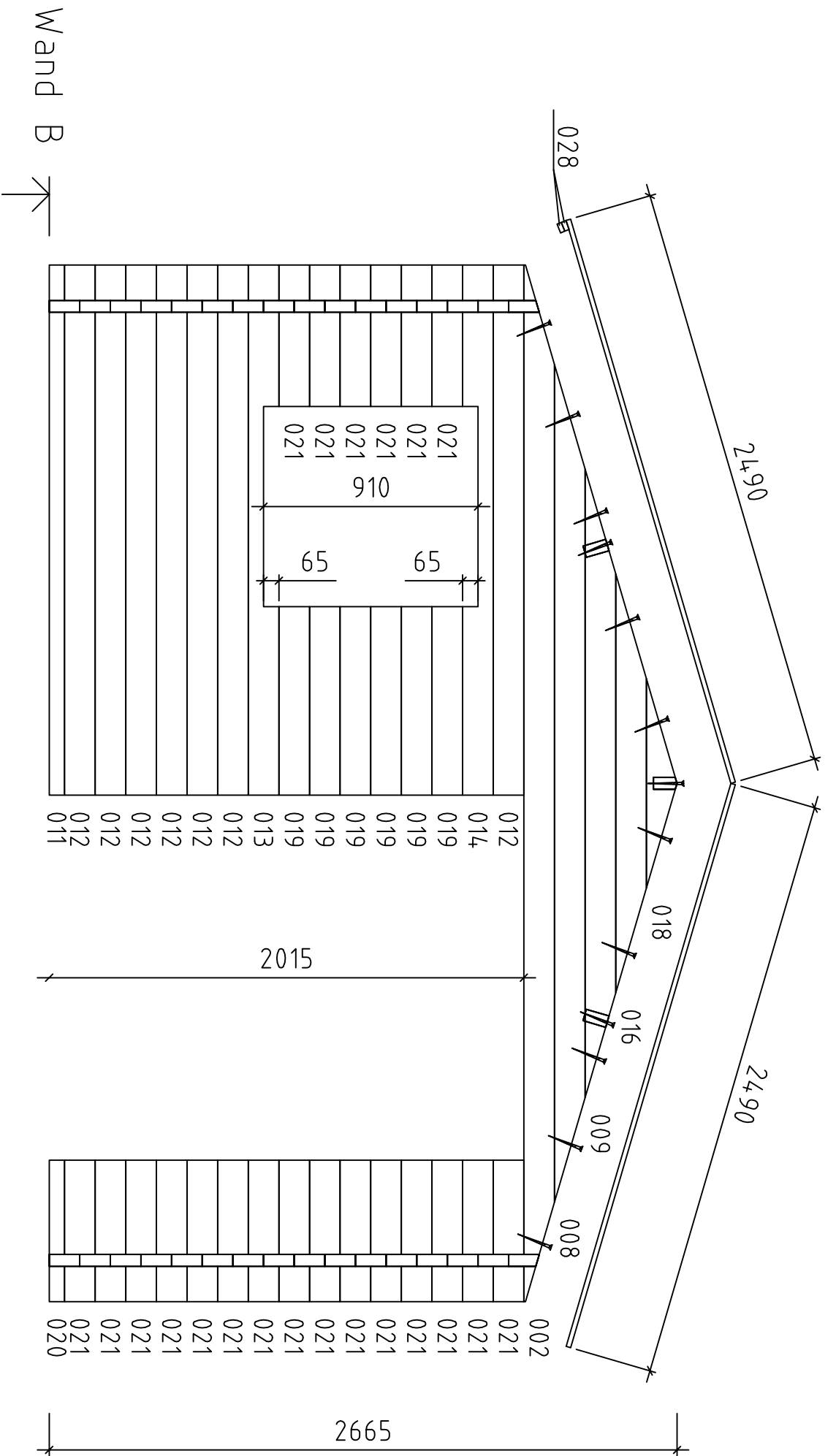

4X4+2 / 50 / 2013

2

1

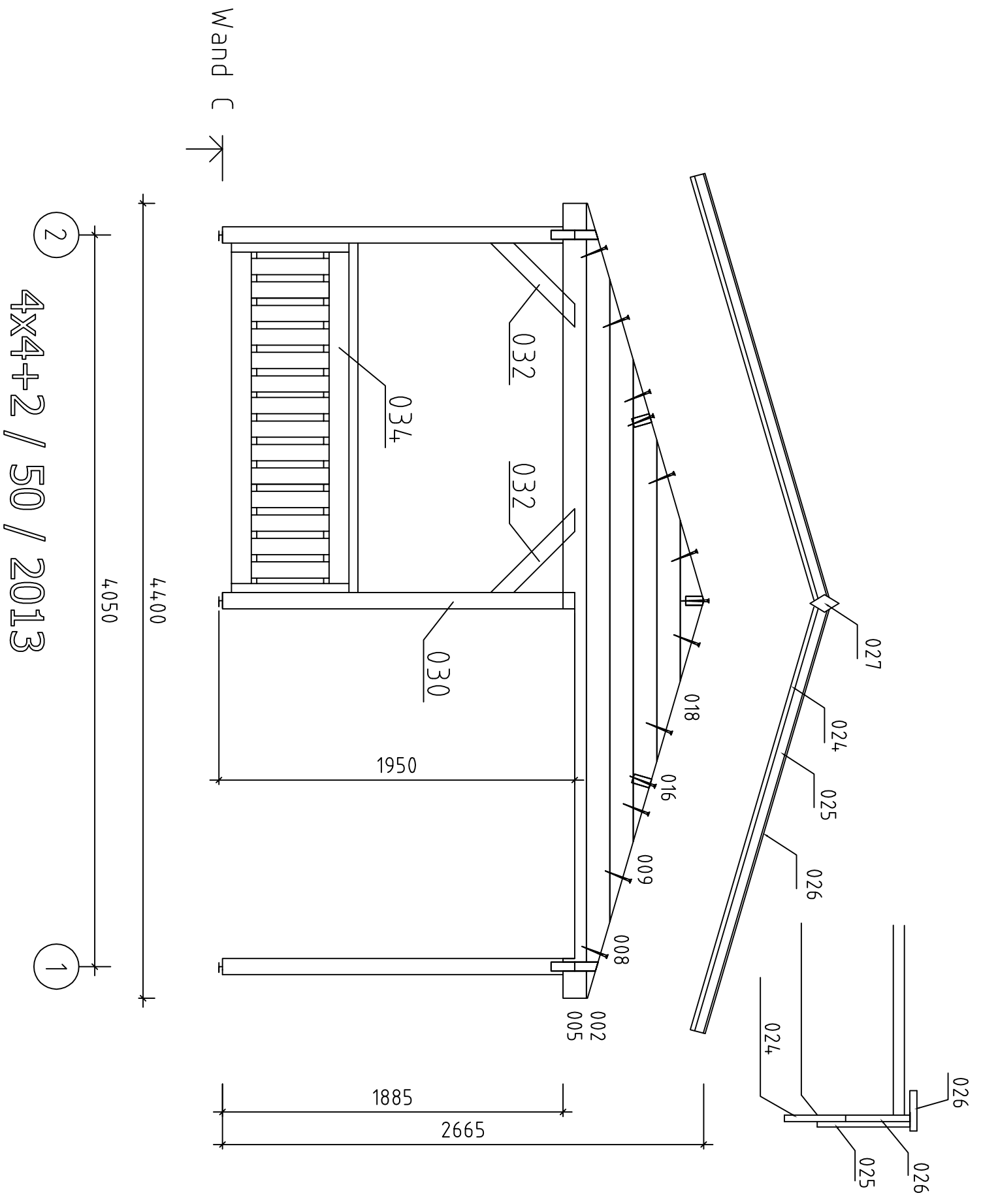

Wand C

2

4x4+2 / 50 / 2013

1

4400

4050

1950

1885

2665

032

032

034

030

002

005

008

009

016

018

027

024

025

026

026

025

026

024

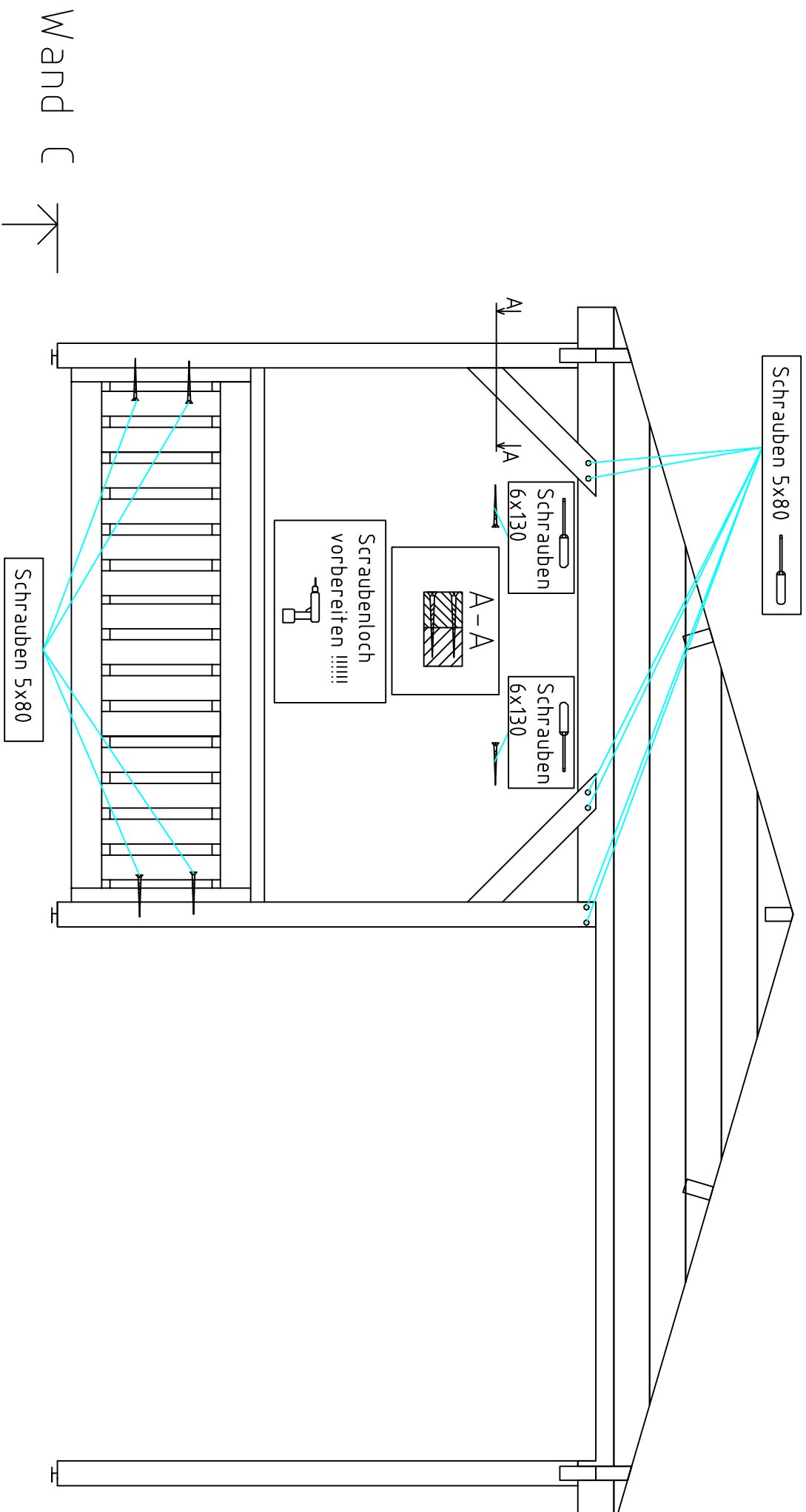

② 4x4+2 / 50 / 2013

①



Wand 1 ↗

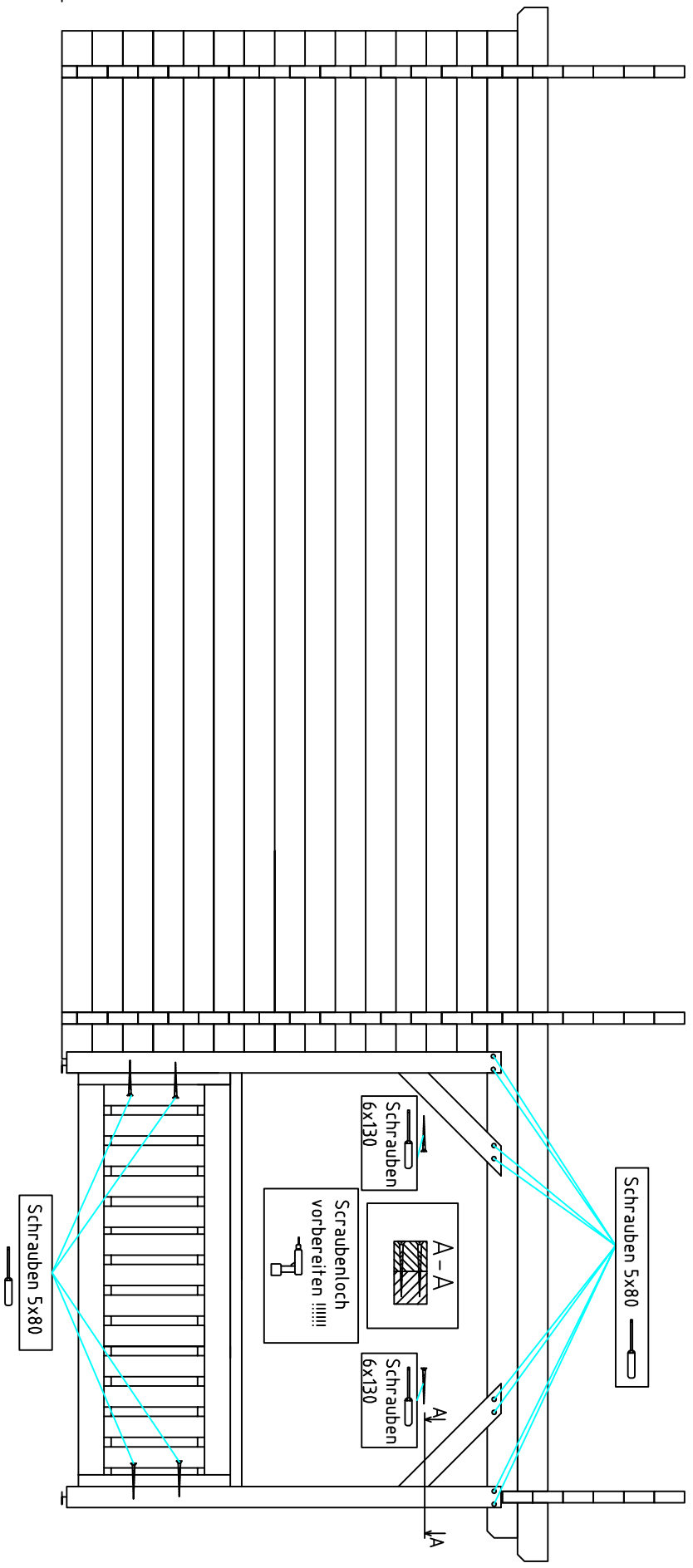

4050

2050

(A)

(B)

(C)

4x4+2 / 50 / 2013

Wand 2

A

4x4+2 / 50 / 2013

4050

B





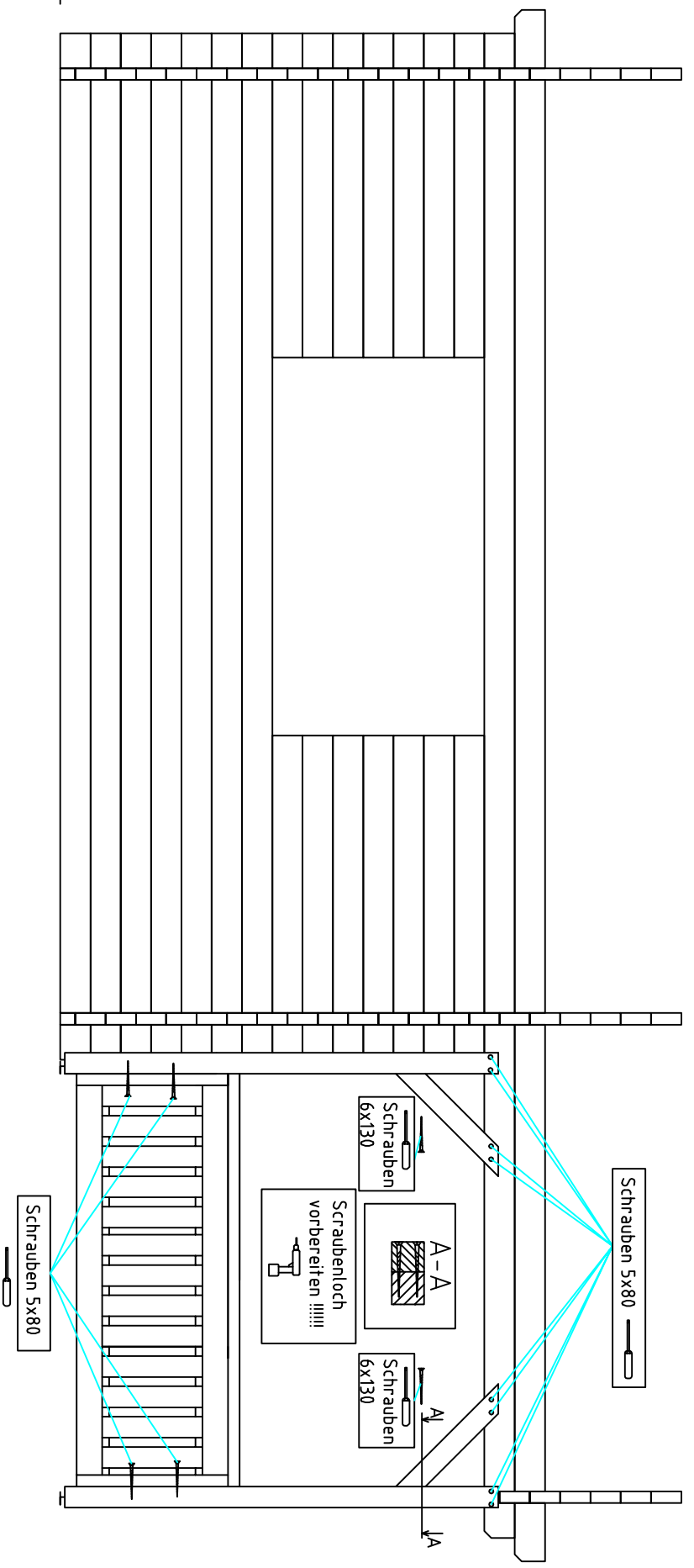

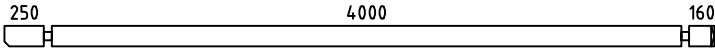
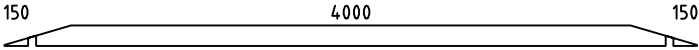
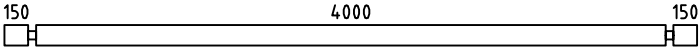
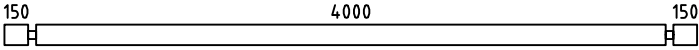
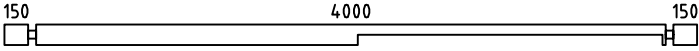
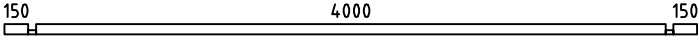
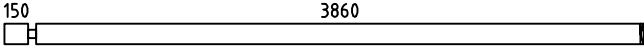
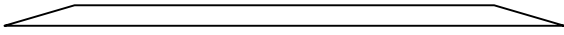
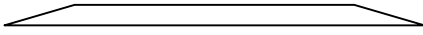
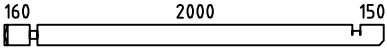
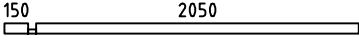
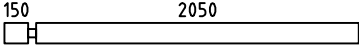
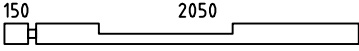
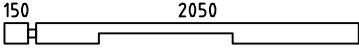
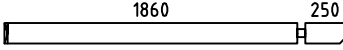
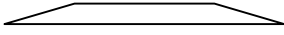
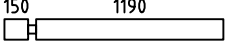
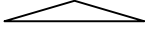
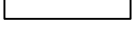
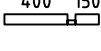
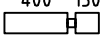



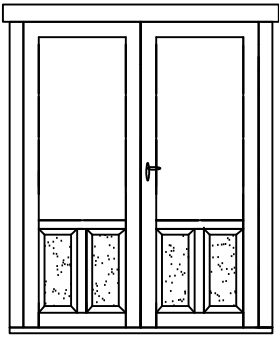
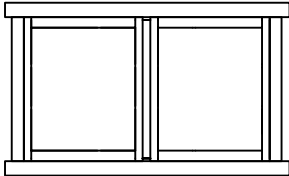
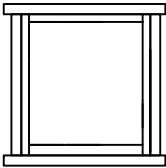

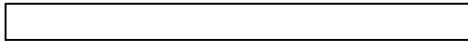
2050

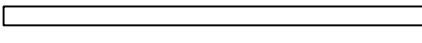
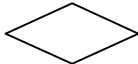
C

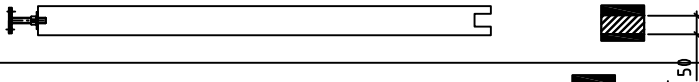
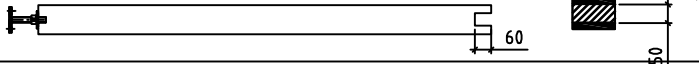

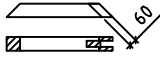
Pos	4x4+2 / 50 / 2013	ST	F (mm)	L (mm)
001		2	50x130	4510
002		3	50x130	4400
003		35	50x130	4400
004		1	50x130	4400
005		1	50x130	4400
006		1	50x65	4400
007		2	50x130	4060
008		3	50x130	3556
009		3	50x130	2667
010		2	50x130	2410
011		1	50x65	2250
012		7	50x130	2250
013		1	50x130	2250
014		1	50x130	2250
015		2	50x130	2160
016		3	50x130	1778
017		14	50x130	1390
018		3	50x130	889
019		6	50x130	800
020		1	50x65	600
021		21	50x130	600
Kood	Materjal	File	trükk.dwg	Leht 1/2

Pos	4x4+2 / 50 / 2013	ST	F (mm)	L (mm)
PR5	<p>Dachbalken 250 4035</p>	1	50x140	4335
PR3	<p>Dachbalken 250 4035</p>	1	50x140	4335
PR1	<p>Dachbalken 250 4035</p>	1	50x140	4335
PR2	<p>Dachbalken 2035 250</p>	1	50x140	2335
PR4	<p>Dachbalken 2035 250</p>	1	50x140	2335
PR6	<p>Dachbalken 2035 250</p>	1	50x140	2335
022	<p>Abdeckleiste Afdeklijs Finishinglist</p>		20x40	8m

Pos	4x4+2 / 50 / 2013		ST	F (mm)	L (mm)				
U155S	Tür 1550x2015 Deur Door		1						
		<table border="1"> <tr> <td>Iso</td> <td>1200x544= 2st.</td> </tr> <tr> <td></td> <td>kotike 1 kmpl.</td> </tr> </table>	Iso	1200x544= 2st.		kotike 1 kmpl.			
Iso	1200x544= 2st.								
	kotike 1 kmpl.								
F1	Fenster 1620x910 Raam Window		1						
		<table border="1"> <tr> <td>Iso</td> <td>629x657 2st.</td> </tr> </table>	Iso	629x657 2st.					
Iso	629x657 2st.								
F2	Fenster 850x910 Raam Window		1R						
		<table border="1"> <tr> <td>Iso</td> <td>629x657 1st.</td> </tr> </table>	Iso	629x657 1st.					
Iso	629x657 1st.								
023	Dachbrettern Dakplanken Roofboard's		150	90x20	2490				
024	Giebelleiste Gevelanderlijst Frontlist		4	120x20	2650				
025	Giebelleiste Gevelanderlijst Frontlist		4	90x20	2650				
026	Giebeldেকেলে Gevellijst Frontlist		8	60x20	2650				
027	Giebelsegment Gevelsegment Frontsegment		2						
028	Dachpappenleiste Dakshingleslijst Fillet of cardboard		12	40x20	2220				
029	Pfosten Kolom		2	90x90	1820				
030	Column		1	90x90	1880				
031			2	90x90	1820				
032	Träger		6	90x90	655				
033	Barriere		2		1770				
034			1		1935				
035	Schrauben		36	5,0x80					
036	Schrauben		57	6,0x130					
Kood	Materjal	File	trükk.dwg	Leht	2/2				

# Doppeltür

Beschlag:

Türklinken mit der Lasche = 1 Kmp.

Schraubeh 5x80mm = 4 St.

Schnepper mit Schlüsseln = 1 Kmp.

Metalblechen (zwei St.) Pos. 5,  
befinden sich auf untere oder  
obene Türflügelkante.

Schrauben 5x80

①

Schrauben 5x80

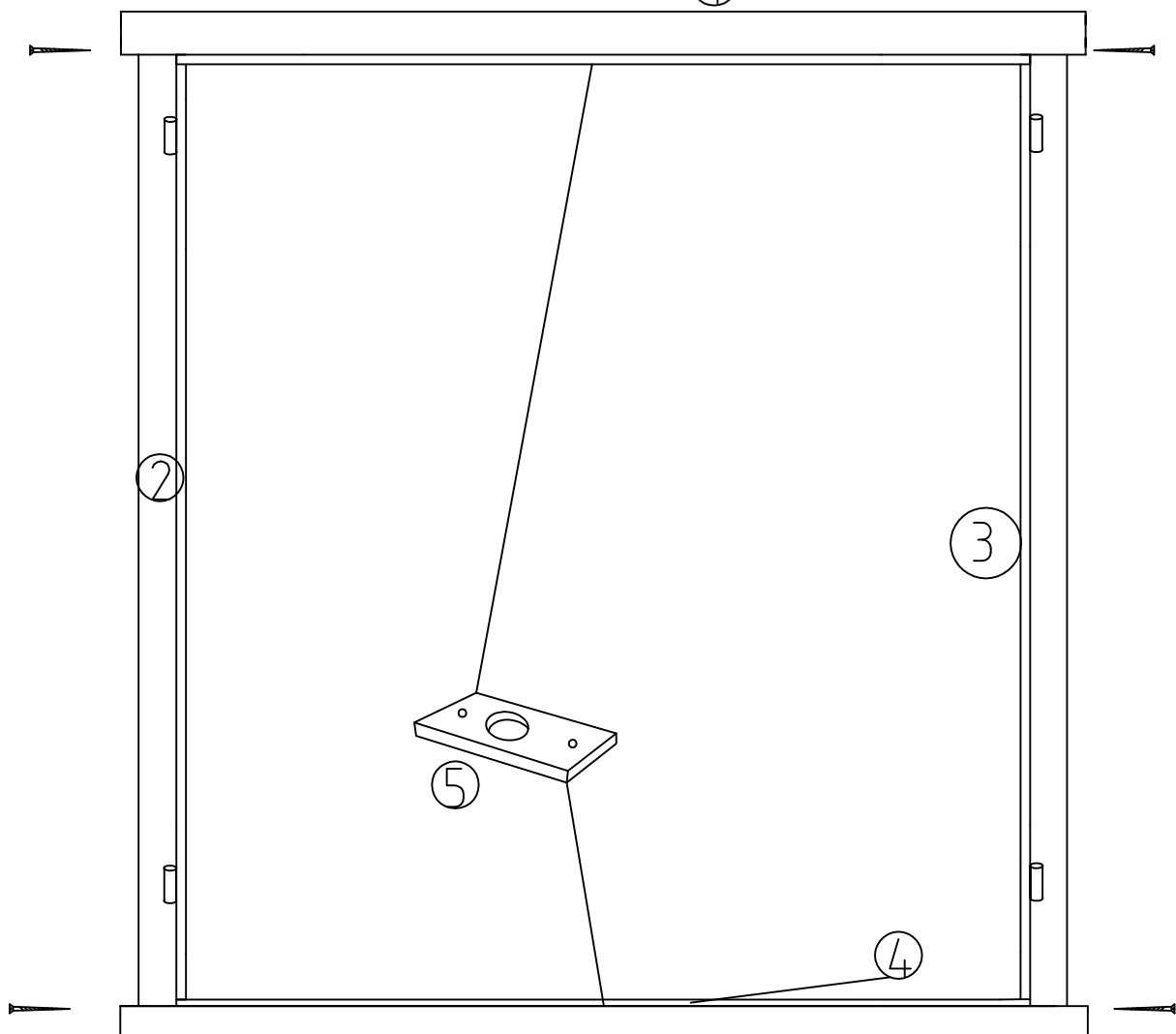

Schrauben 5x80

Schrauben 5x80