

5x5 / 50 / 2013

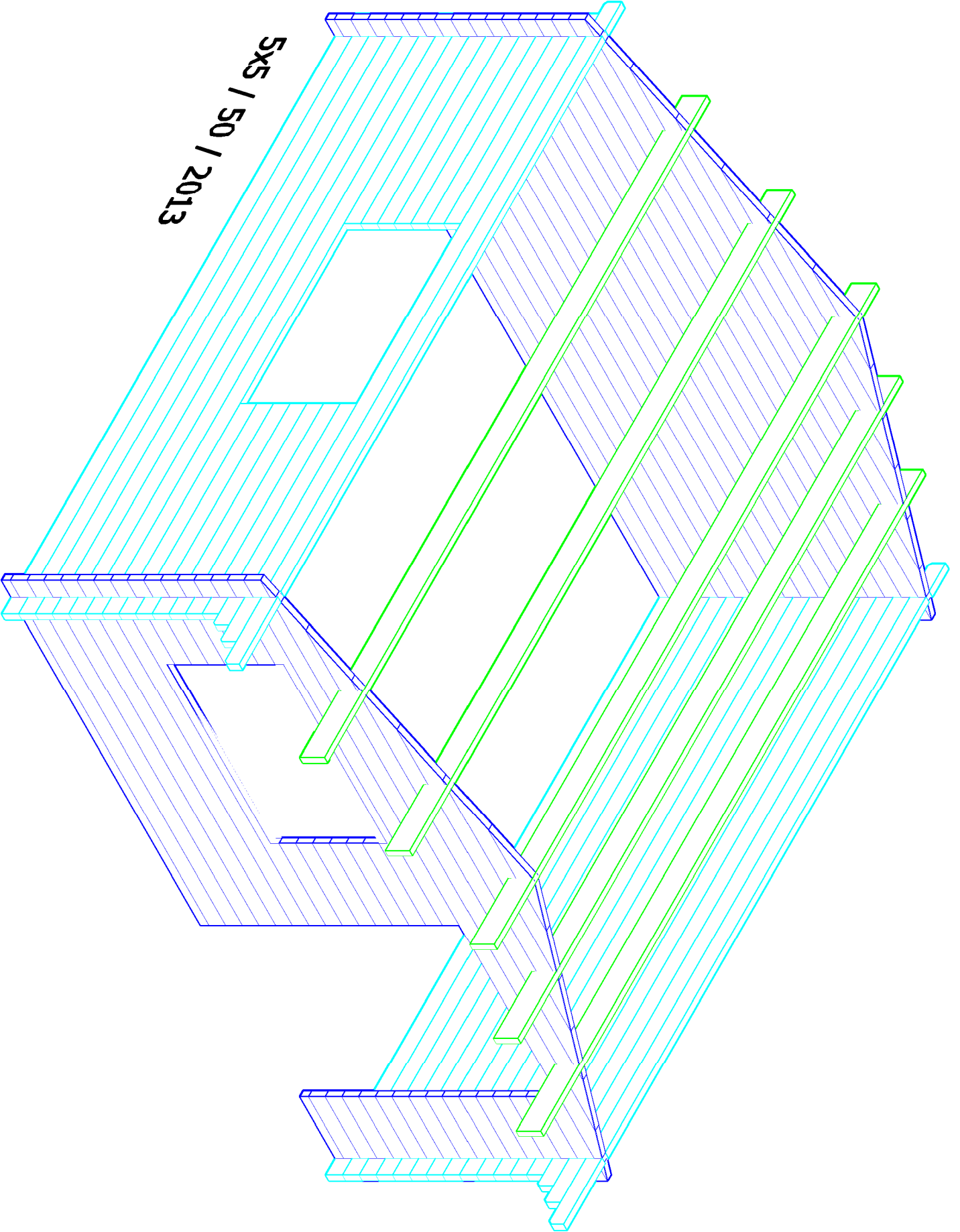

5x5 / 50 / 2013

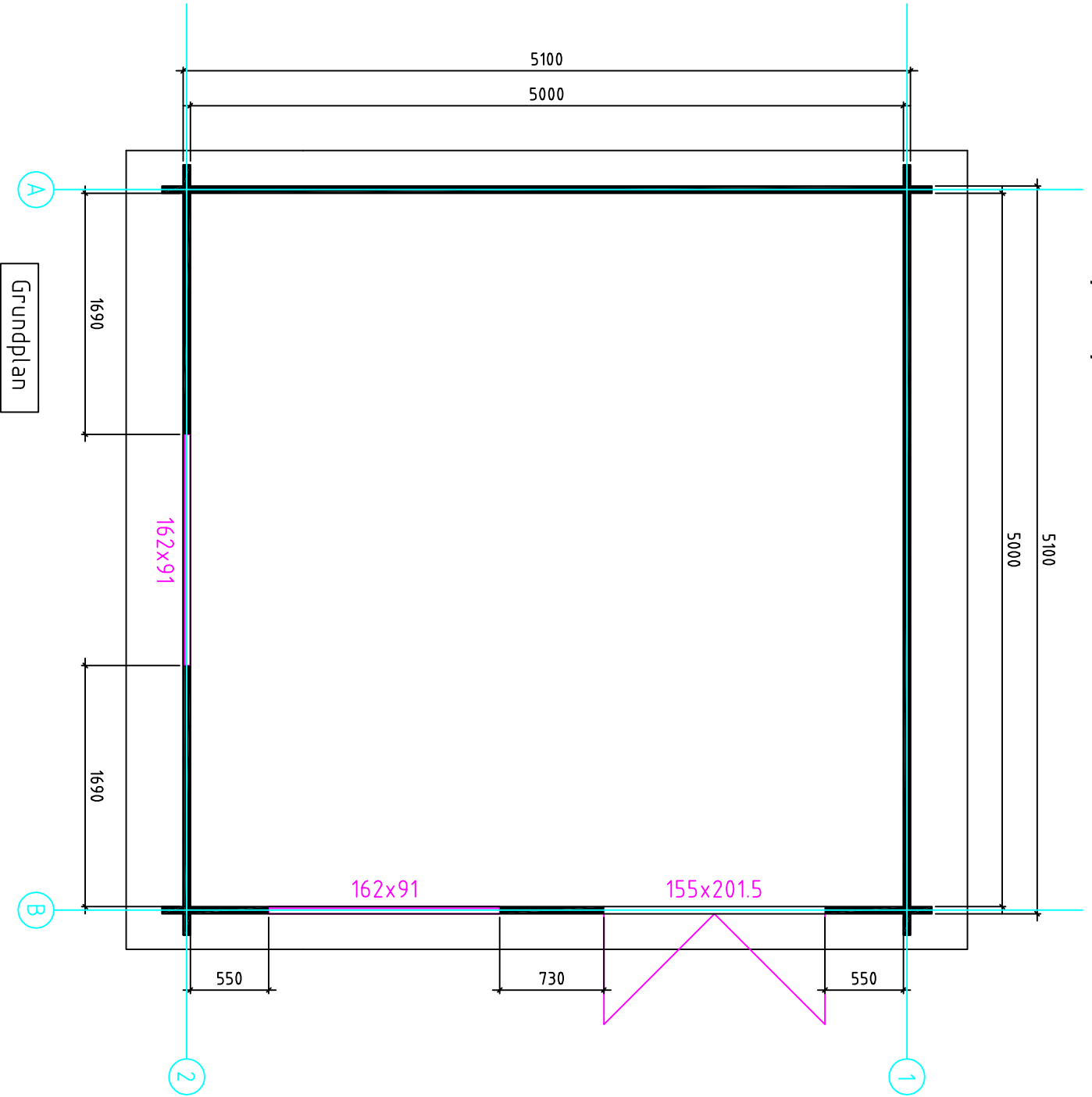

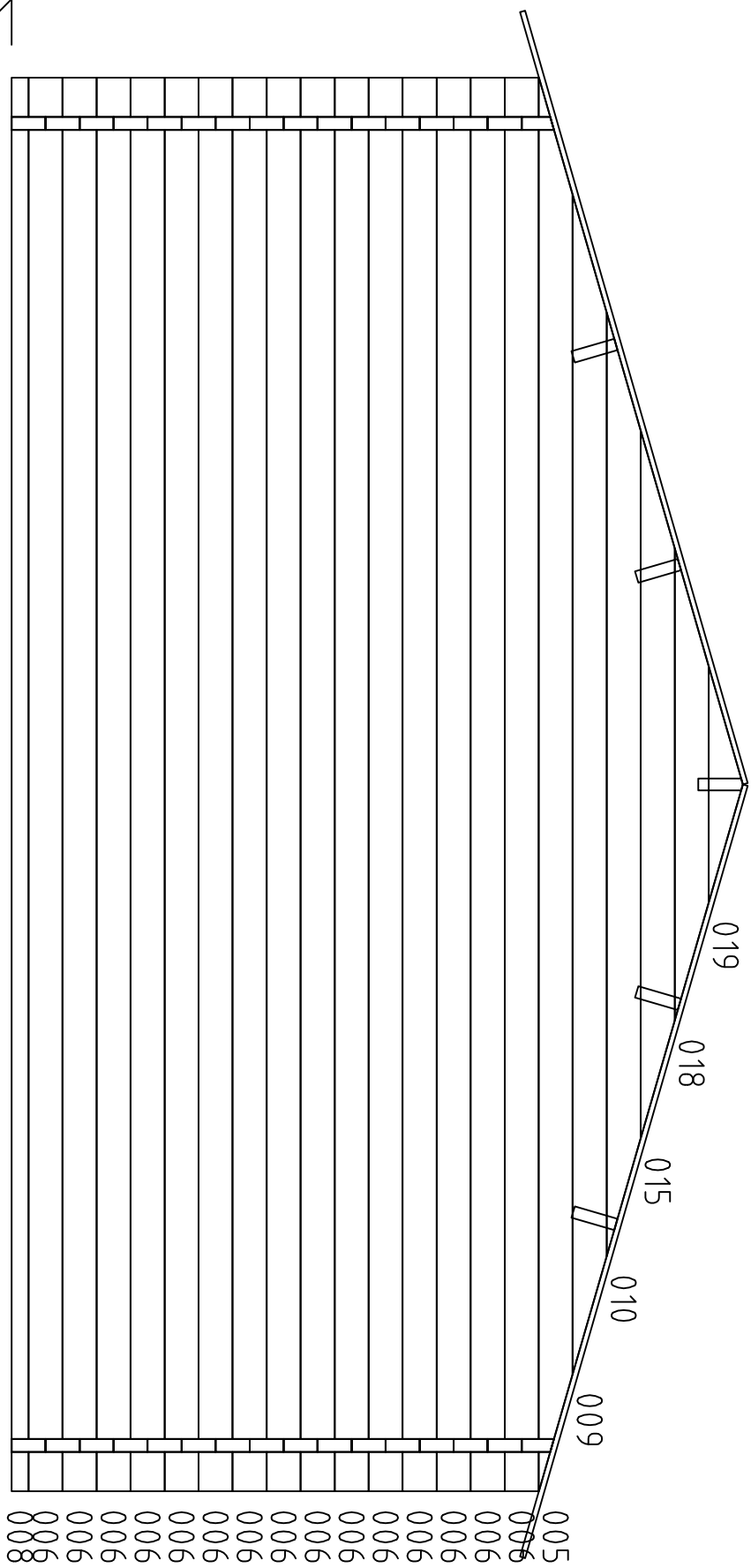

Wand A ↗

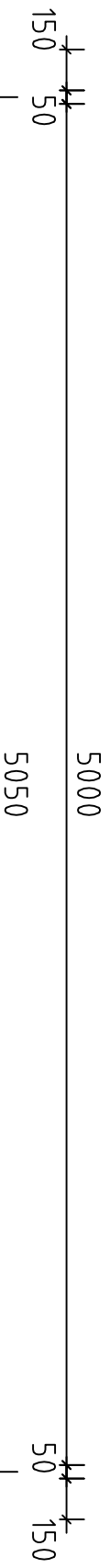

② 5X5 / 50 / 2013

①

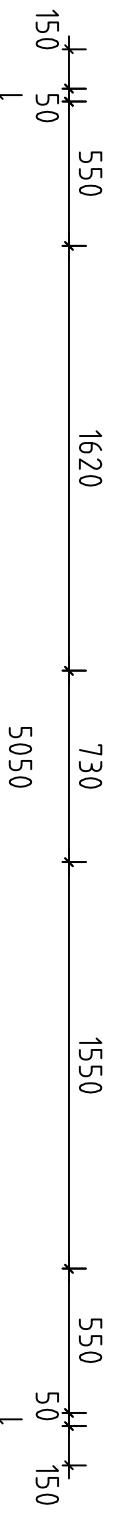
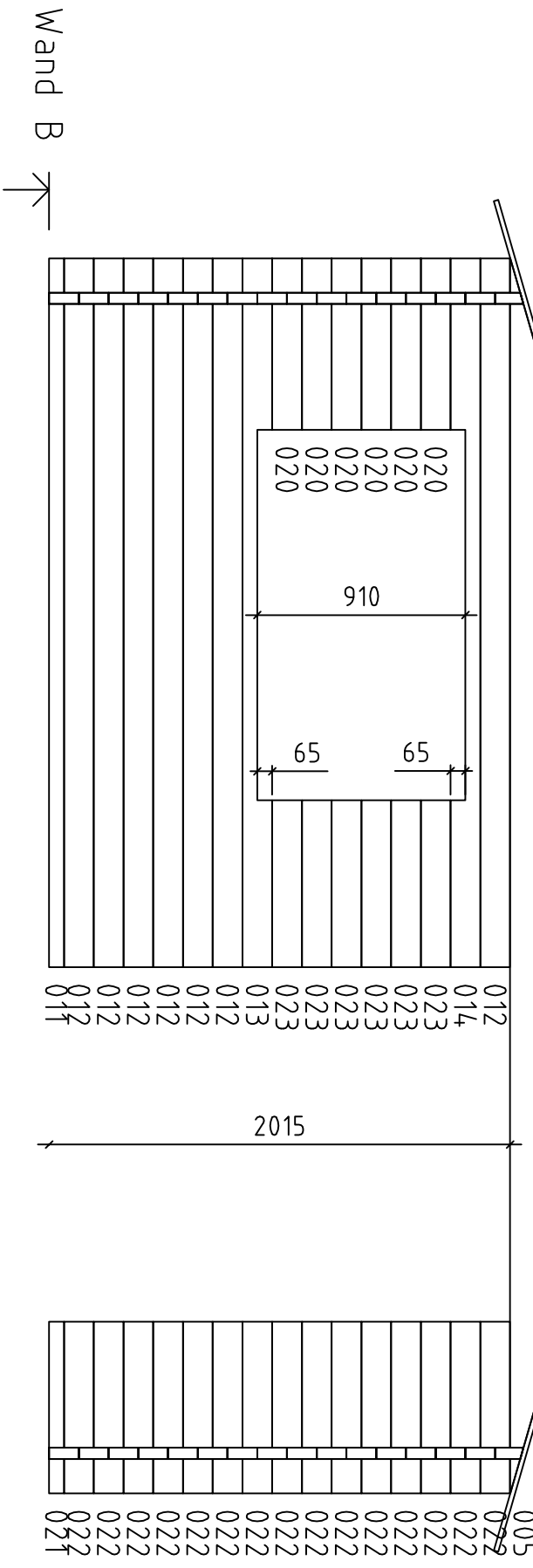
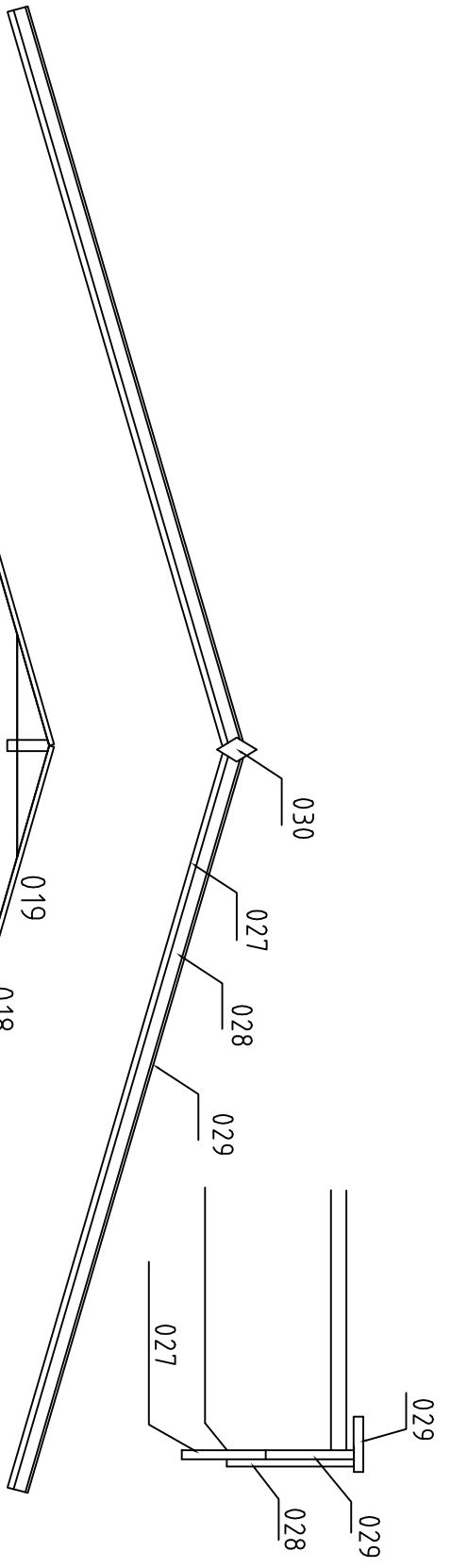

5X5 / 50 / 2013

2

1

Wand 1 ↗

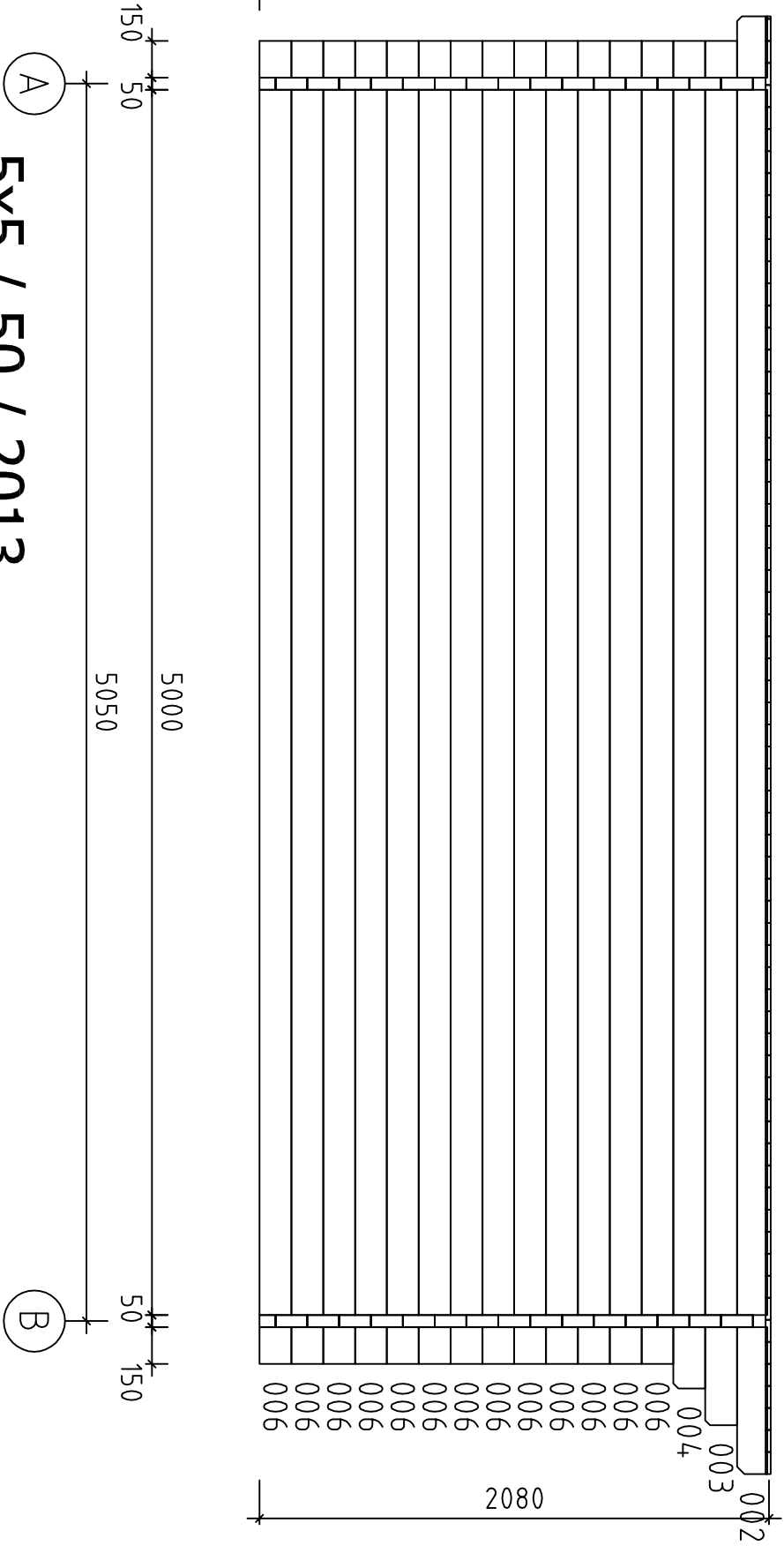



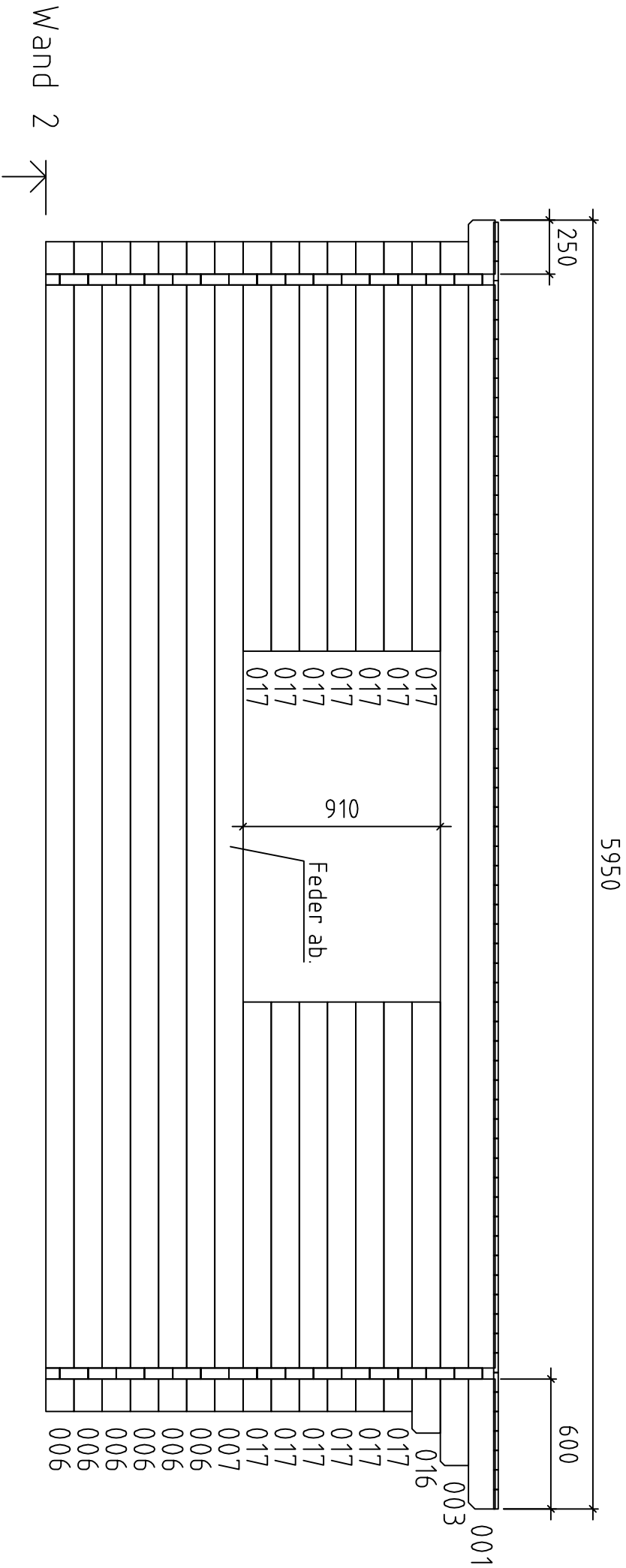



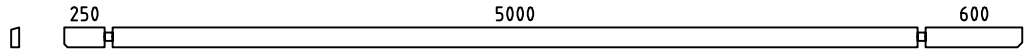
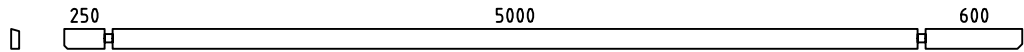
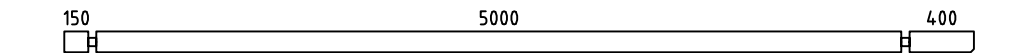
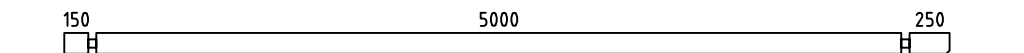
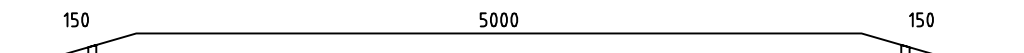
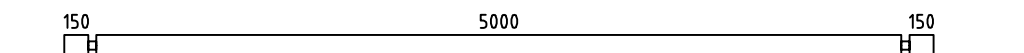
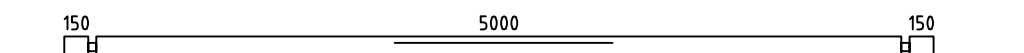
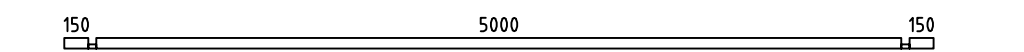
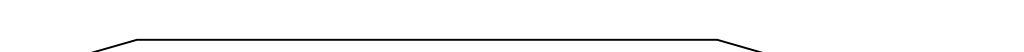

5X5 / 50 / 2013

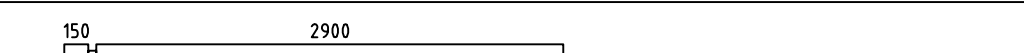
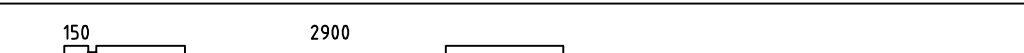
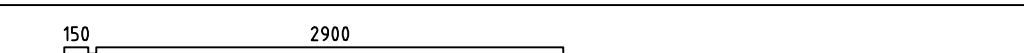

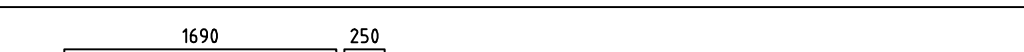
(A) **5X5 / 50 / 2013**

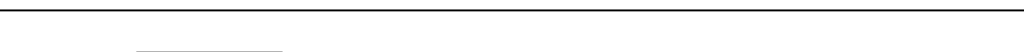
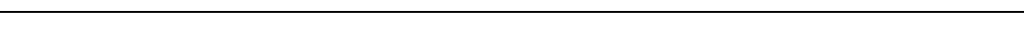
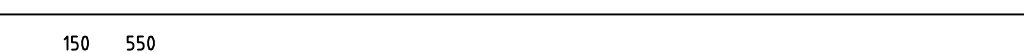
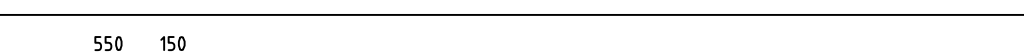
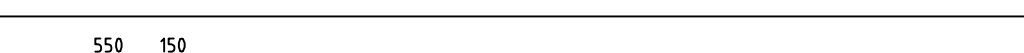
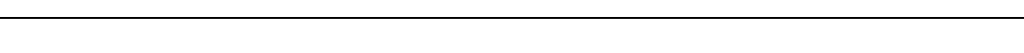
(B)

Pos	5x5 / 50 / 2013	ST	F (mm)	L (mm)
001		1	50x124	5950
002		1	50x124	5950
003		2	50x130	5650
004		1	50x130	5500
005		2	50x130	5400
006		34	50x130	5400
007		1	50x130	5400
008		1	50x65	5400
009		2	50x130	4506
010		2	50x130	3605
011		1	50x65	3100
012		7	50x130	3100
013		1	50x130	3100
014		1	50x130	3100
015		2	50x130	2703
016		1	50x130	1990
017		13	50x130	1890
018		2	50x130	1802
019		2	50x130	901
020		6	50x130	750
021		1	50x65	750
022		15	50x130	750
023		6	50x130	730
PR1		4	45x190	5950
PR2		1	45x190	5950

Doppeltür

Beschlag:

Türklinen mit der Lasche = 1 Kmp.

Schraube 5x80mm = 4 St.

Schnepper mit Schlüsseln = 1 Kmp.

Metallechen (zwei St.) Pos. 5,
befinden sich auf untere oder
obere Türflügelkante.

