

5x4 / 50 / 2013

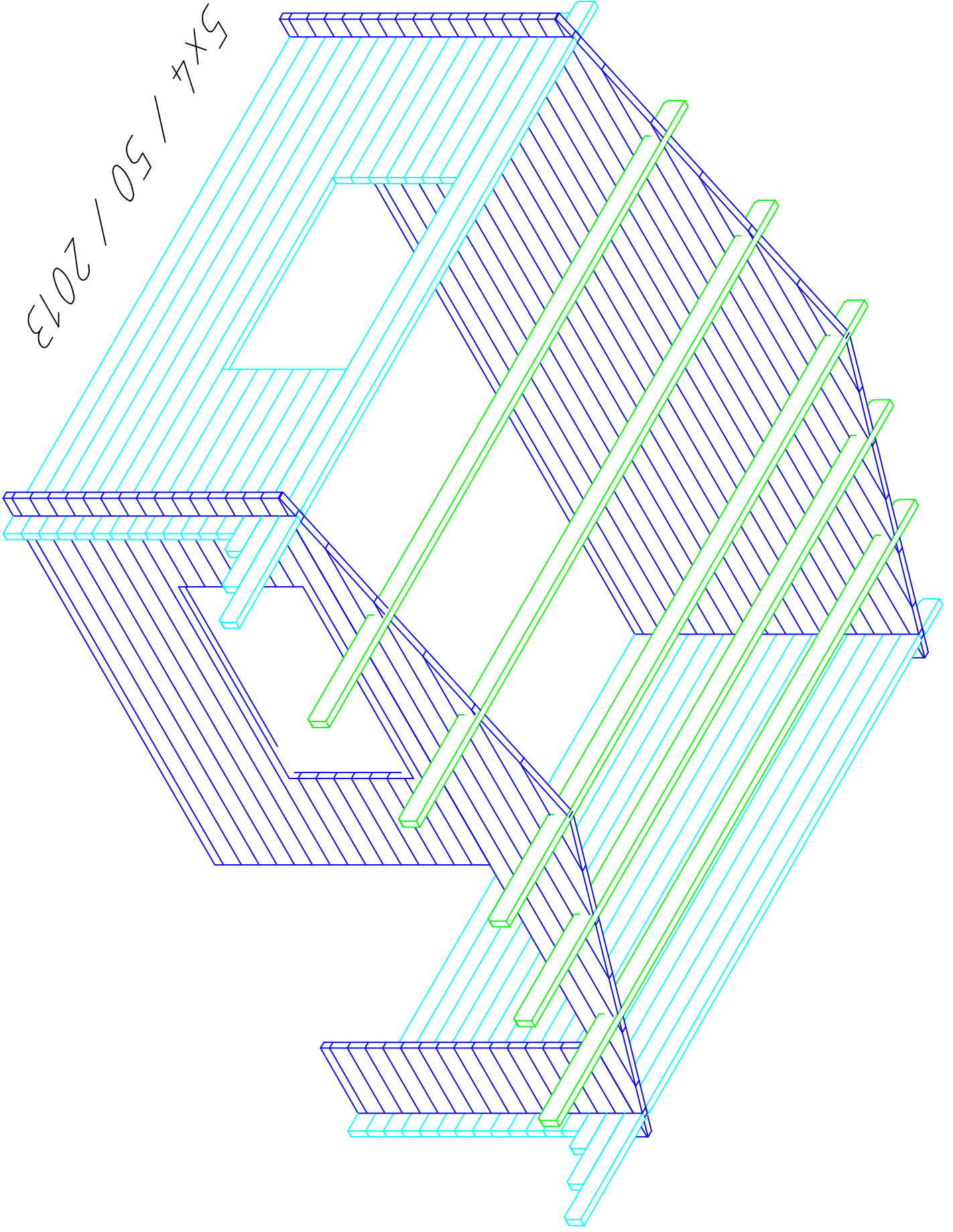

5x4 / 50 / 2013

4100

4000

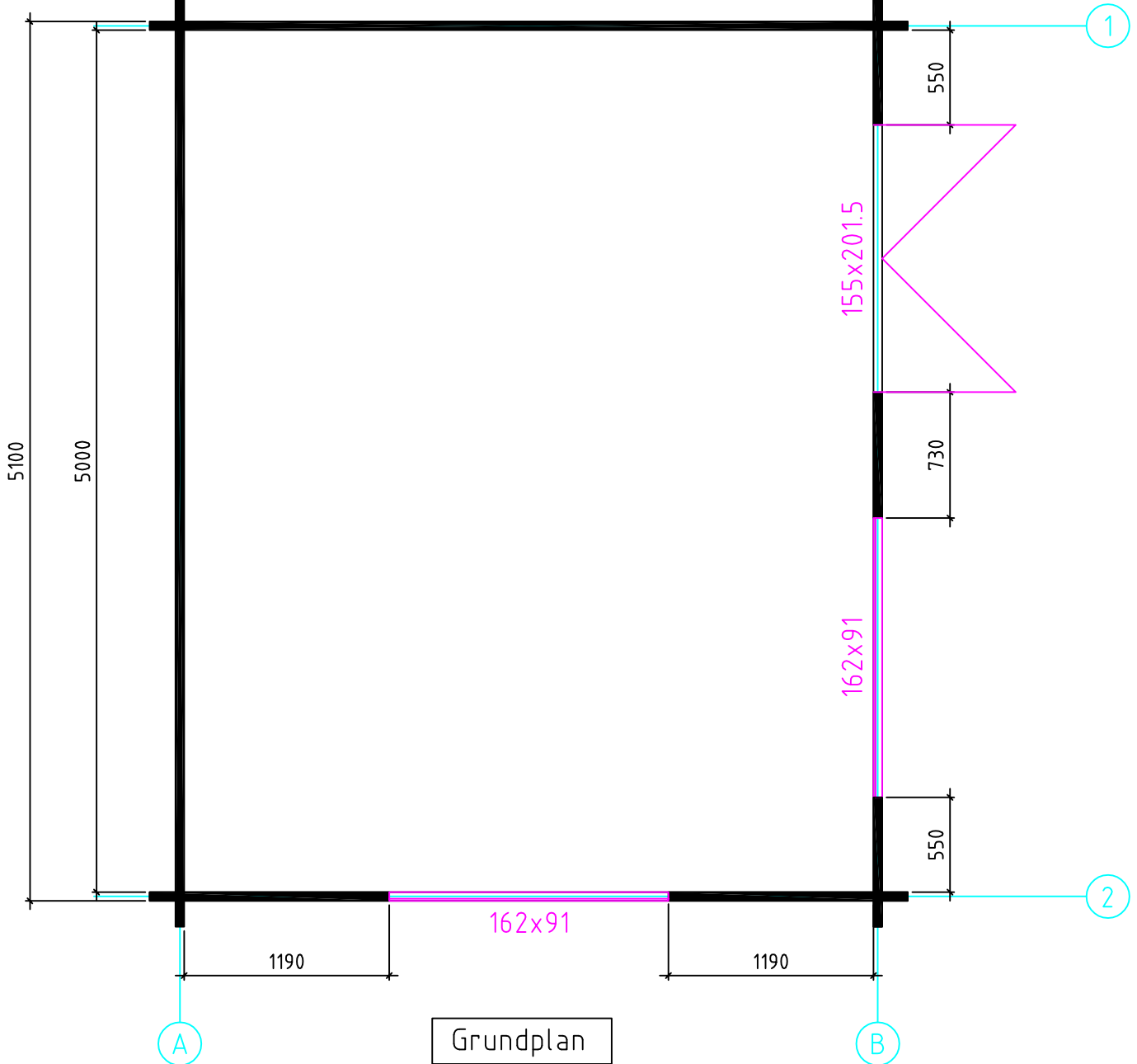

1

2

Grundplan

A

B

1190

1190

162x91

162x91

155x201.5

730

550

550

5100

5000

Wand 1 ↗

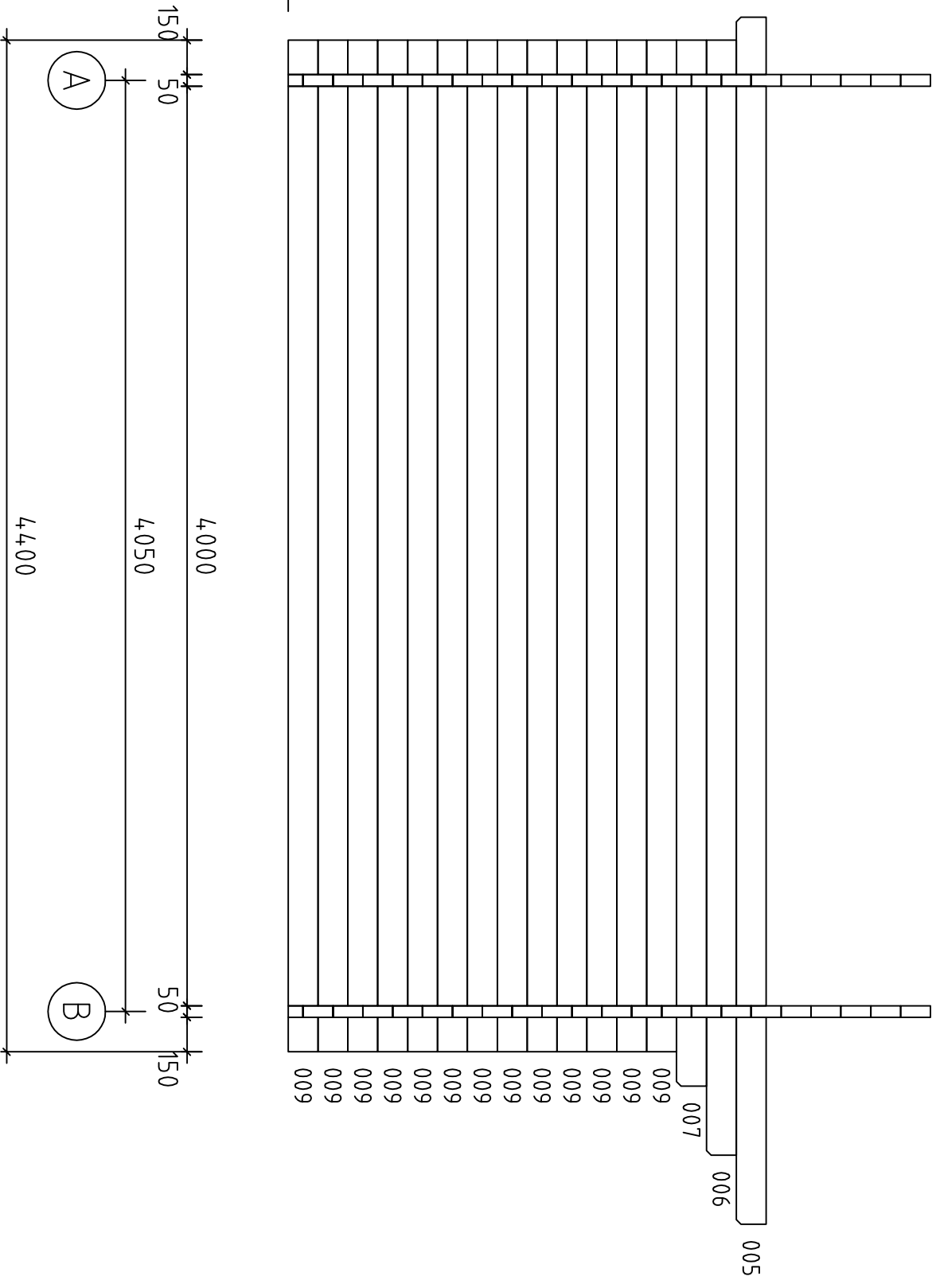



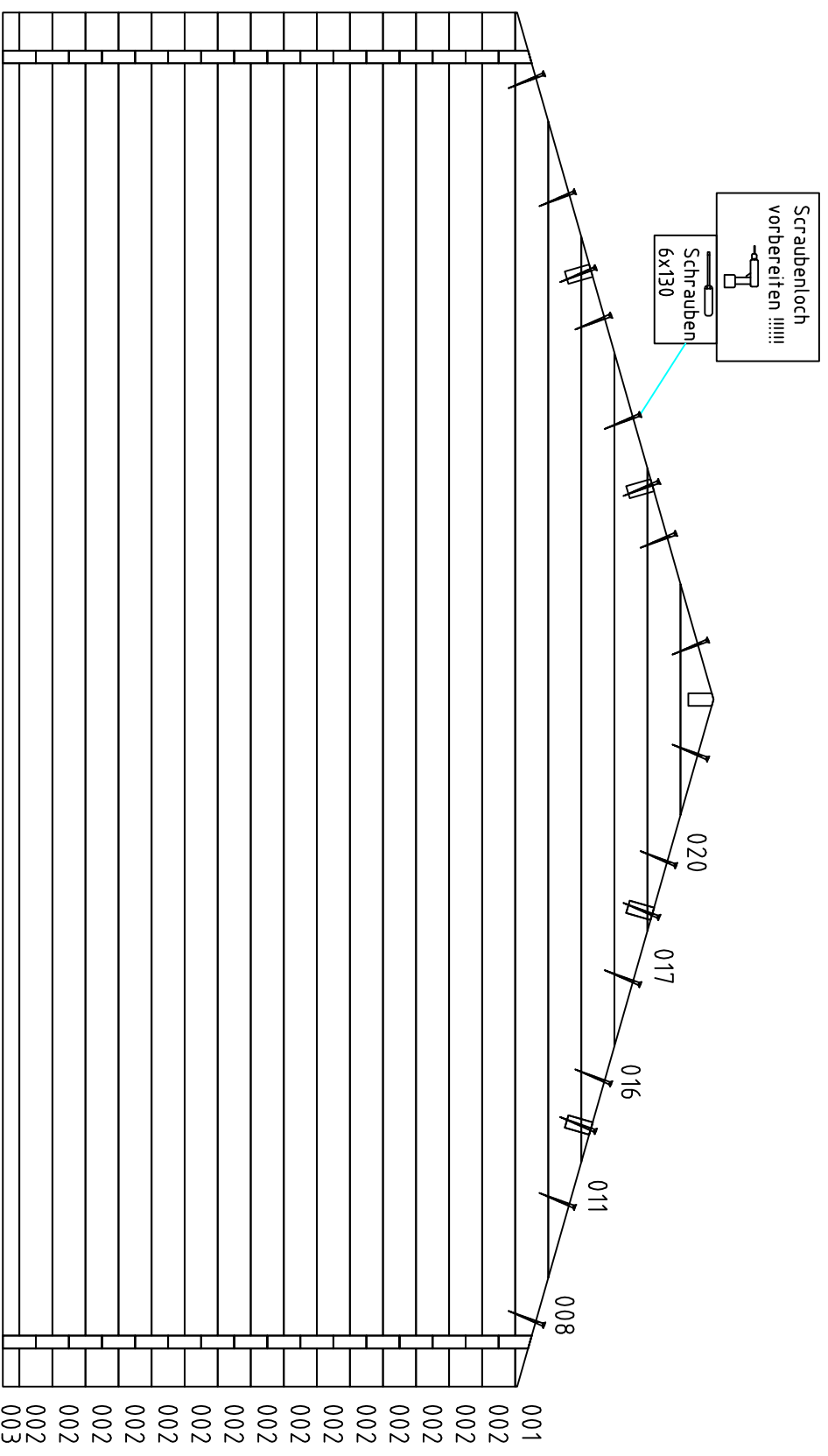

5x4 / 50 / 2013

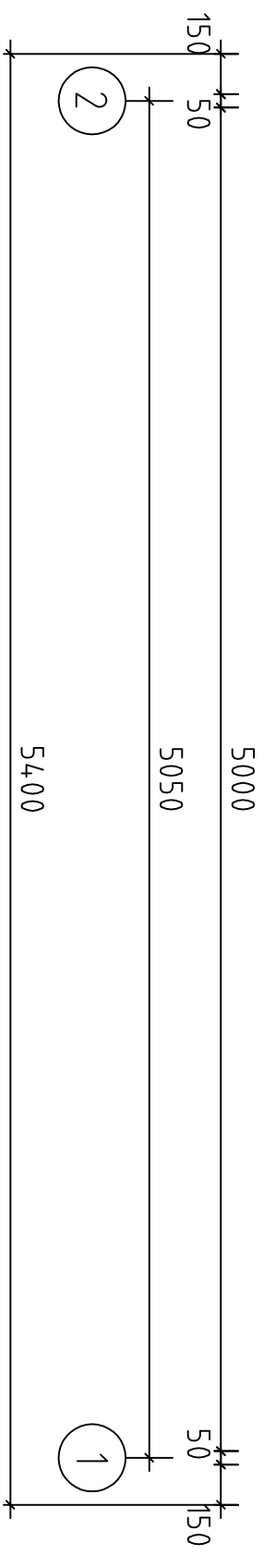

Wand A

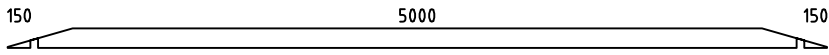
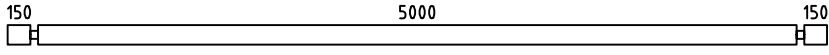
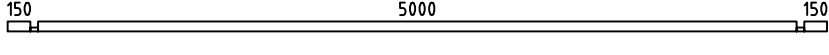
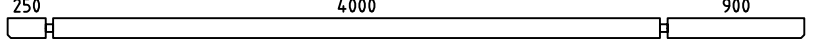
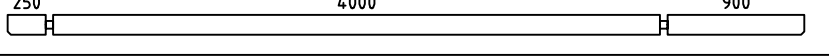
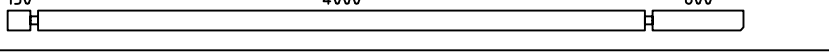
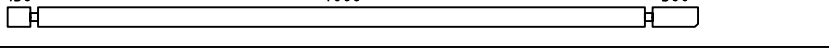
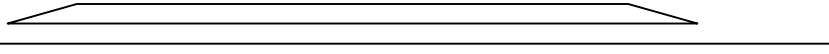
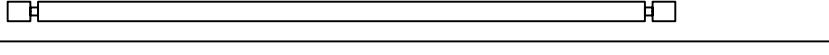
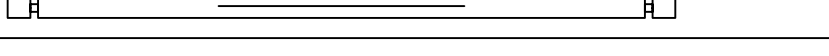
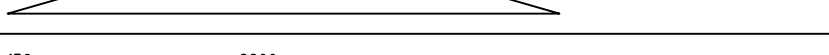
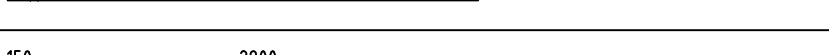
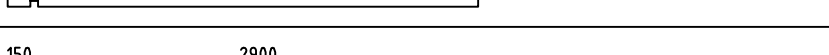
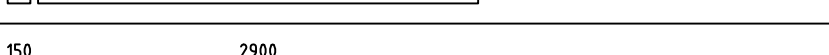
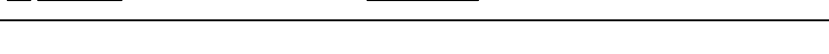
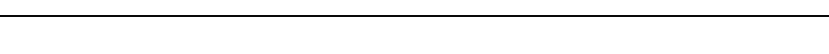
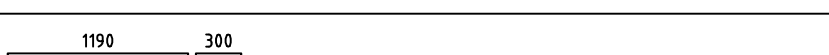
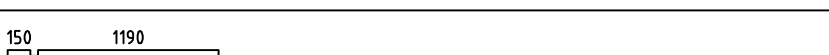
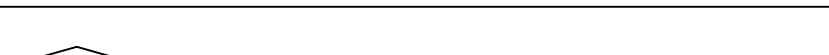
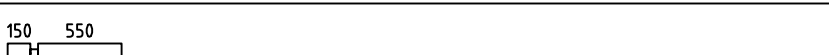

5x4 / 50 / 2013

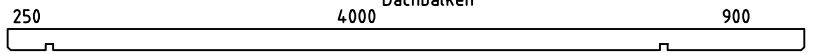
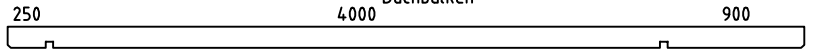
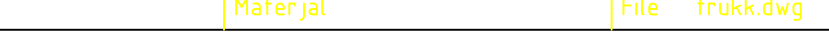
Pos	5x4 / 50 / 2013	ST	F (mm)	L (mm)
001		2	50x130	5400
002		15	50x130	5400
003		1	50x65	5400
004		1	50x130	5250
005		1	50x130	5250
006		2	50x130	4850
007		1	50x130	4550
008		2	50x130	4545
009		19	50x130	4400
010		1	50x130	4400
011		2	50x130	3636
012		1	50x65	3100
013		7	50x130	3100
014		1	50x130	3100
015		1	50x130	3100
016		2	50x130	2727
017		2	50x130	1818
018		1	50x130	1540
019		13	50x130	1390
020		2	50x130	909
021		6	50x130	750
022		1	50x65	750
023		15	50x130	750
024		6	50x130	730
PR1		4	50x140	5250
PR2		1	50x140	5250

Doppeltür

Beschlag:

Türklinken mit der Lasche = 1 Kmp.

Schraubeh 5x80mm = 4 St.

Schnepper mit Schlüsseln = 1 Kmp.

Metalblechen (zwei St.) Pos. 5,
befinden sich auf untere oder
obene Türflügelkante.

Schrauben 5x80

Schrauben 5x80

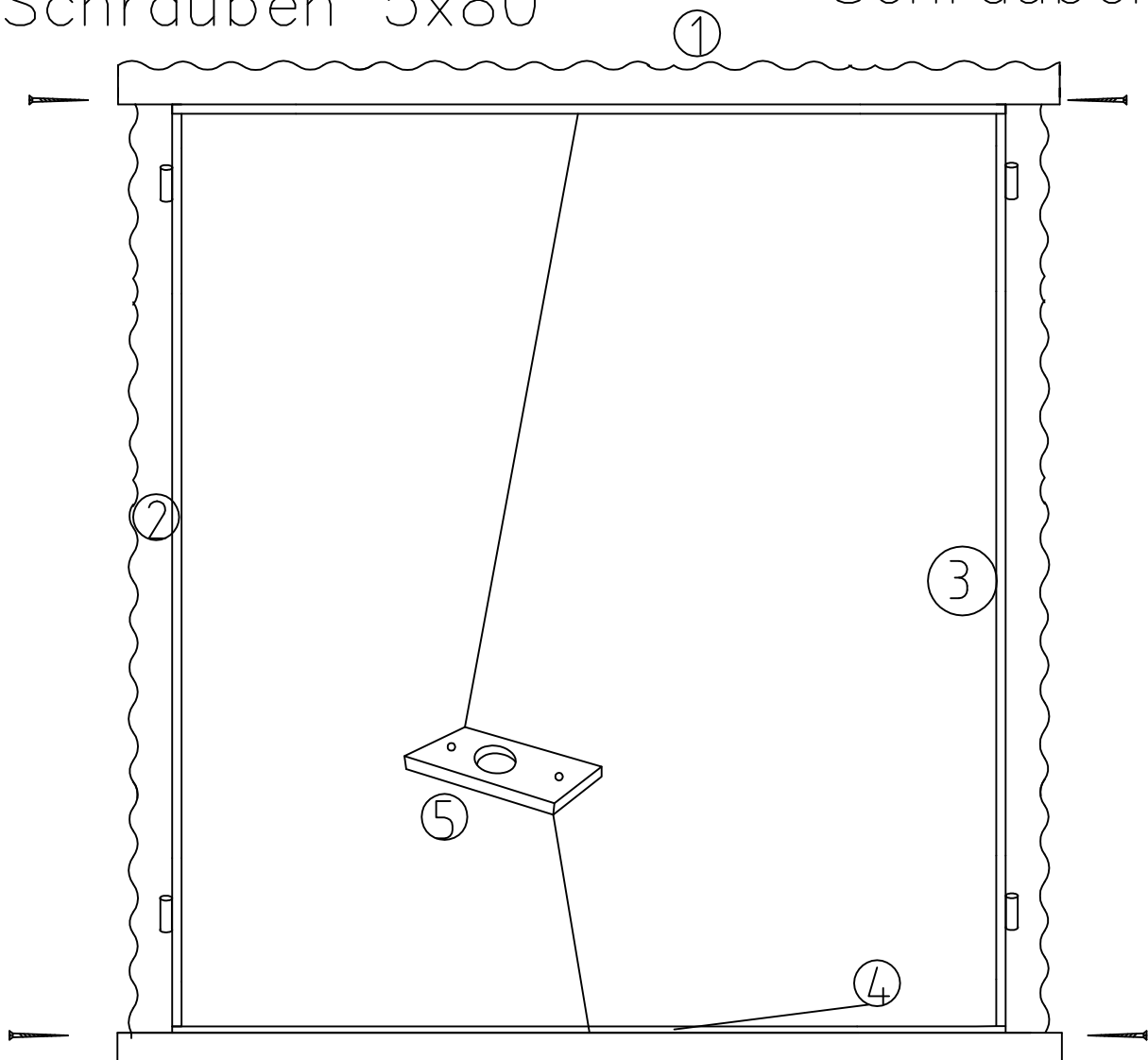

Schrauben 5x80

Schrauben 5x80