

4x4+2+Z AU / 50 / 08

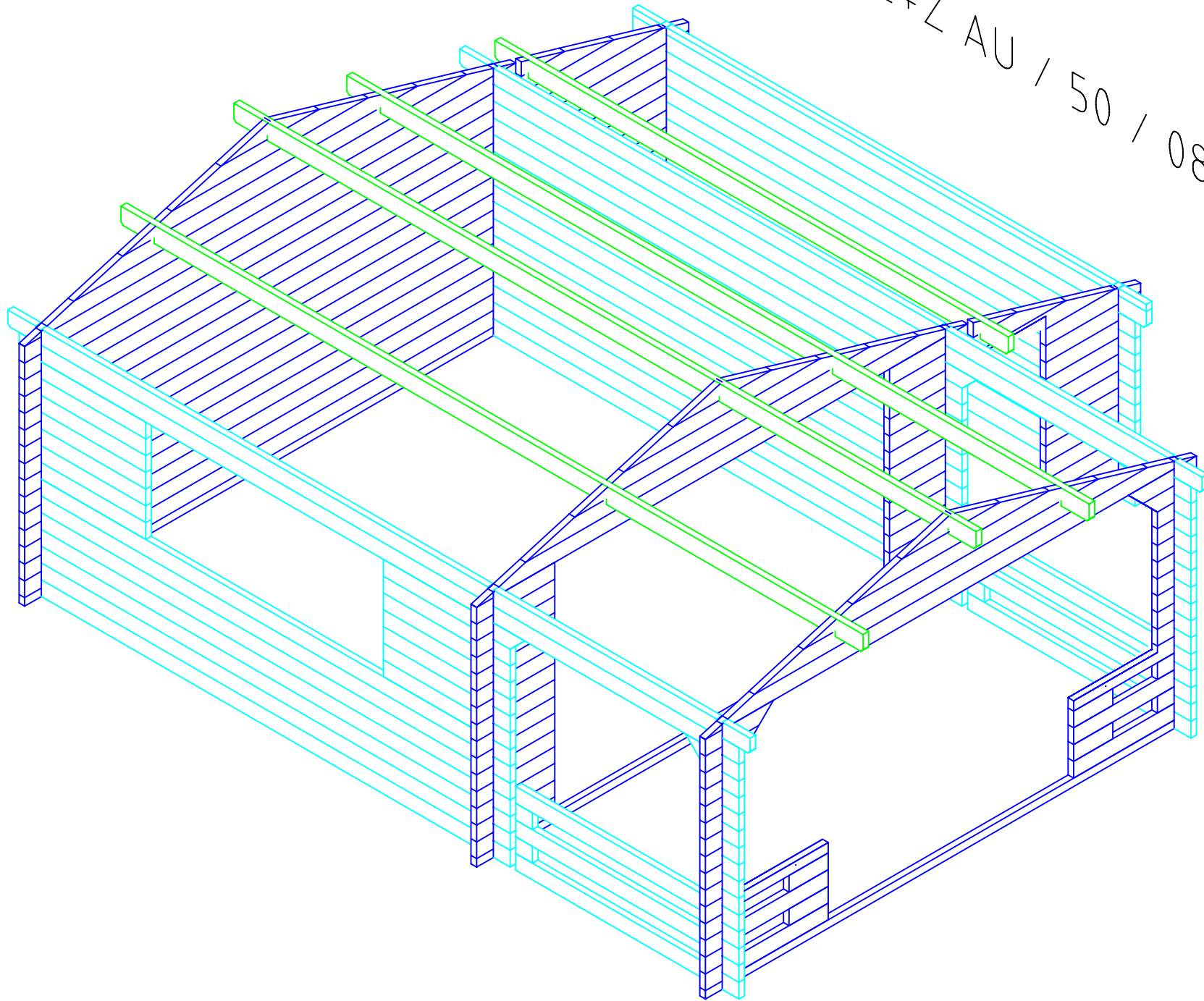

4x4+2+Z AU / 50 / 08

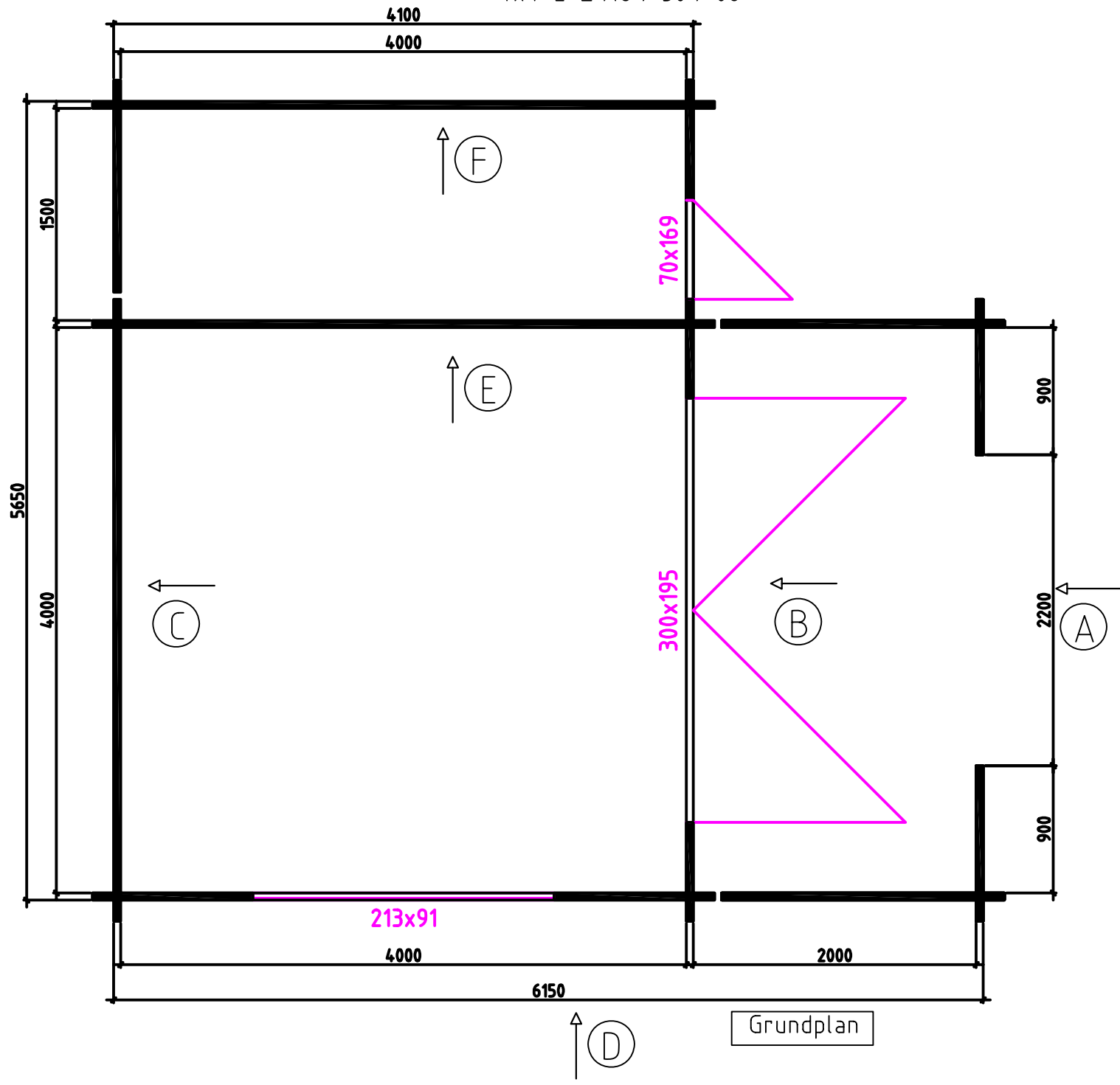

Grundplan

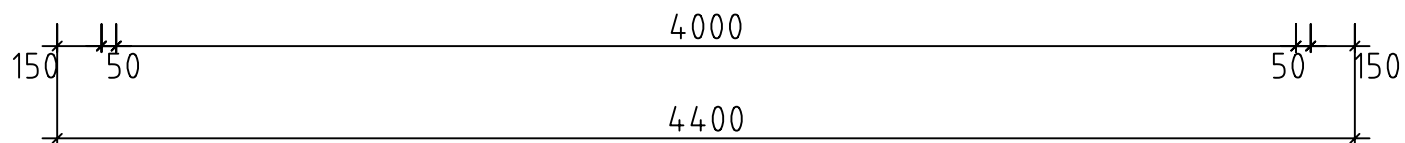
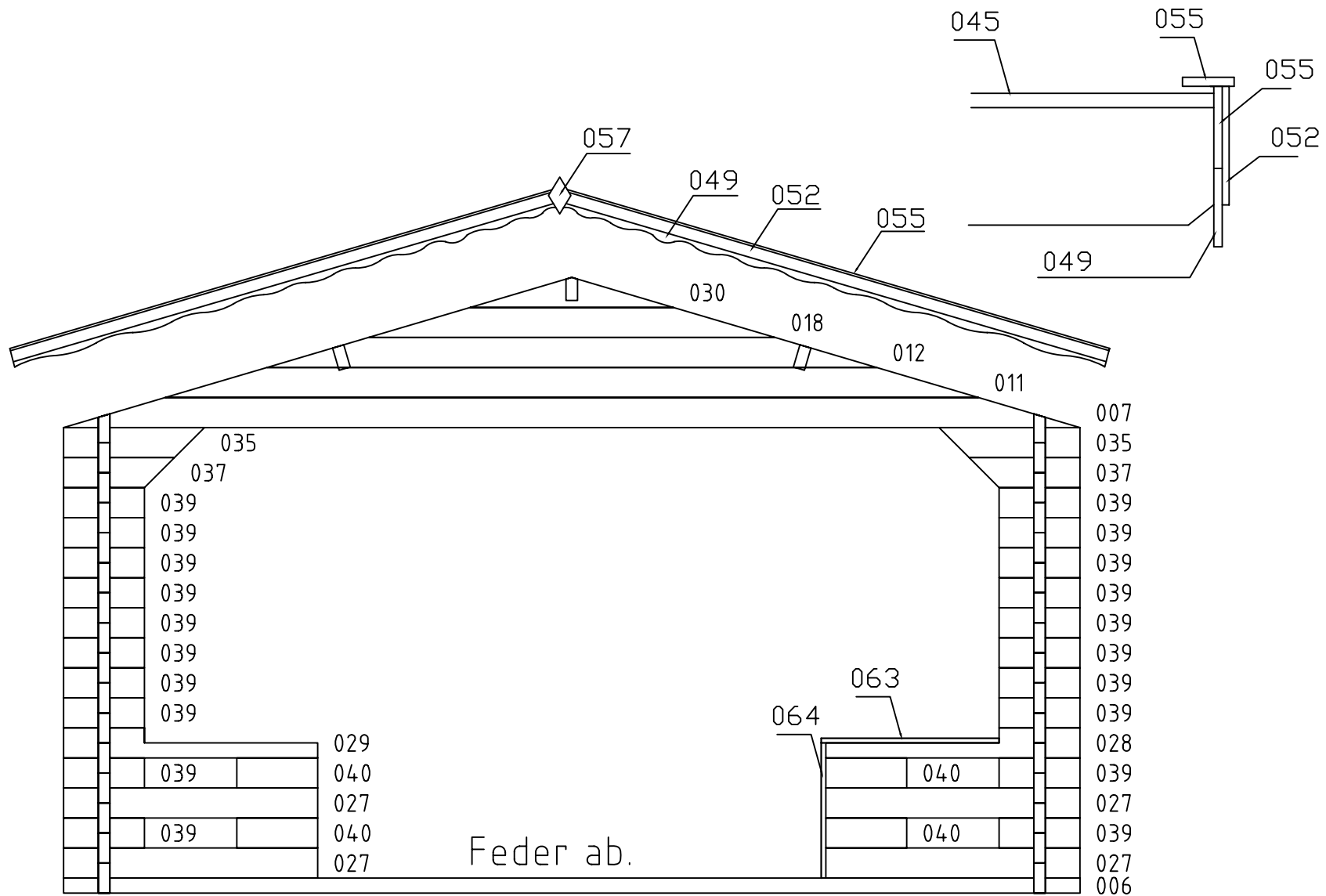

4x4+2+Z / 50 / 08 AU

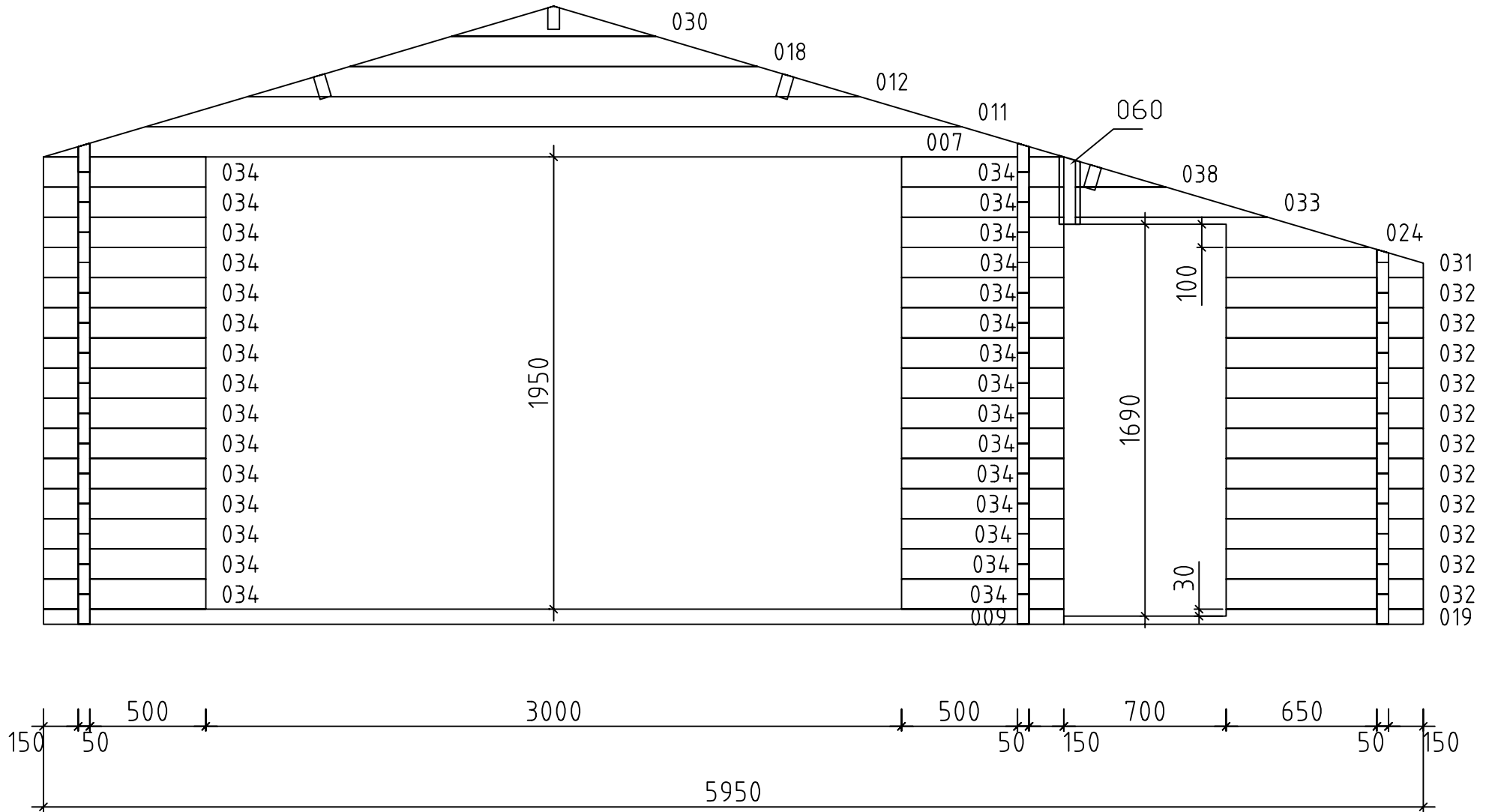

4x4+2+Z / 50 / 08 AU

B

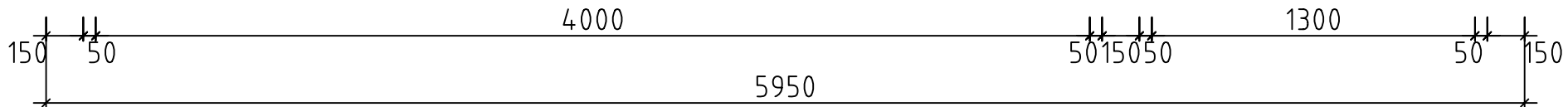
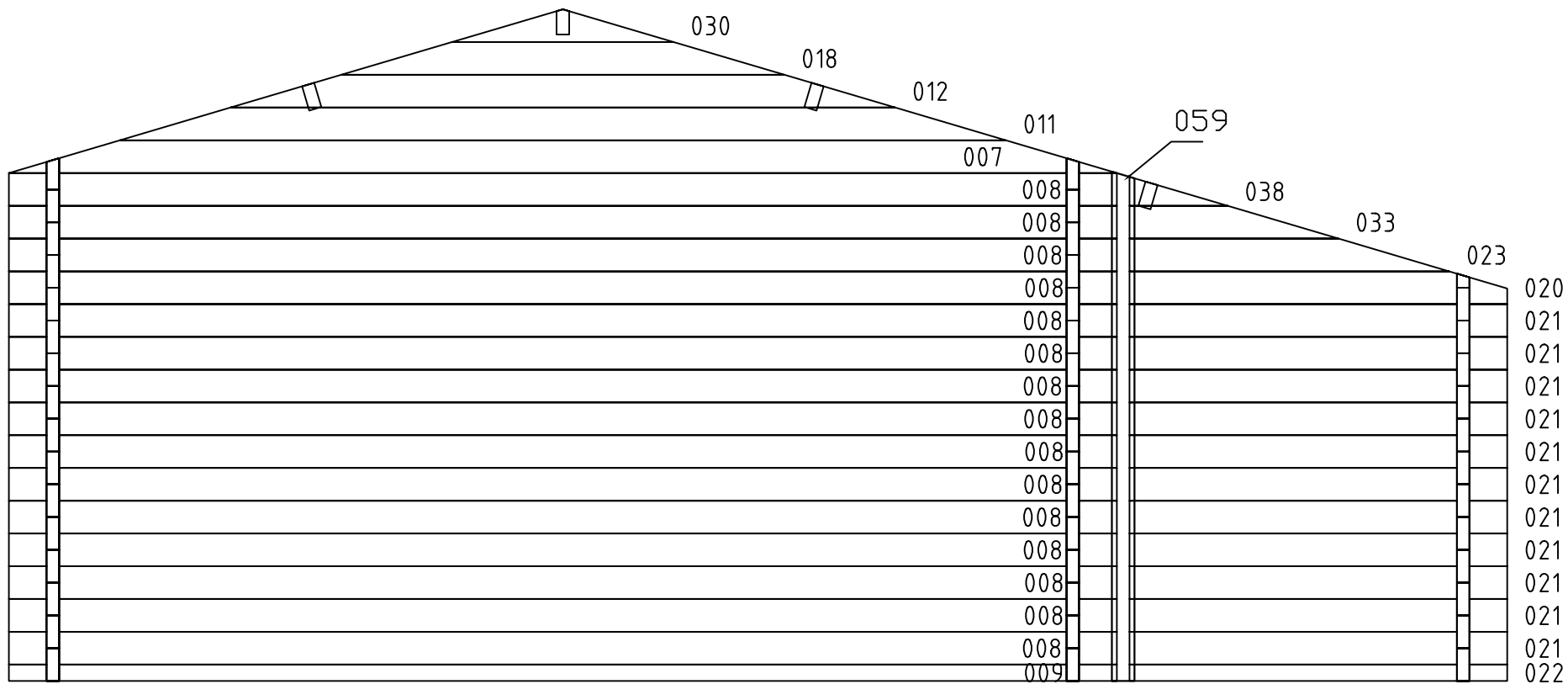

4x4+2+Z / 50 / 08 AU

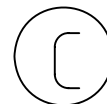

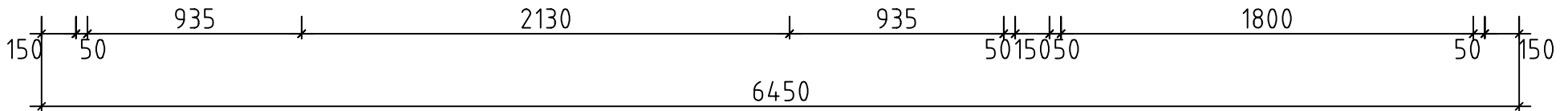
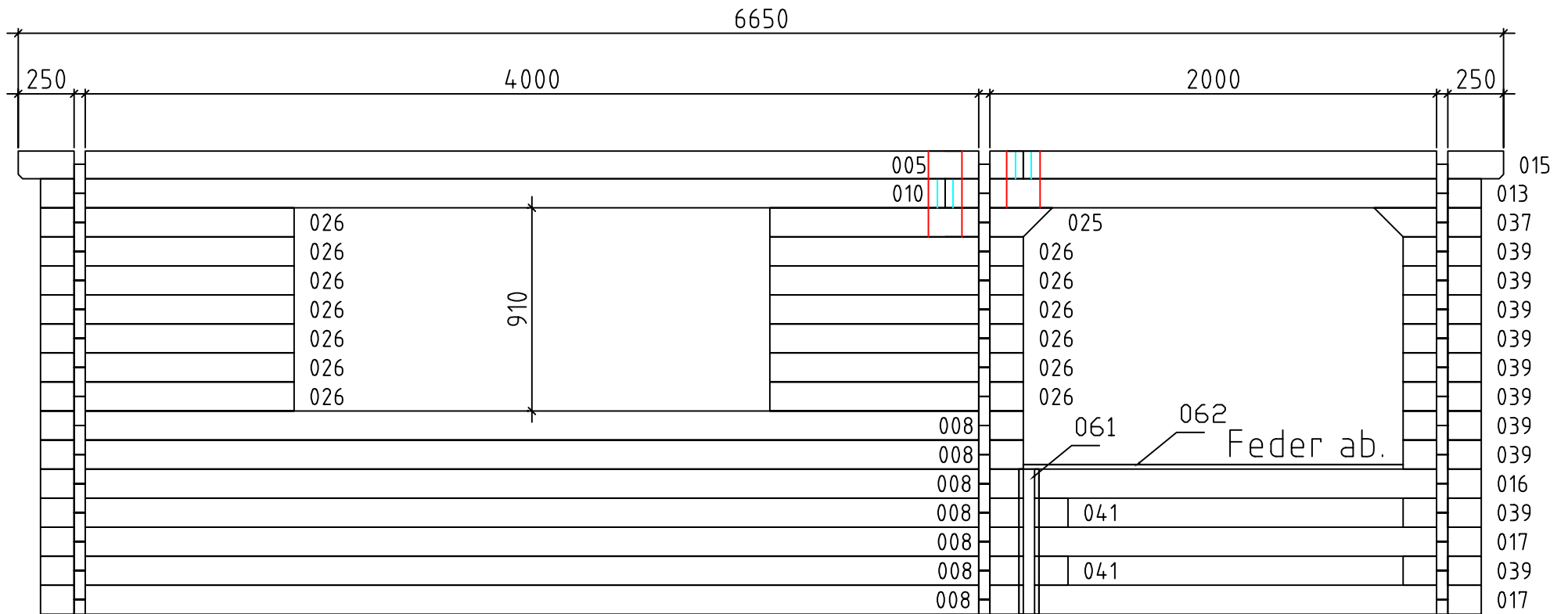

4x4+2+Z / 50 / 08 AU



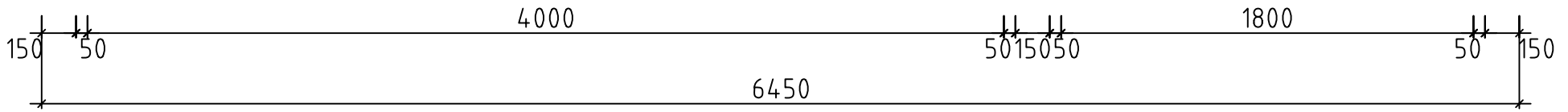
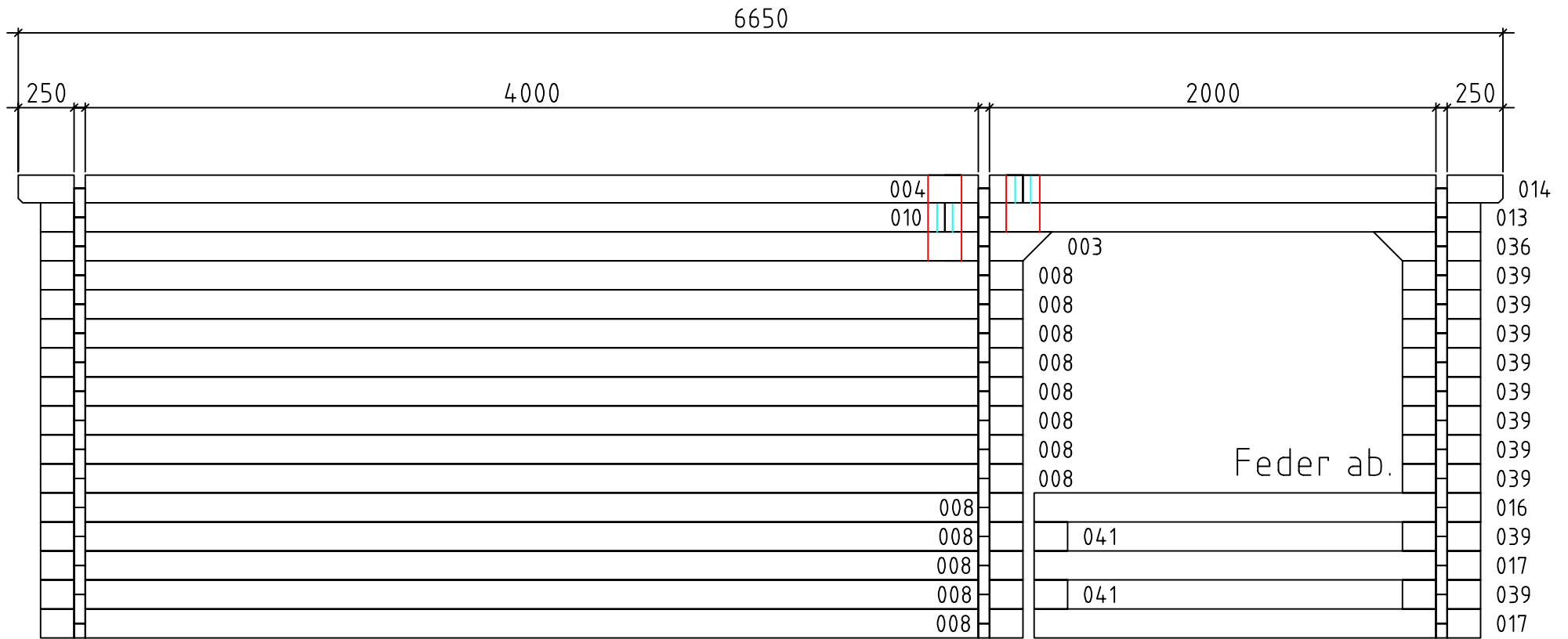

4x4+2+Z / 50 / 08 AU



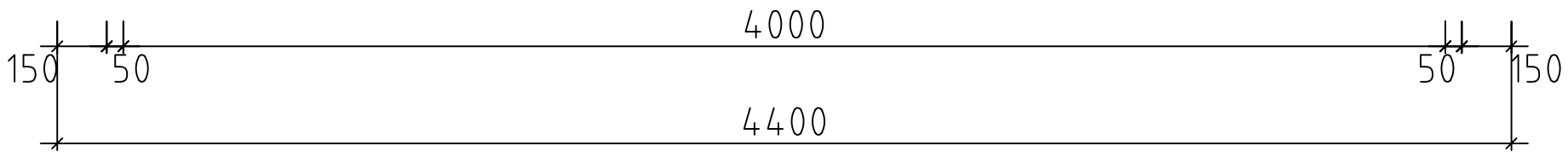
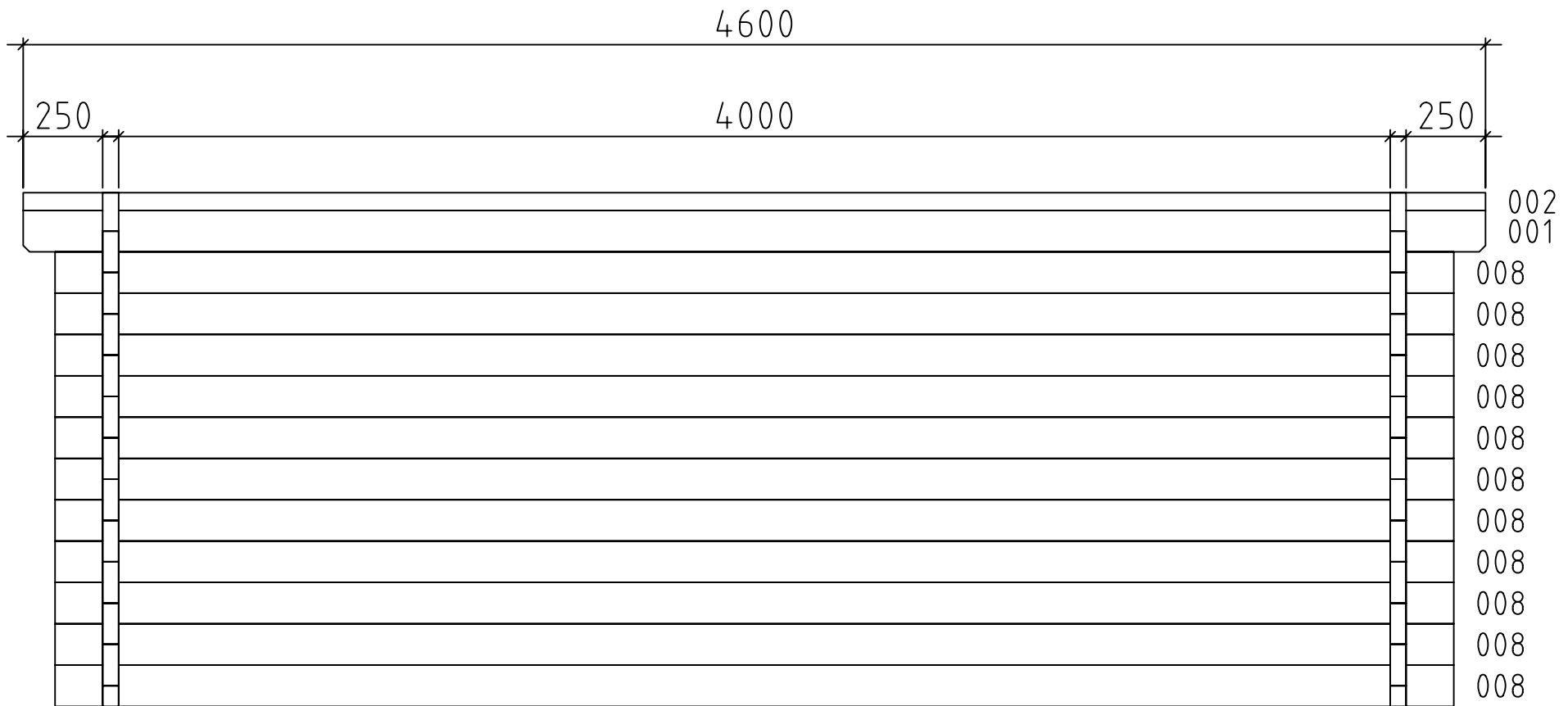







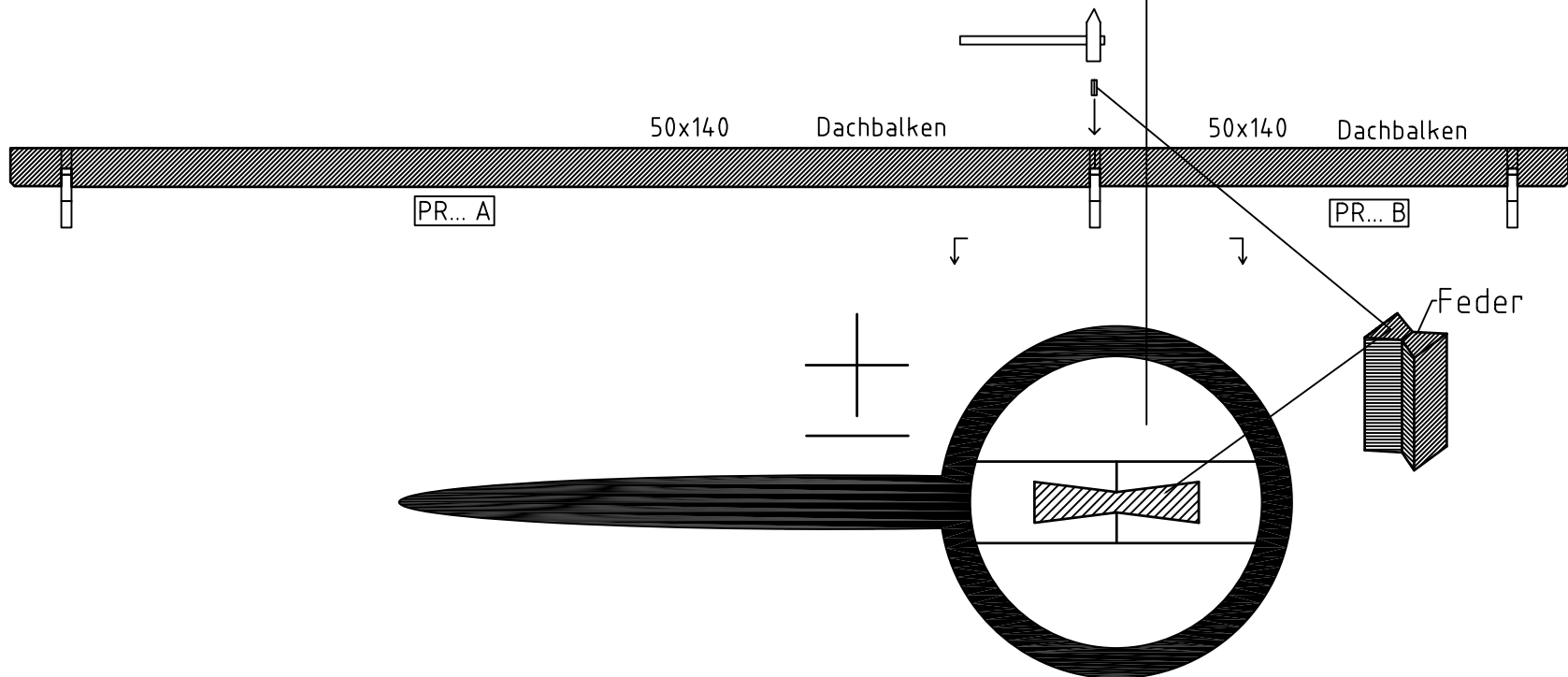
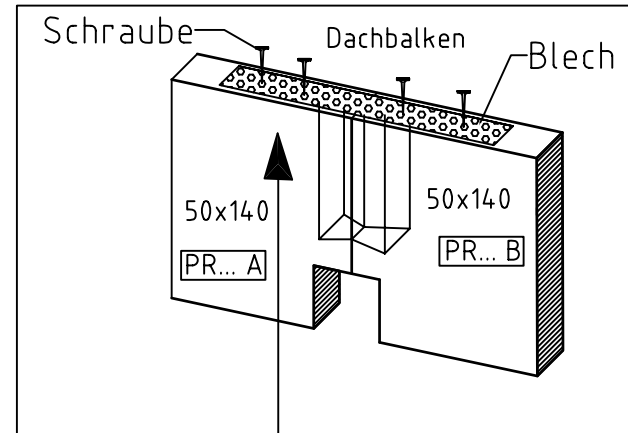

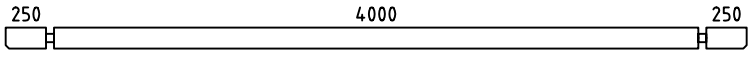
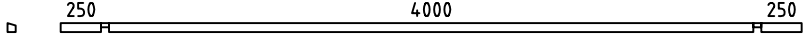
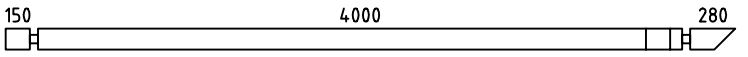
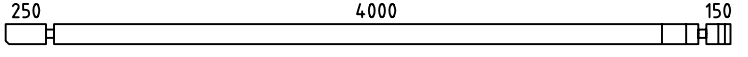
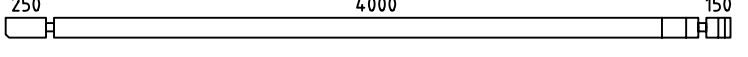
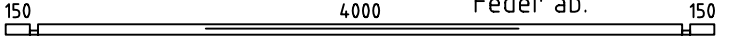
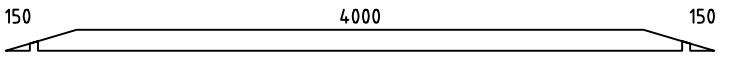
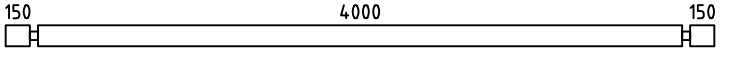
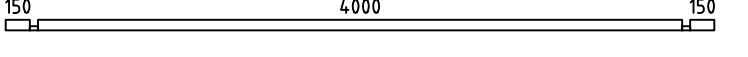
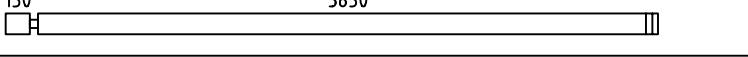
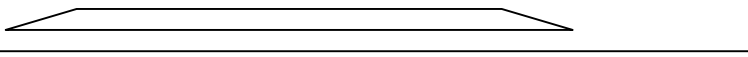
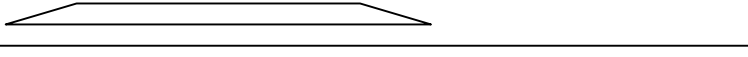

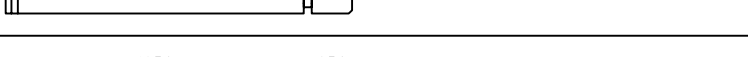
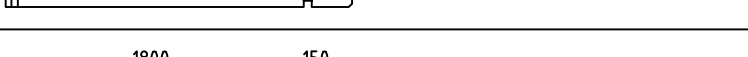
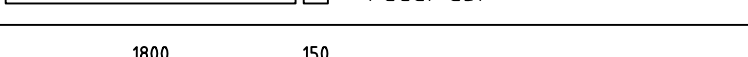
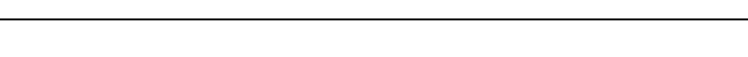
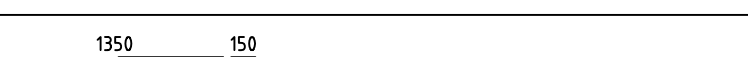

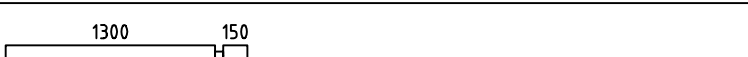
$4 \times 4 + 2 + Z / 50 / 08 \text{ AU}$



4x4+2+Z AU / 50 / 08

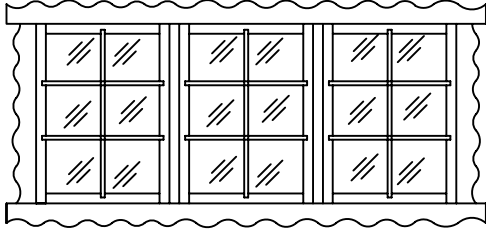
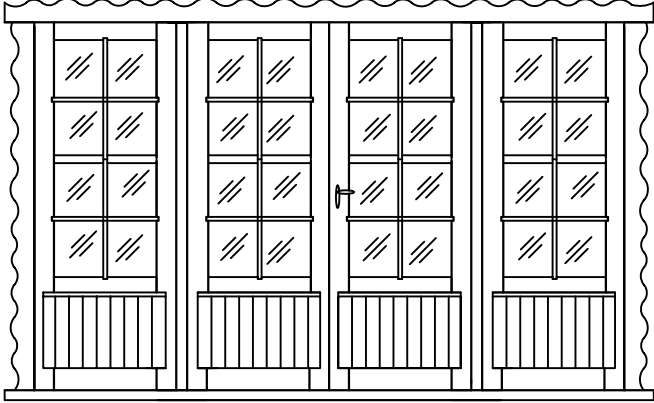
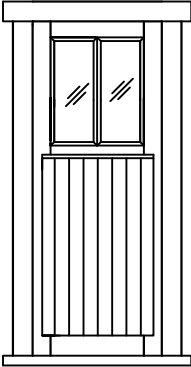
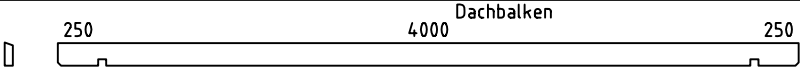
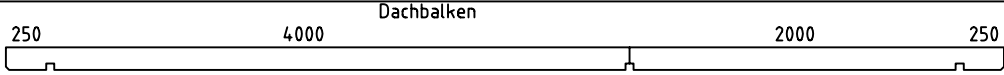
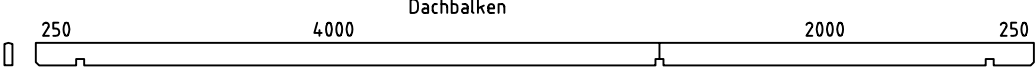
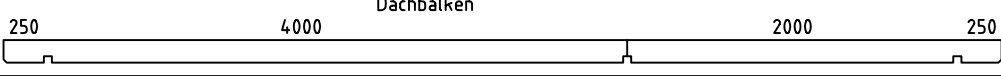

Pos	4x4+2+Z / 50 / 08 AU	ST	F (mm)	L (mm)
001		1	50x130	4600
002		1	50x56	4600
003		1	50x130	4530
004		1	50x124	4500
005		1	50x124	4500
006		1	50x65	4400
007		3	50x130	4400
008		46	50x130	4400
009		2	50x65	4400
010		2	50x130	4050
011		3	50x130	3520
012		3	50x130	2640
013		2	50x130	2400
014		1	50x124	2150
015		1	50x124	2150
016		2	50x130	2000
017		4	50x130	2000
018		3	50x130	1760
019		1	50x65	1550
020		1	50x130	1500
021		11	50x130	1500
022		1	50x65	1500
023		1	50x130	1270
024		1	50x130	1270
025		1	50x130	1265

Pos	4x4+2+Z / 50 / 08 AU	ST	F (mm)	L (mm)
A3L	Fenster 2130x910 	1		
UGT	Tür 3000x1950 	1		
UKHL	Tür 700x1680 	1		
PR4	 Dachbalken	1	50x140	4600
PR3	 Dachbalken	1	50x140	6650
PR2	 Dachbalken	1	50x140	6650
PR1	 Dachbalken	1	50x140	6650
045	Dachbretter 	134	100x20	2490
046		46	100x20	1610
047	Abdeckleiste 		20x40	8m

