

4x3x3 / 50 / 2013

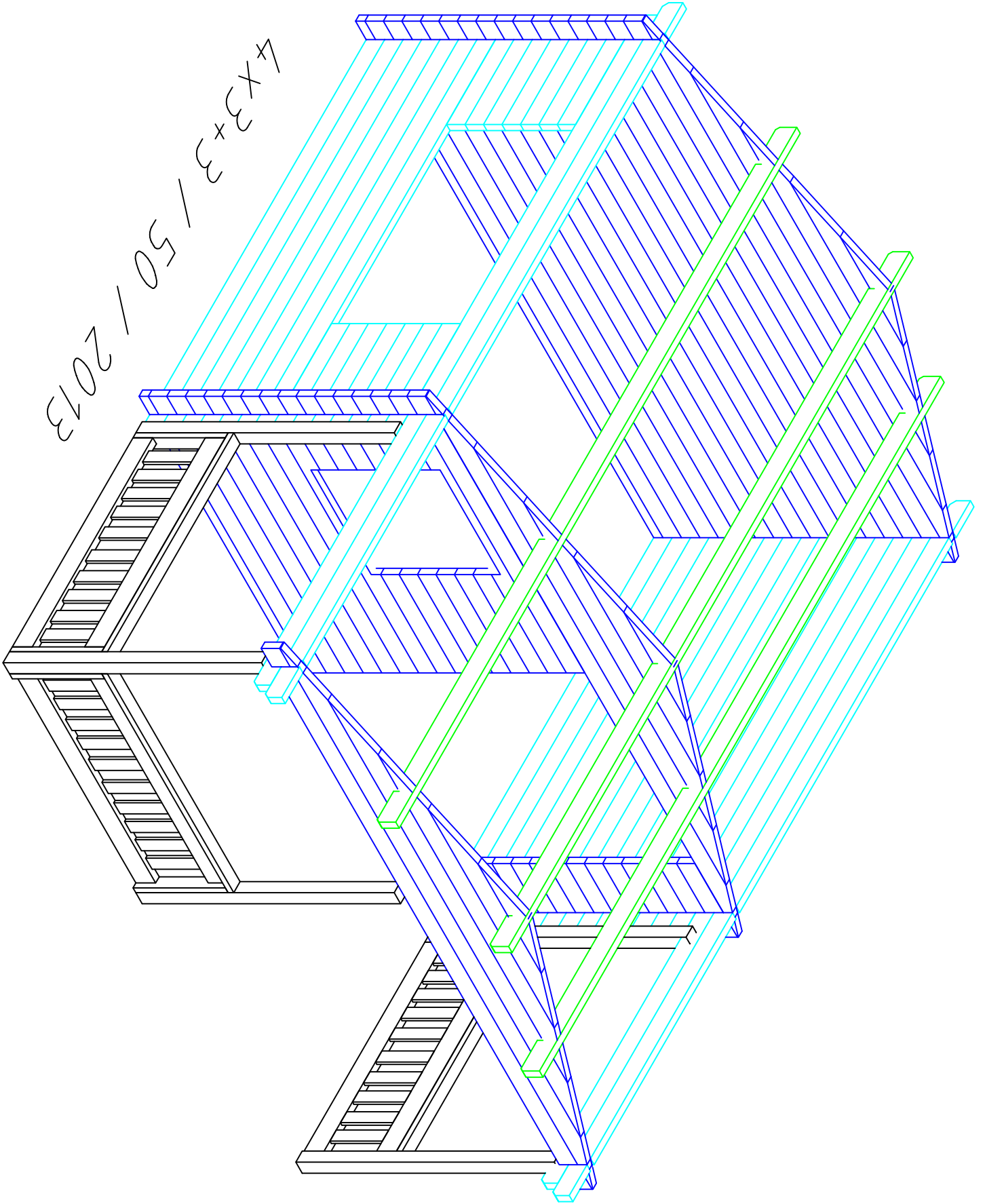

4x3+3 / 50 / 2013

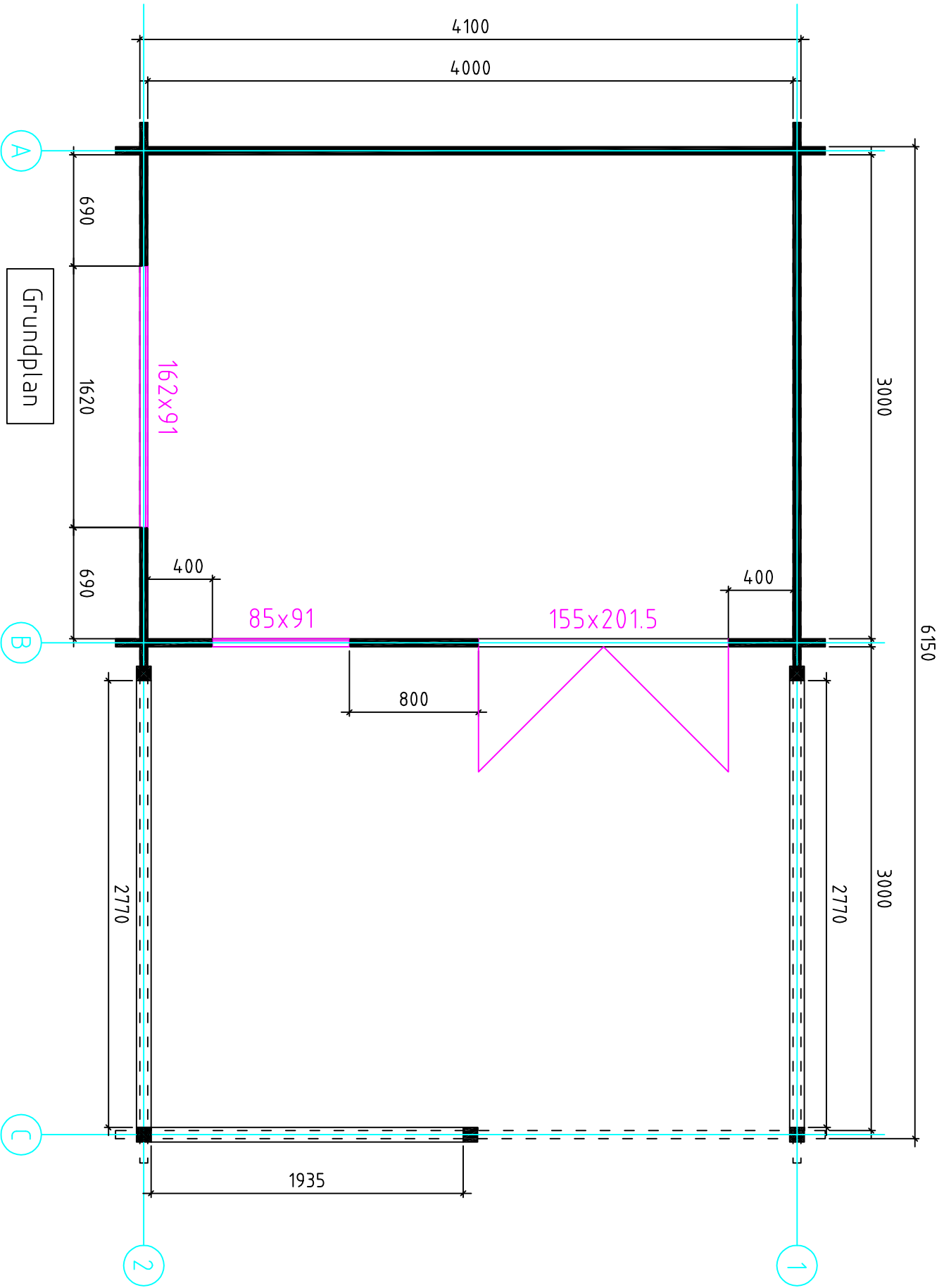

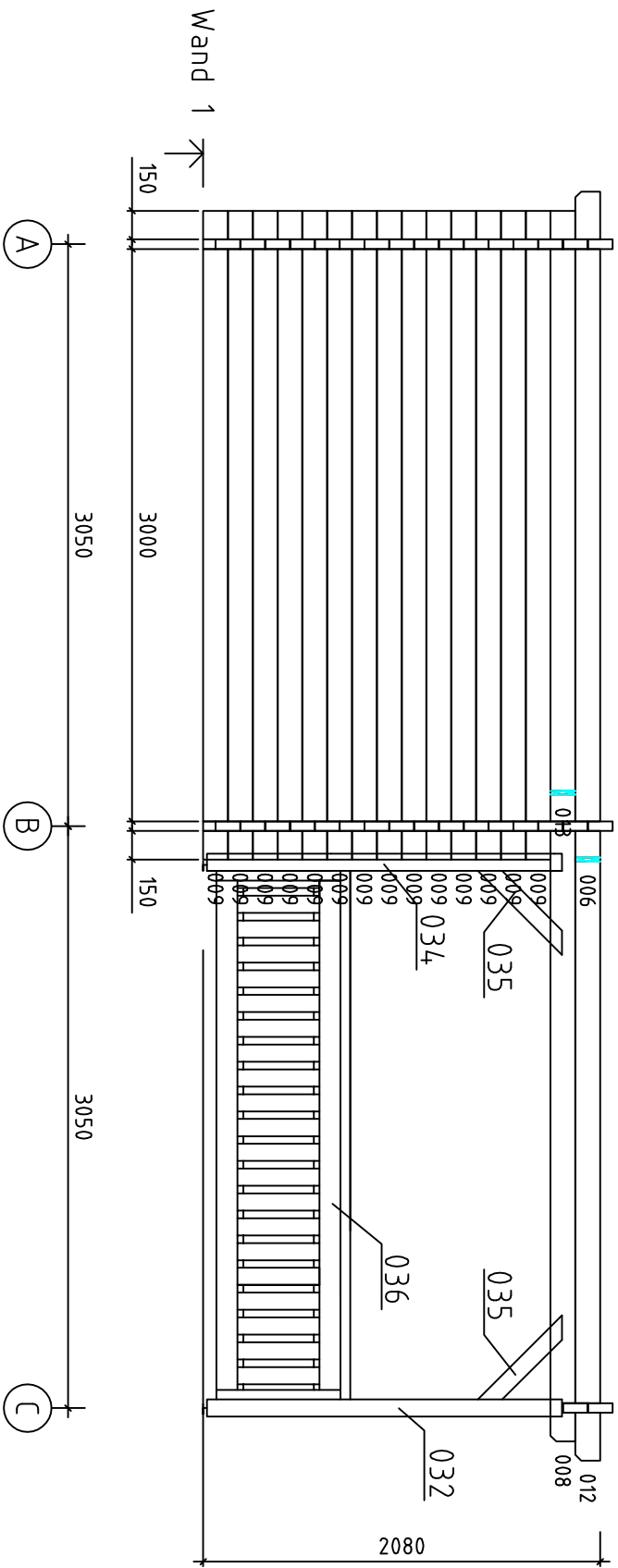

4x3+3 / 50 / 2013

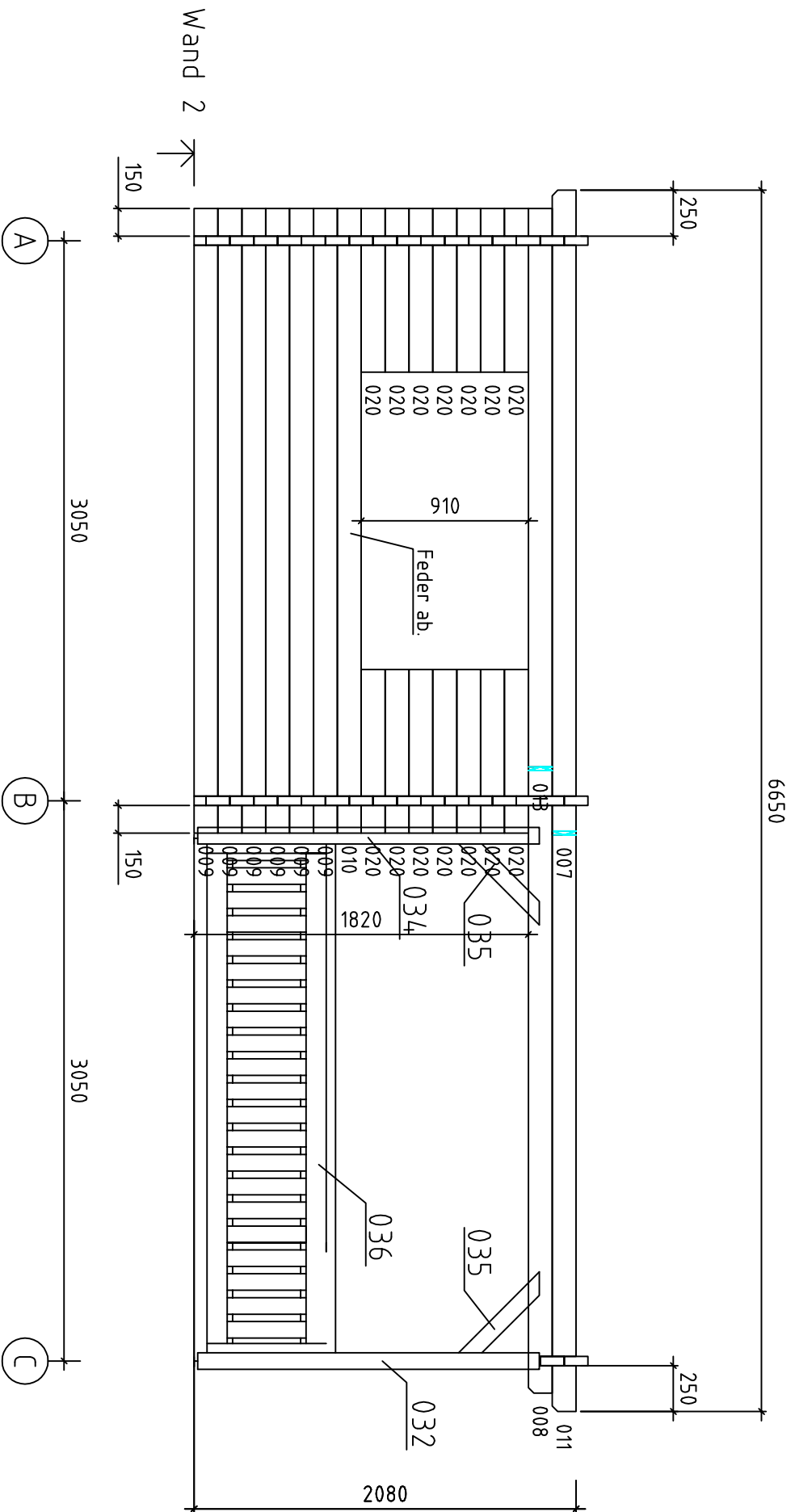

4x3+3 / 50 / 2013

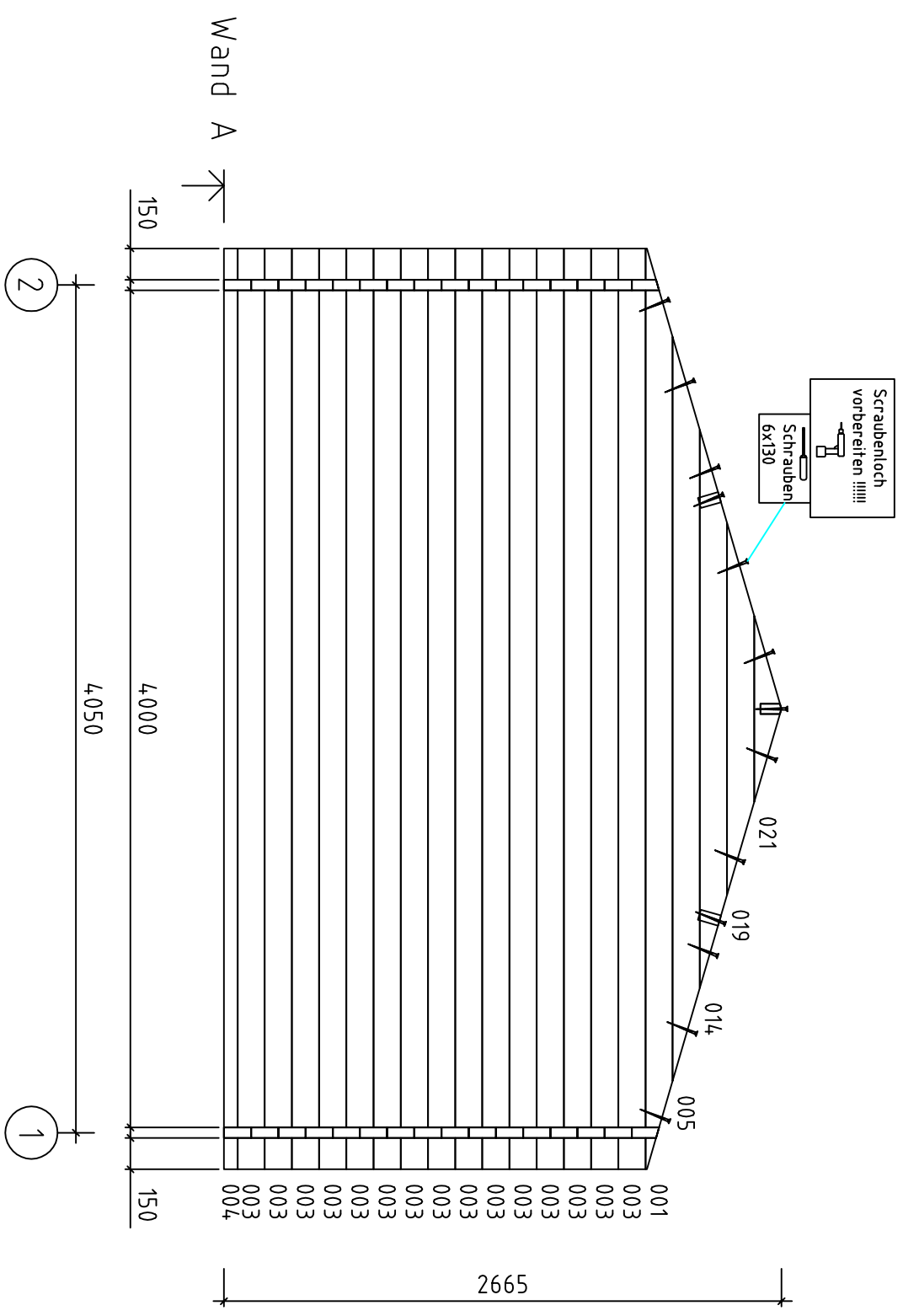

4x3+3 / 50 / 2013

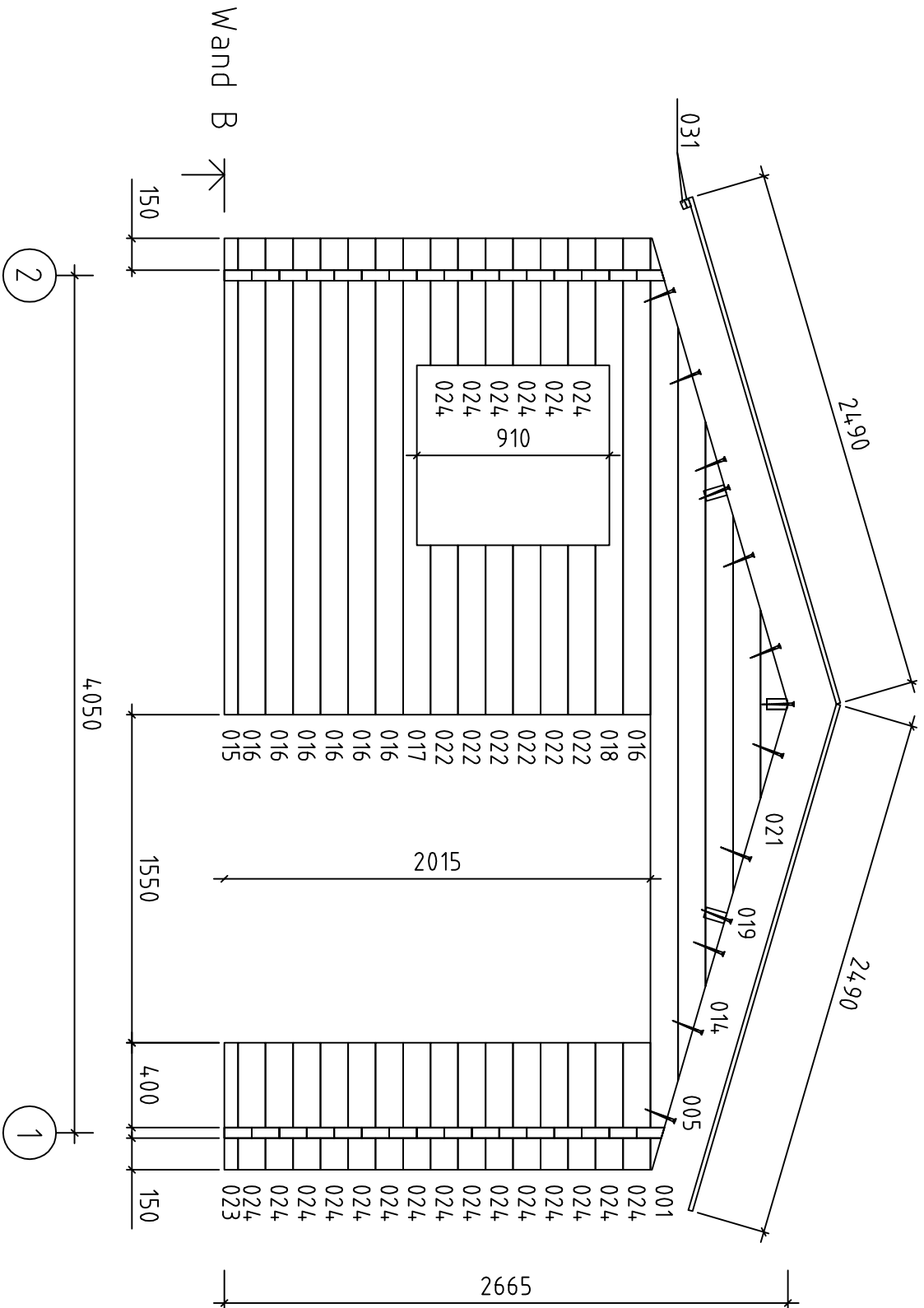

4x3+3 / 50 / 2013

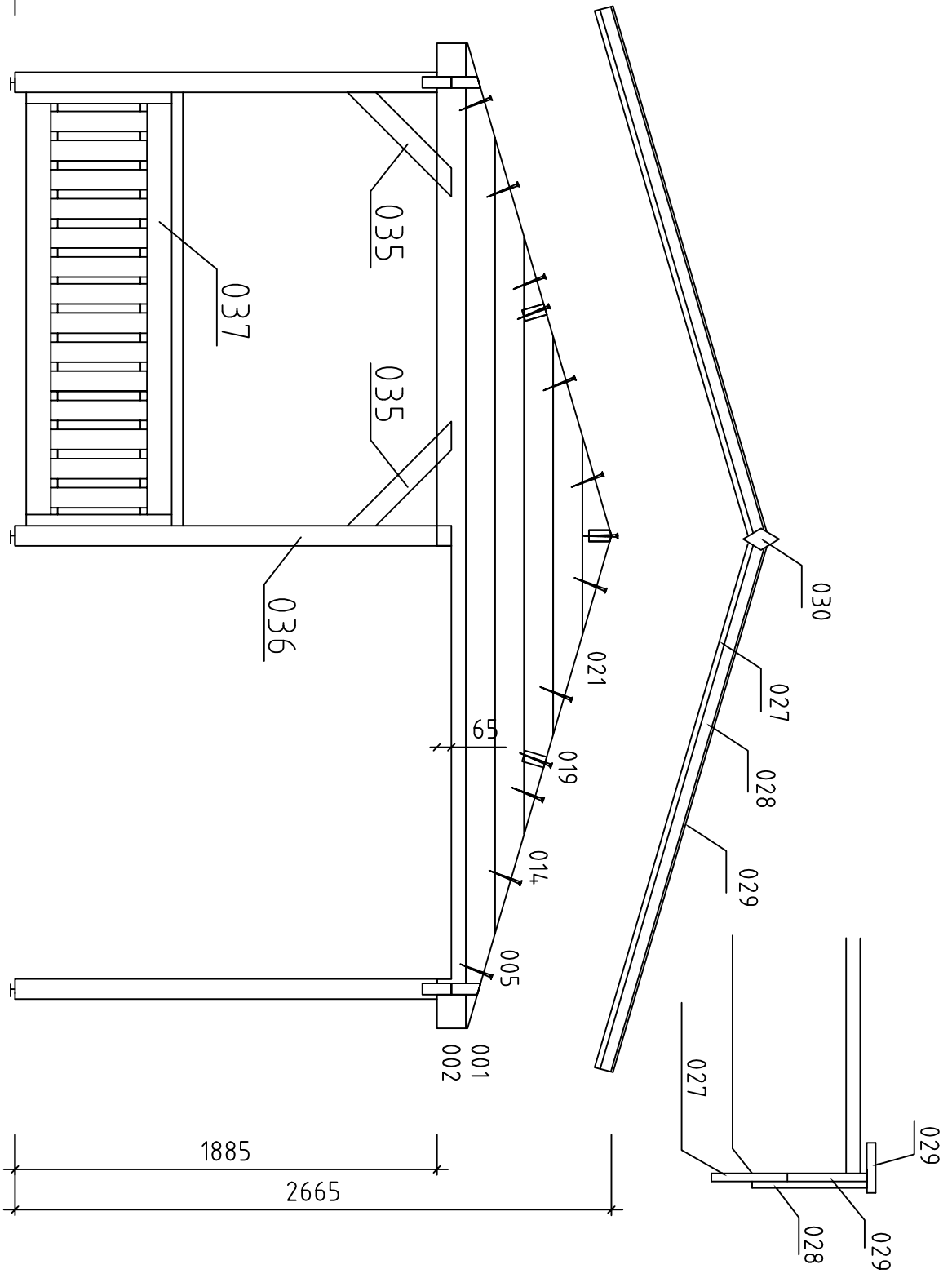

Wand C ↗

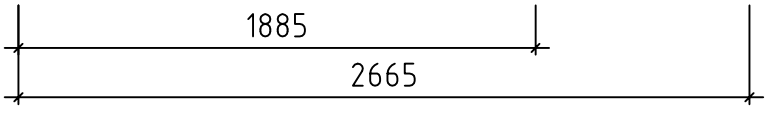
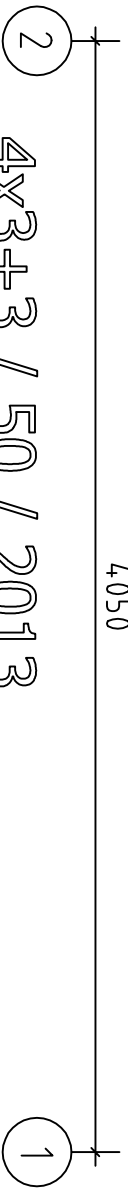
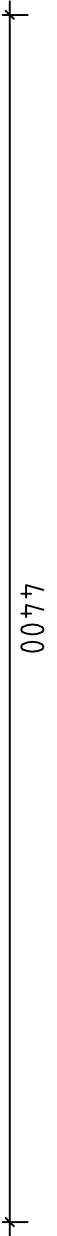

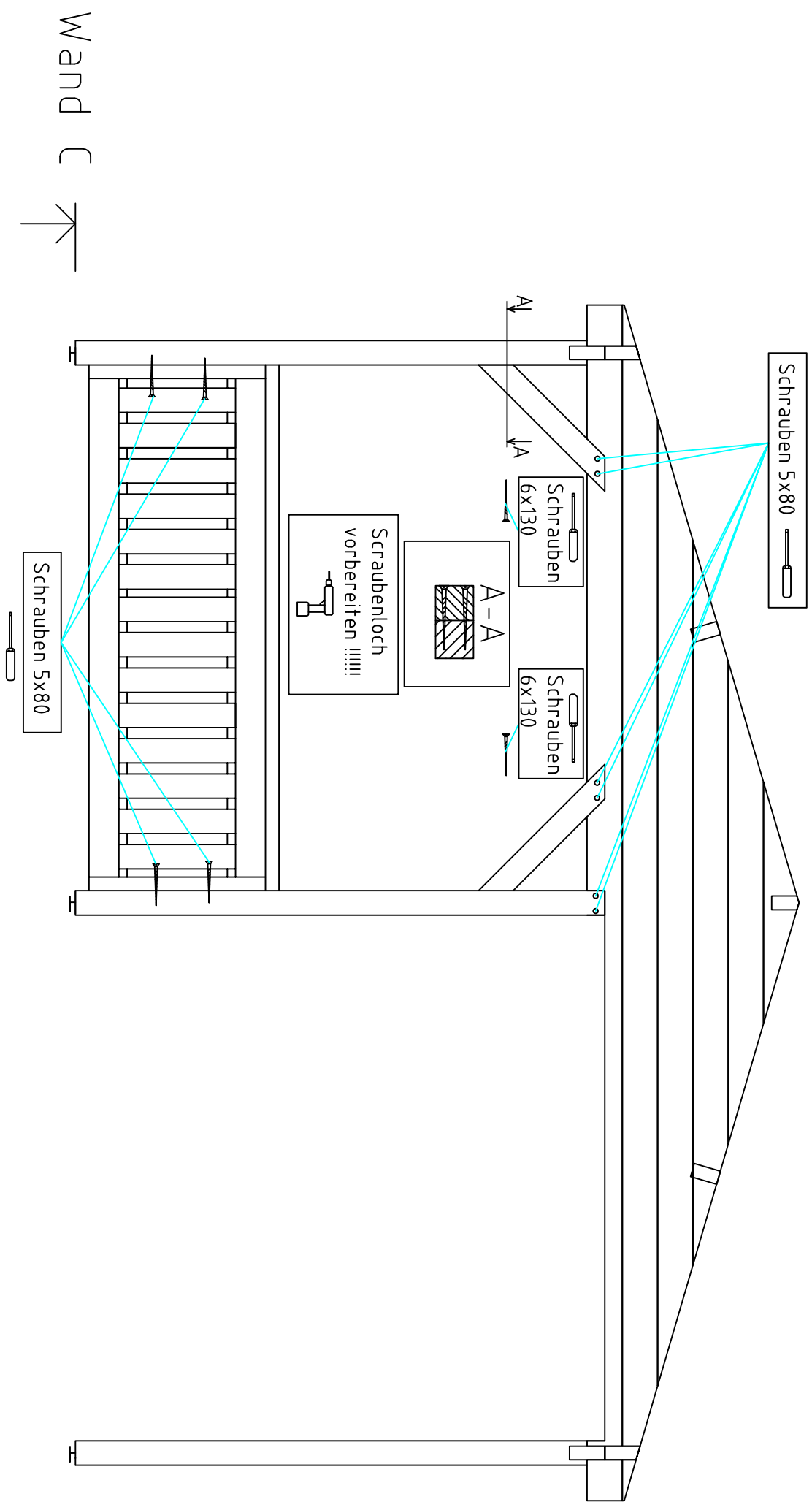

② 4X3+3 / 50 / 2013 ①

Wand 1

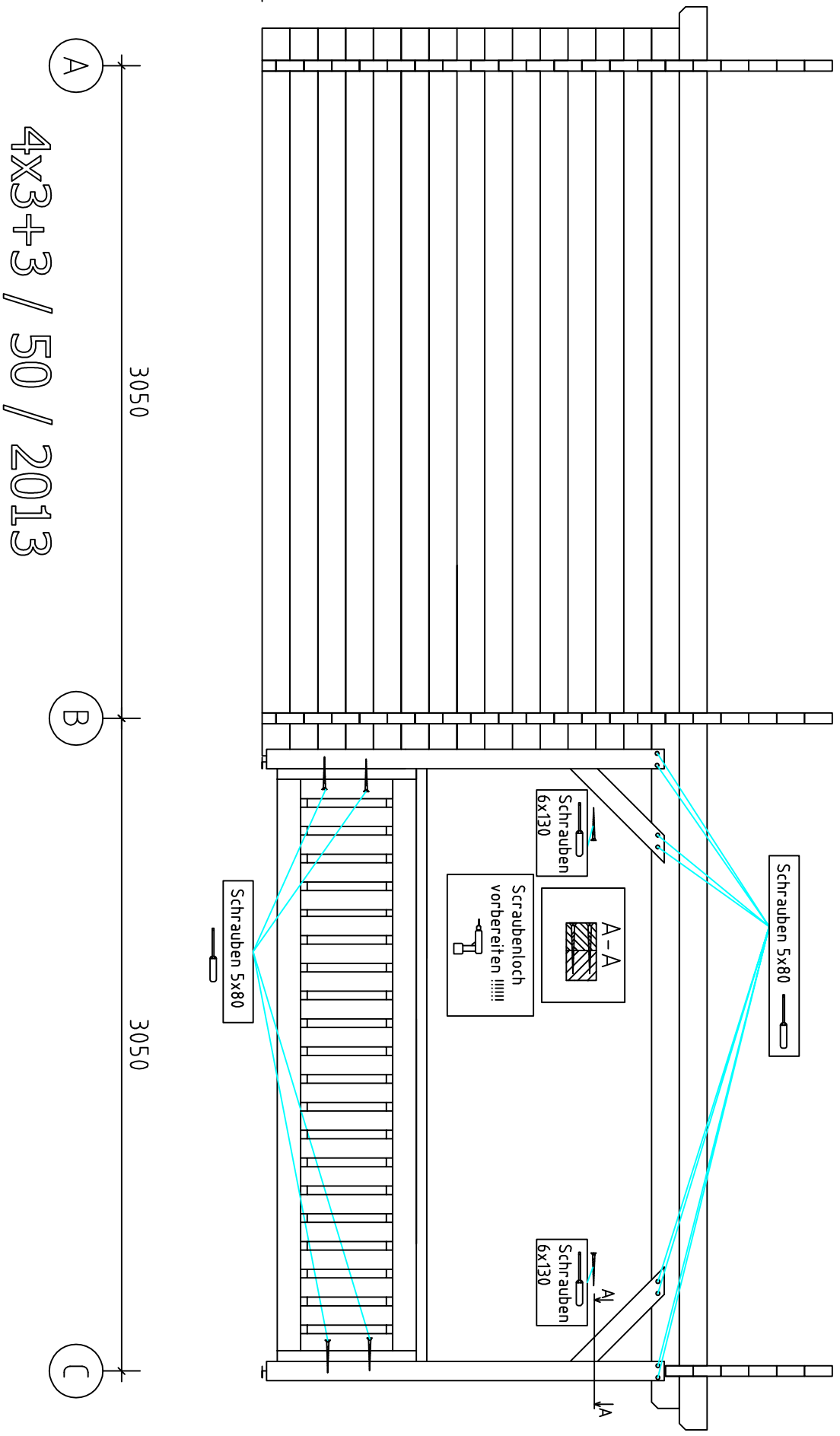

3050

A

B

C

Schrauben 5x80

Schrauben 6x130

A-A
Schraubenloch
vorbereiten iiii

Schrauben 6x130

Schrauben 5x80

3050

3050

4x3+3 / 50 / 2013

Wand 2

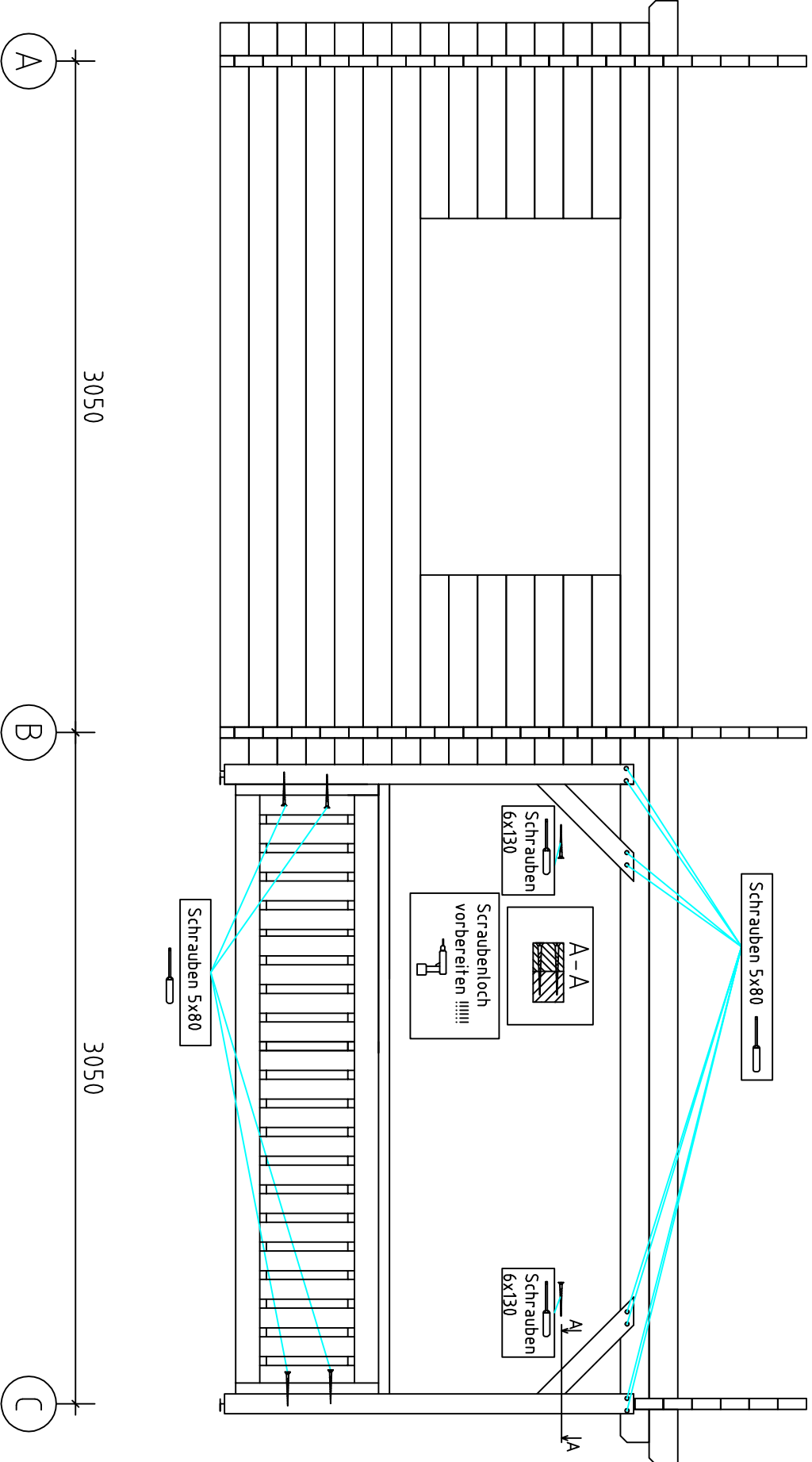









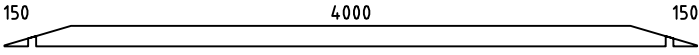
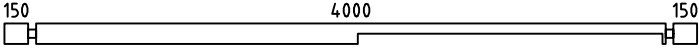
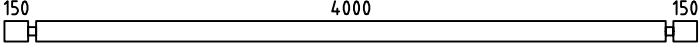
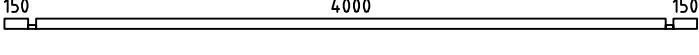
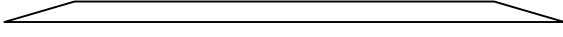
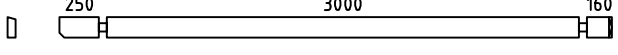
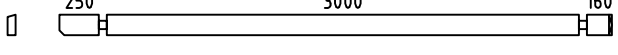
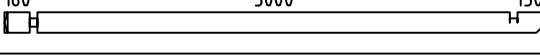
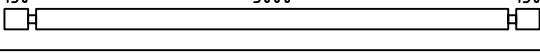
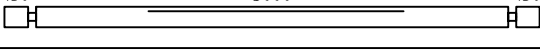
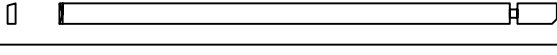
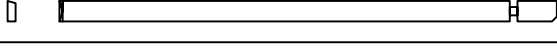
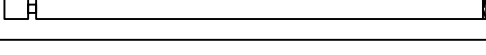
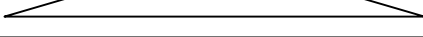
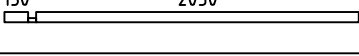
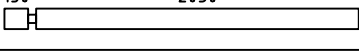
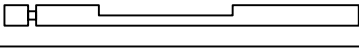
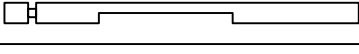
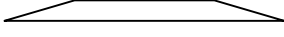
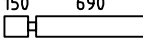
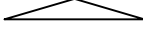
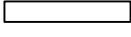
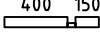
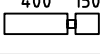

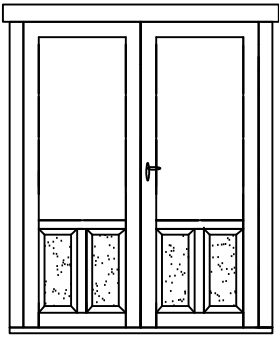
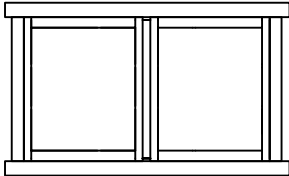
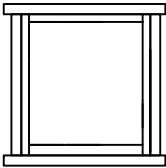

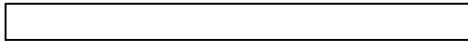
4x3+3 / 50 / 2013

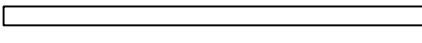
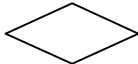
A

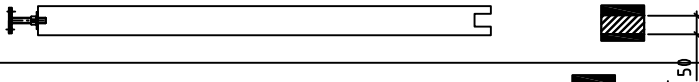
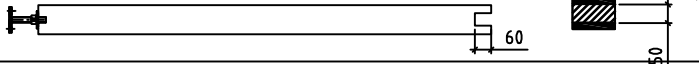
B

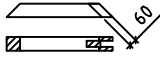
C

Pos	4x3+3 / 50 / 2013	ST	F (mm)	L (mm)
001		3	50x130	4400
002		1	50x130	4400
003		15	50x130	4400
004		1	50x65	4400
005		3	50x130	3556
006		1	50x130	3510
007		1	50x130	3510
008		2	50x130	3410
009		20	50x130	3400
010	 Feder ab	1	50x130	3400
011		1	50x130	3160
012		1	50x130	3160
013		2	50x130	3060
014		3	50x130	2667
015		1	50x65	2250
016		7	50x130	2250
017		1	50x130	2250
018		1	50x130	2250
019		3	50x130	1778
020		14	50x130	890
021		3	50x130	889
022		6	50x130	800
023		1	50x65	600
024		21	50x130	600
Kood	Materjal	File	trükk.dwg	Leht 1/2

Pos	4x3+3 / 50 / 2013		ST	F (mm)	L (mm)				
U155S	Tür 1550x2015 Deur Door		1						
		<table border="1"> <tr> <td>Iso</td> <td>1200x544= 2st.</td> </tr> <tr> <td></td> <td>kotike 1 kmpl.</td> </tr> </table>	Iso	1200x544= 2st.		kotike 1 kmpl.			
Iso	1200x544= 2st.								
	kotike 1 kmpl.								
F1	Fenster 1620x910 Raam Window		1R						
		<table border="1"> <tr> <td>Iso</td> <td>629x657 2st.</td> </tr> </table>	Iso	629x657 2st.					
Iso	629x657 2st.								
F2	Fenster 850x910 Raam Window		1R						
		<table border="1"> <tr> <td>Iso</td> <td>629x657 1st.</td> </tr> </table>	Iso	629x657 1st.					
Iso	629x657 1st.								
026	Dachbrettern Dakplanken Roofboard's		150	90x20	2490				
027	Giebelleiste Gevelanderlijst Frontlist		4	120x20	2650				
028	Giebelleiste Gevelanderlijst Frontlist		4	90x20	2650				
029	Giebeldেকেলে Gevellijst Frontlist		8	60x20	2650				
030	Giebelsegment Gevelsegment Frontsegment		2						
031	Dachpappenleiste Dakshingleslijst Fillet of cardboard		12	40x20	2220				
032	Pfosten Kolom		2	90x90	1820				
033	Column		1	90x90	1880				
034			2	90x90	1820				
035	Träger		6	90x90	655				
036	Barriere		2		2770				
037			1		1935				
038	Schrauben		36	5,0x80					
039	Schrauben		57	6,0x130					
Kood	Materjal	File	trükk.dwg	Leht	2/2				

Doppeltür

Beschlag:

Türklinken mit der Lasche = 1 Kmp.

Schraubeh 5x80mm = 4 St.

Schnepper mit Schlüsseln = 1 Kmp.

Metalblechen (zwei St.) Pos. 5,
befinden sich auf untere oder
obene Türflügelkante.

Schrauben 5x80

Schrauben 5x80

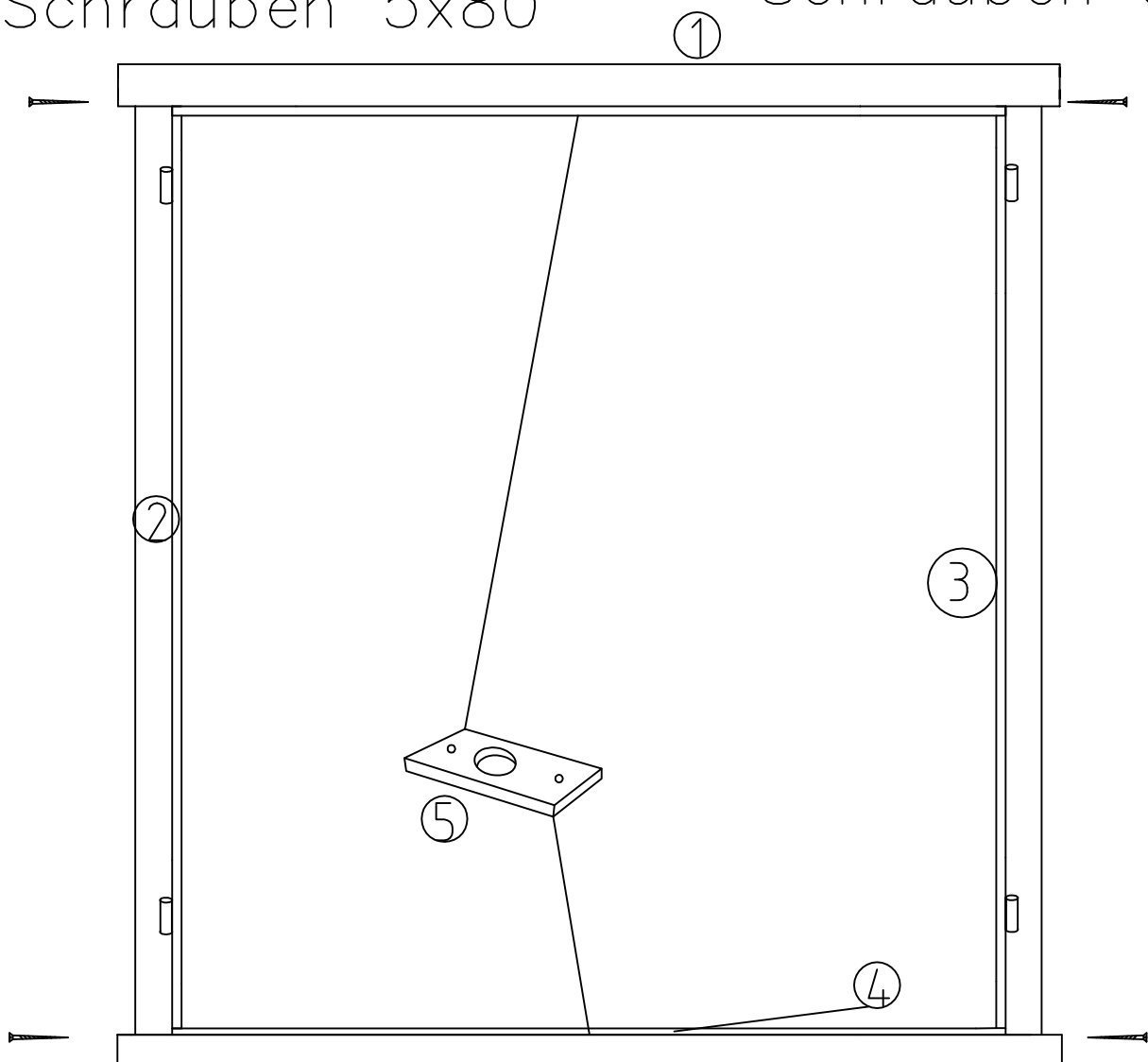

Schrauben 5x80

Schrauben 5x80