

4x3x2 / 50 / 2013

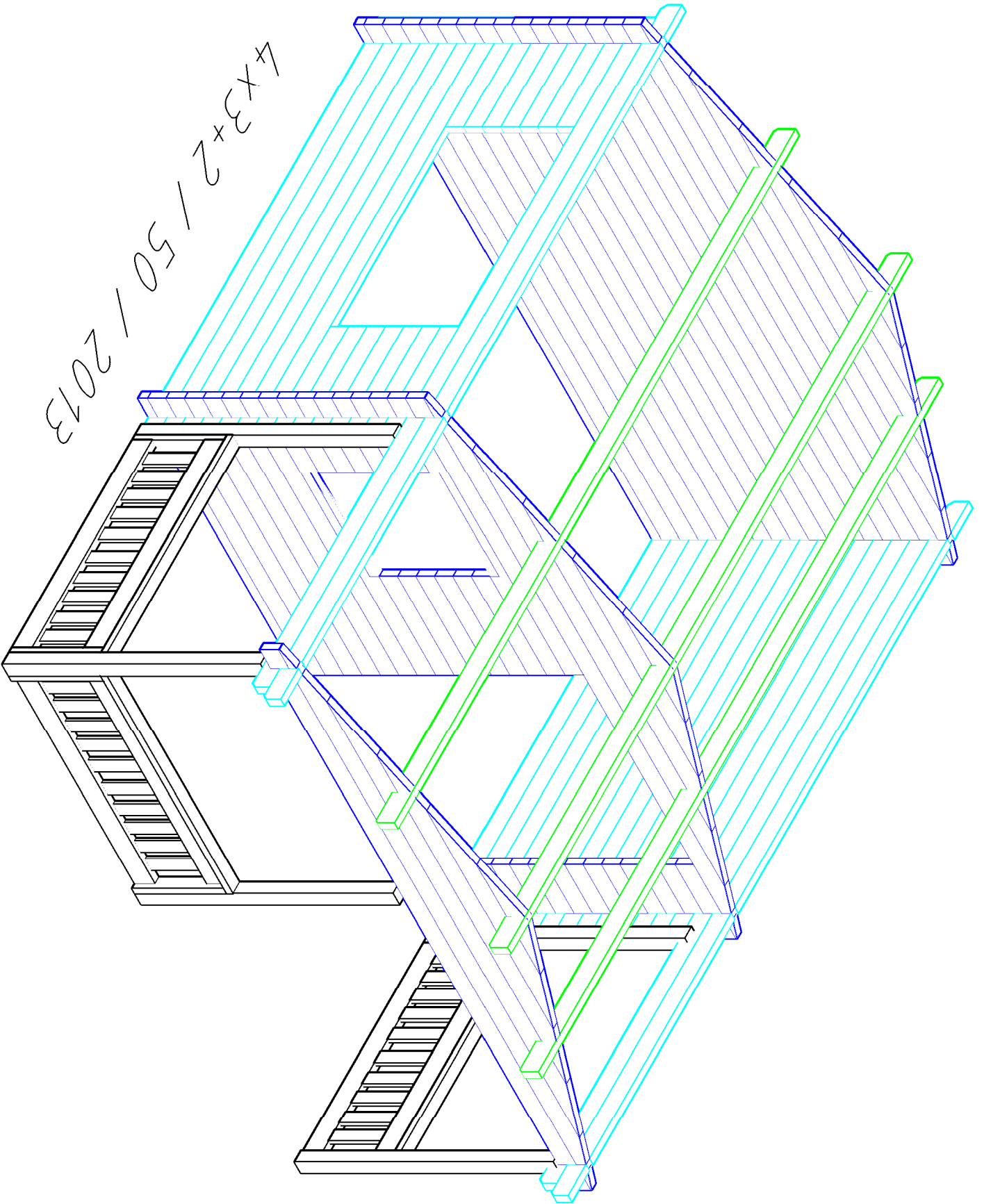

4x3+2 / 50 / 2013

5150

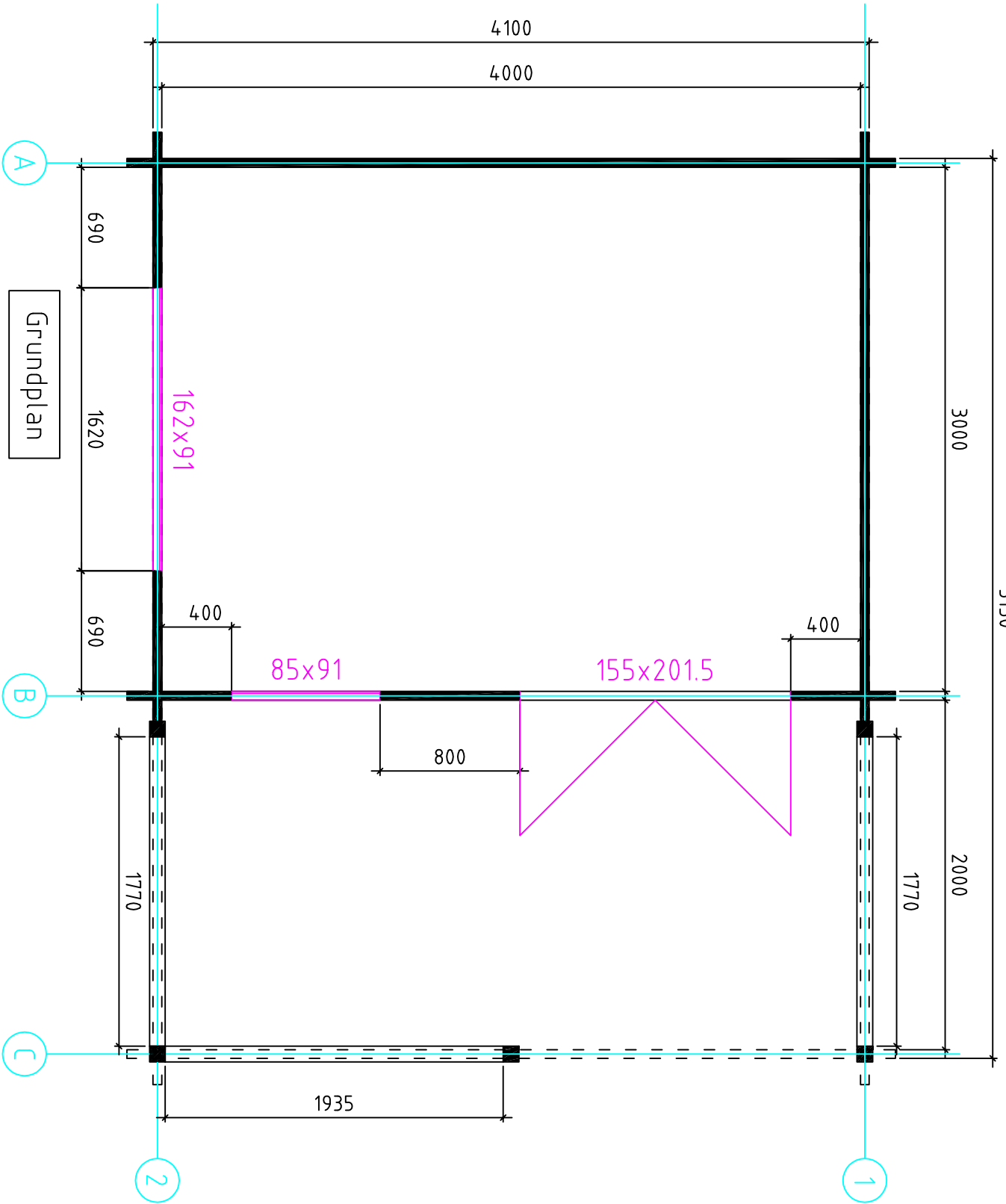

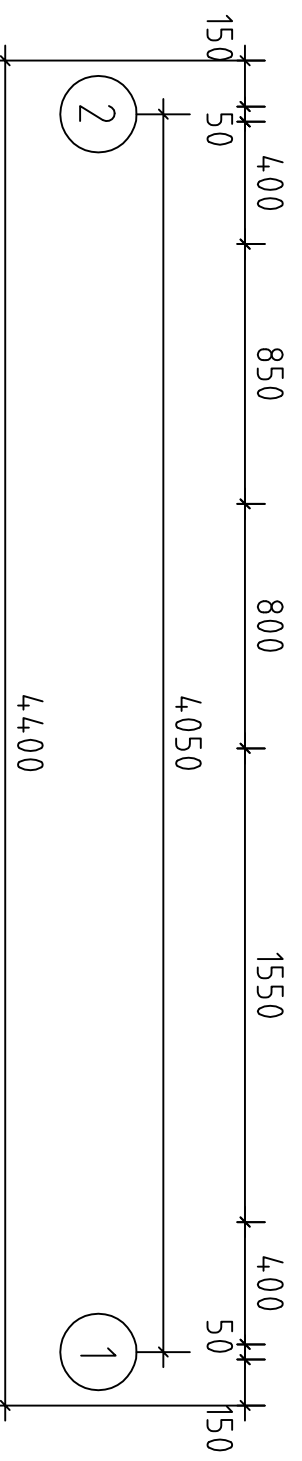
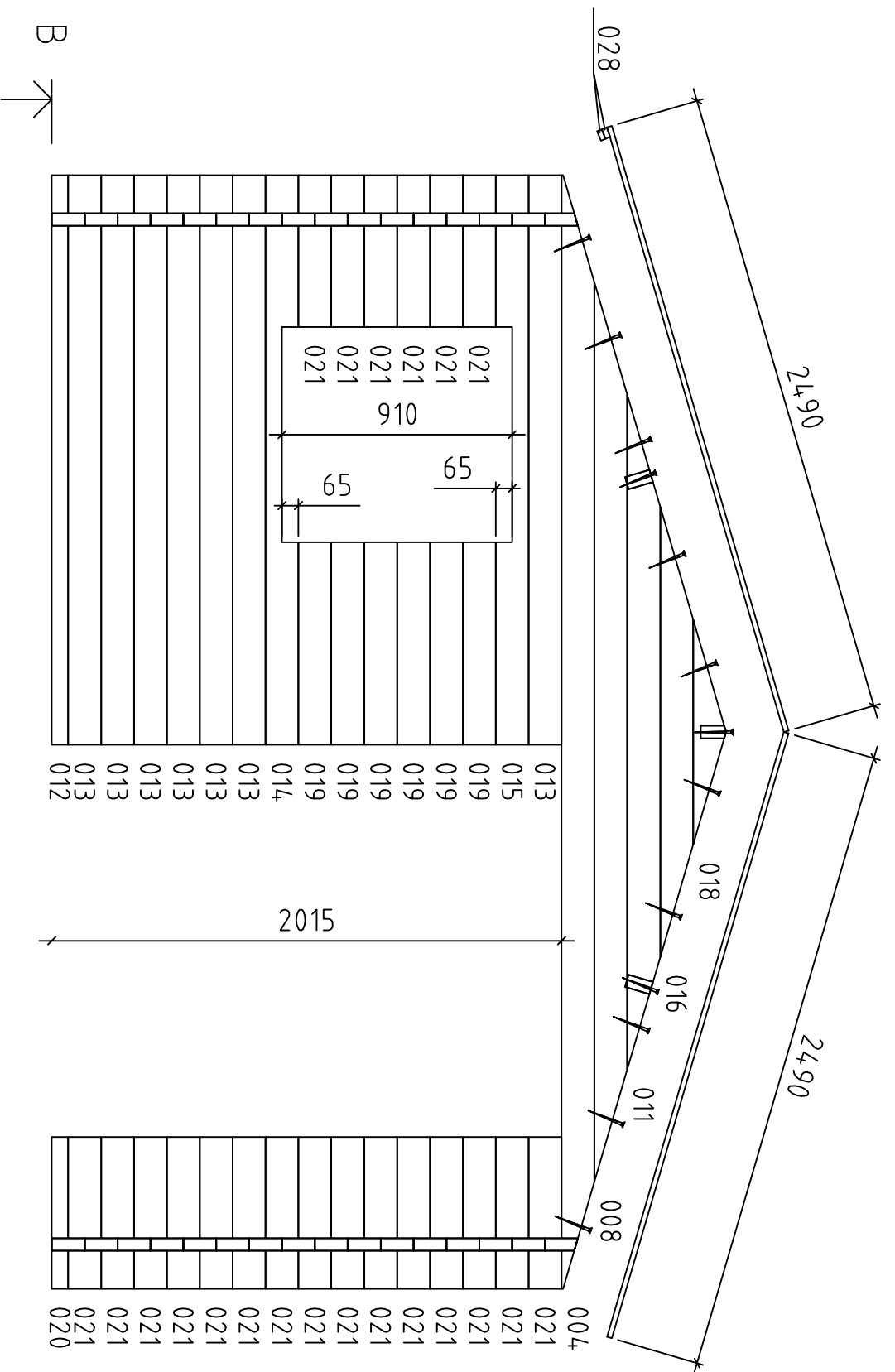

4x3+2 / 50 / 2013

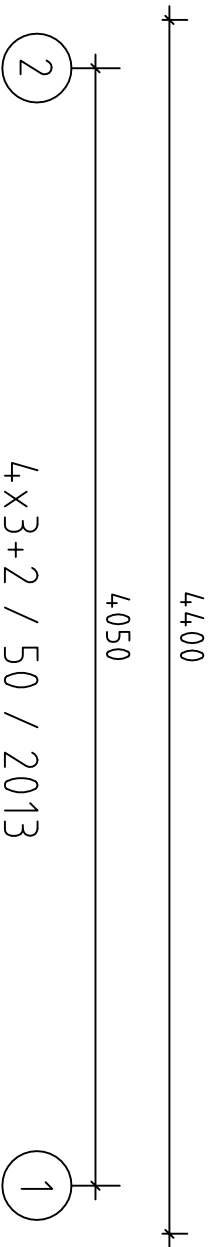
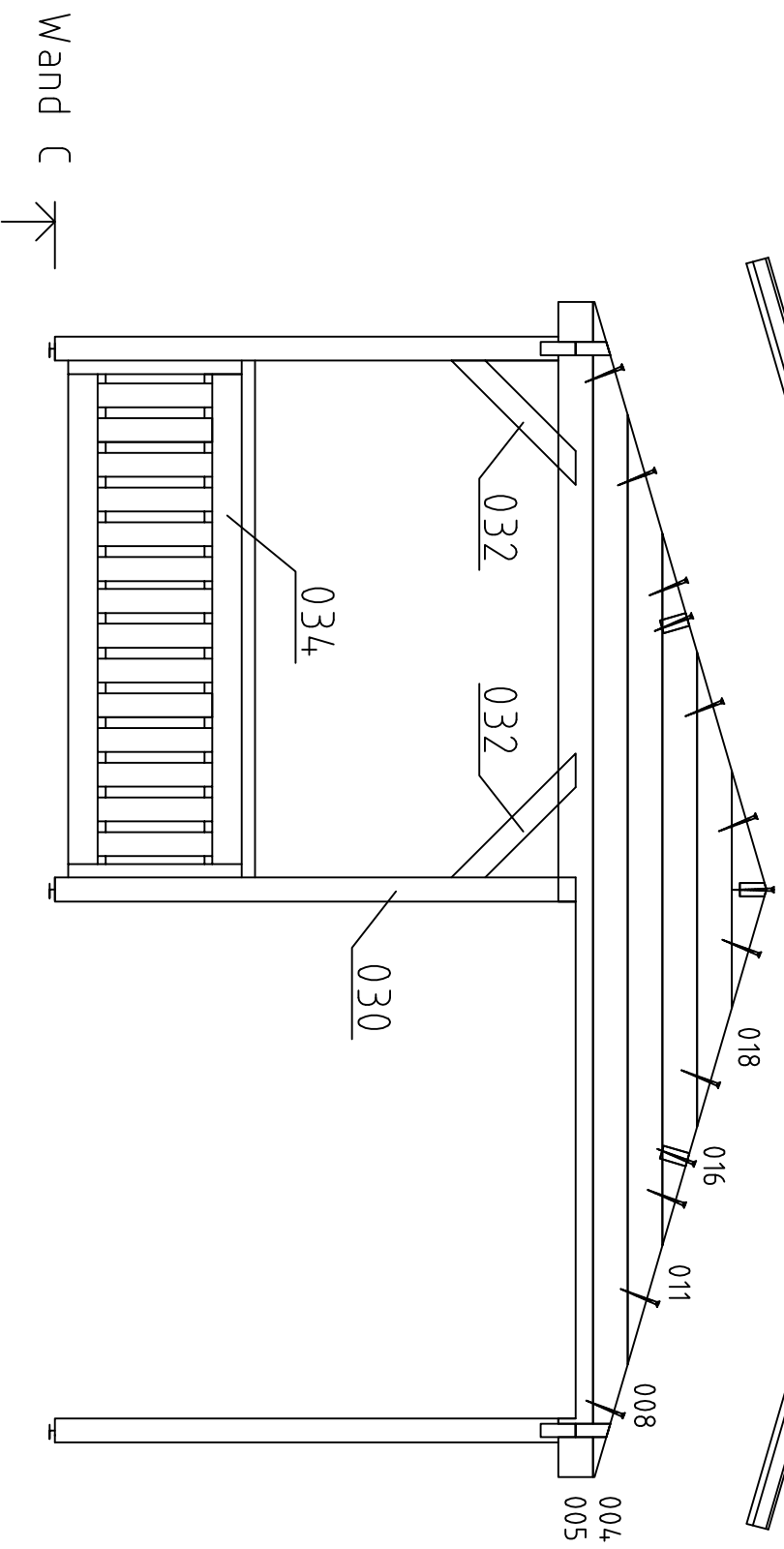
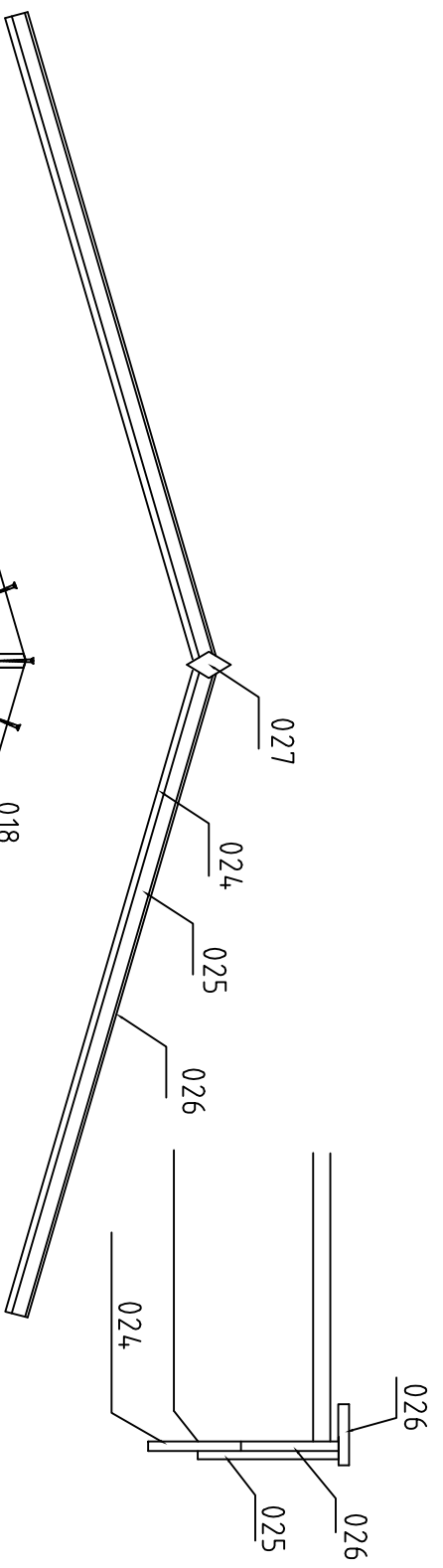

4x3+2 / 50 / 2013

Wand 1 ↗

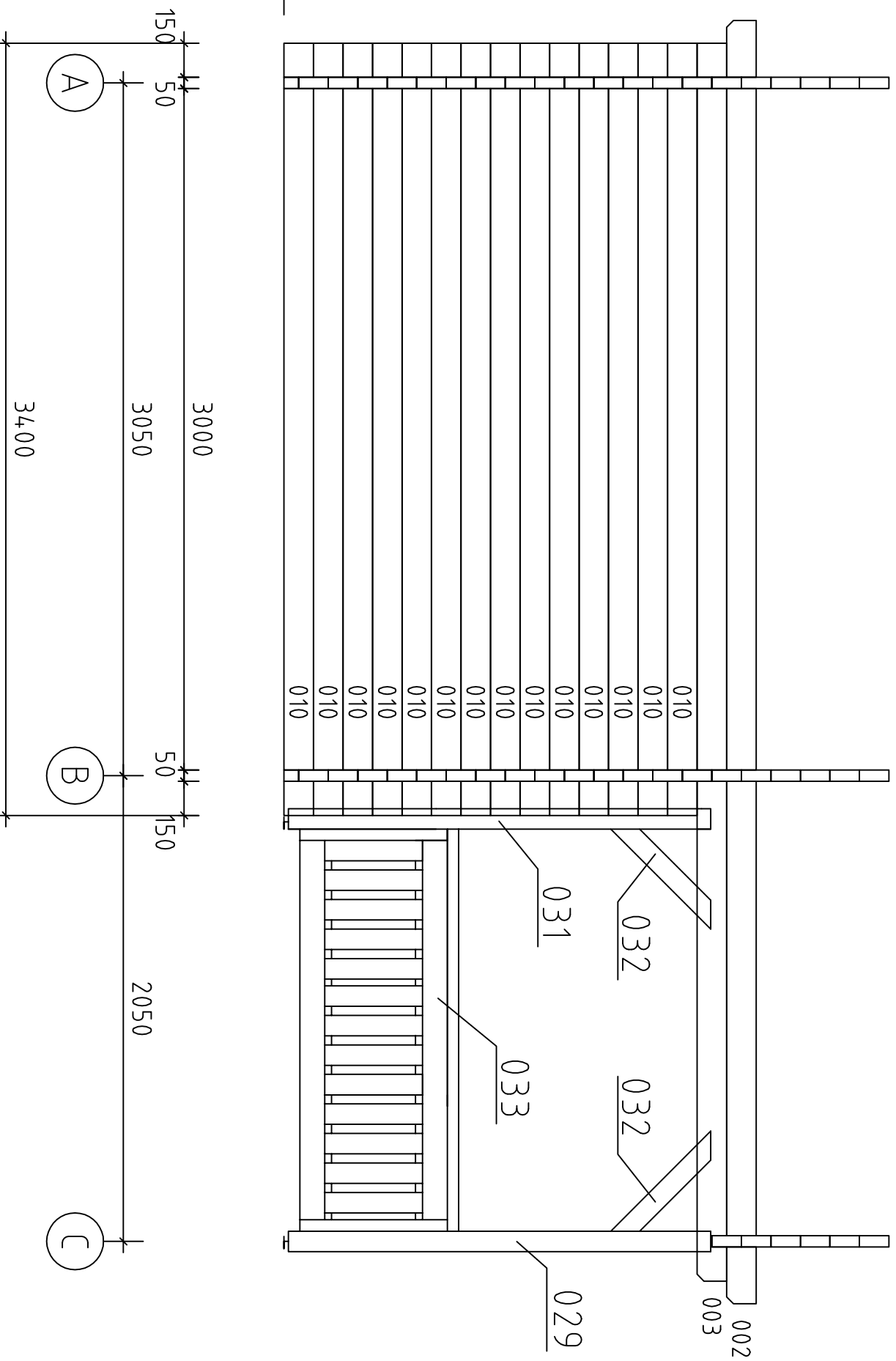

4x3+2 / 50 / 2013

Wand 2 ↗

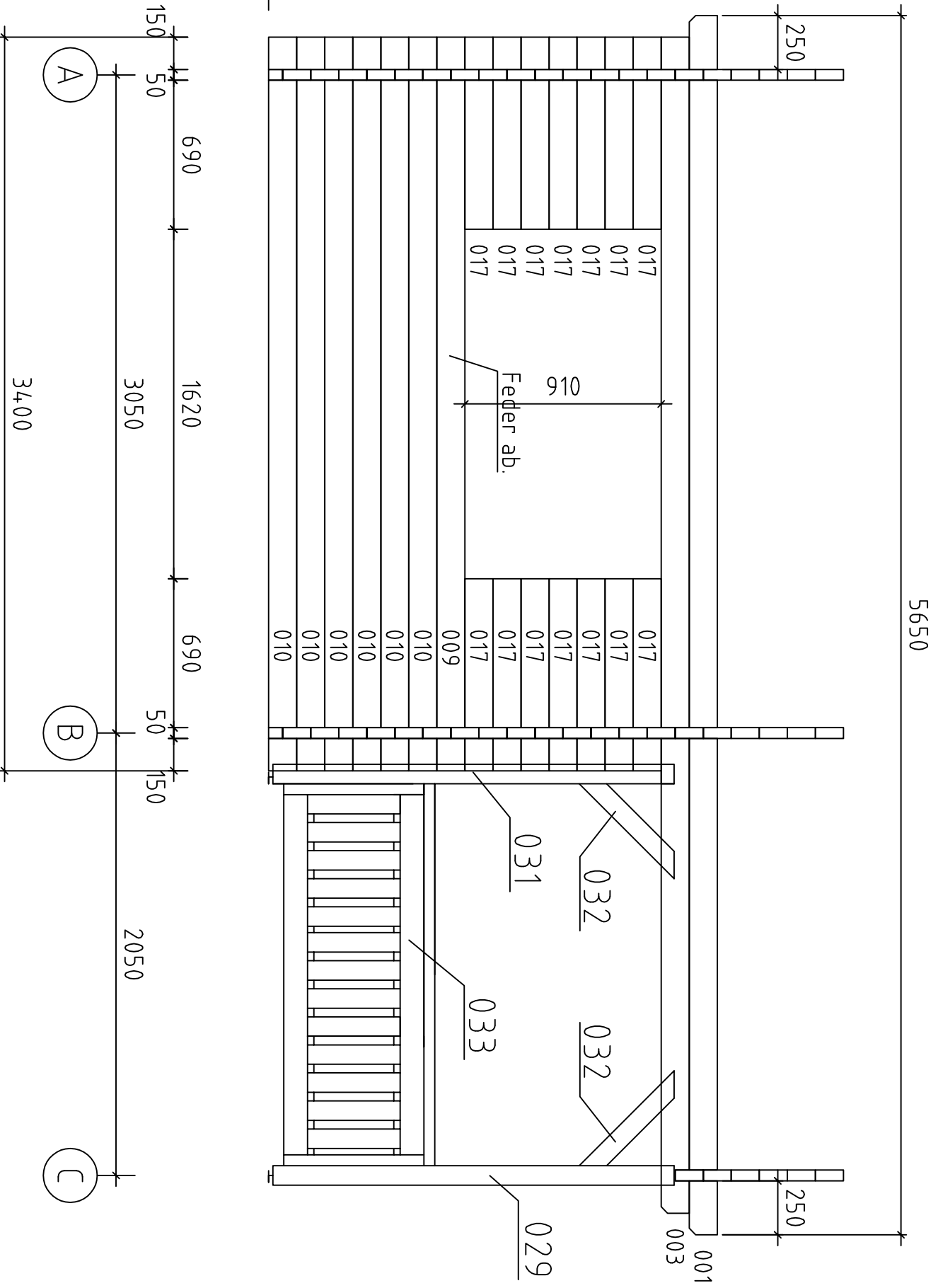

4x3+2 / 50 / 2013

Wand C ↗

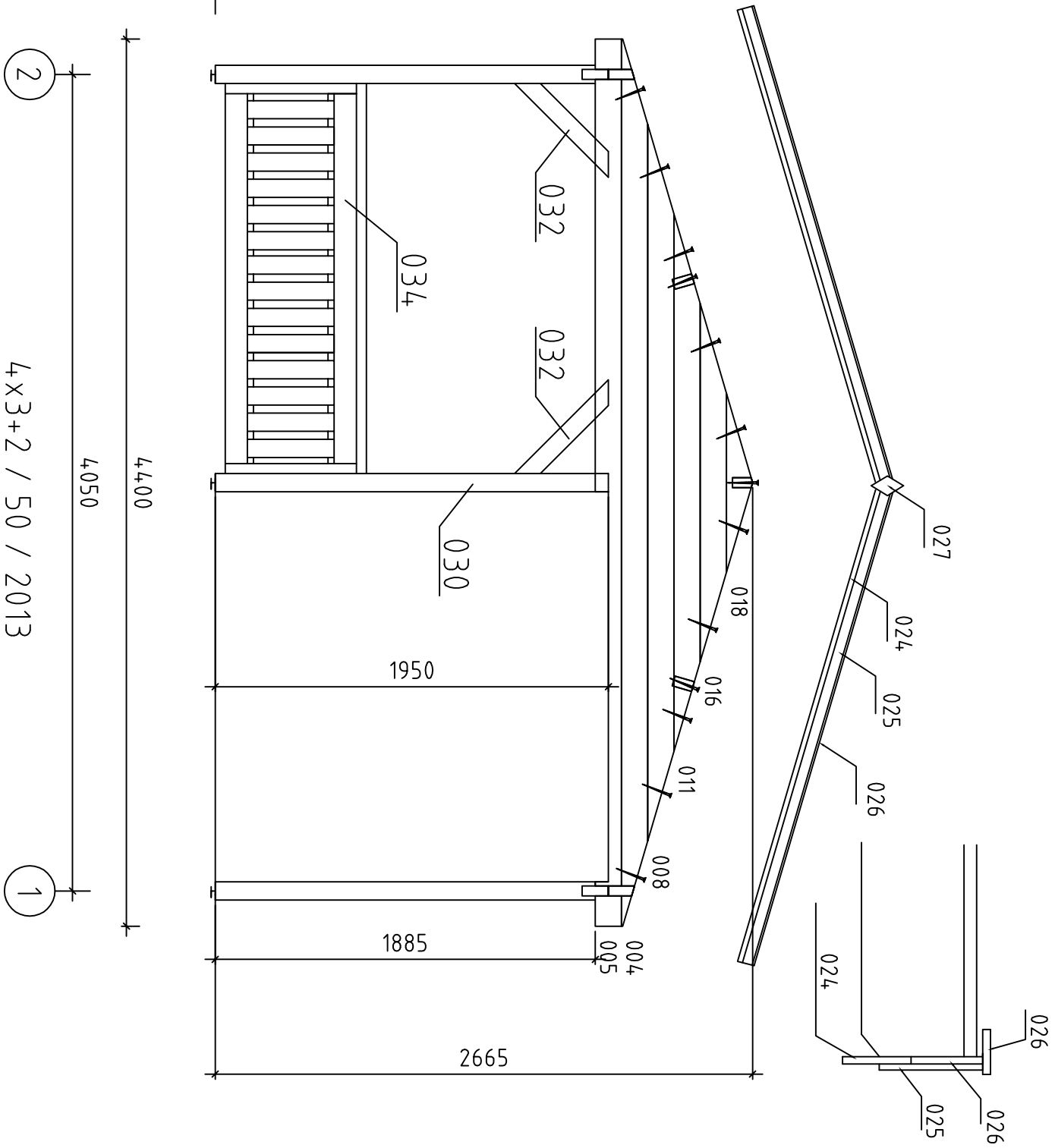

2

4x3+2 / 50 / 2013

1

Wand 2 ↗

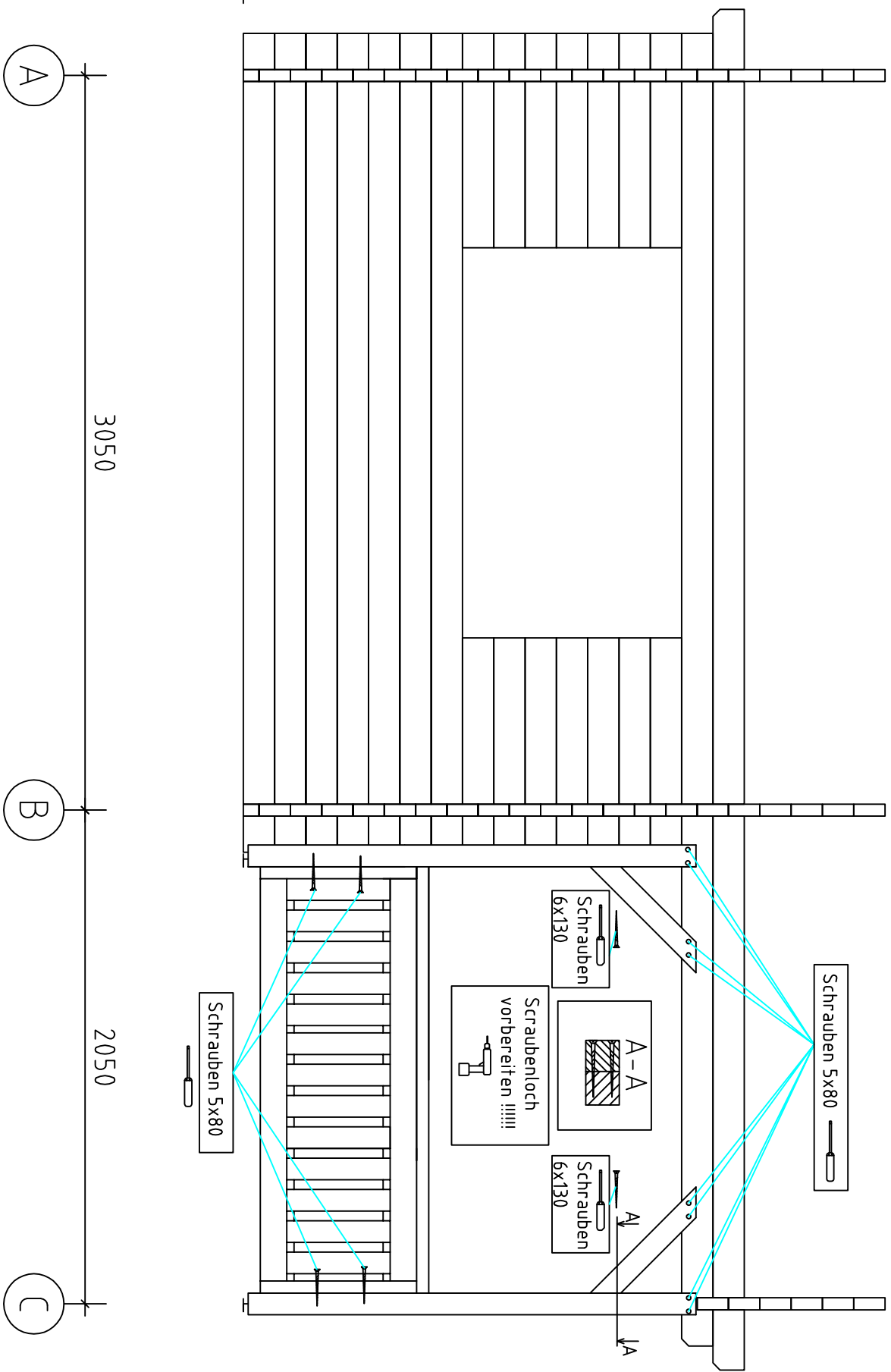

4x3+2 / 50 / 2013

Wand 1

A

3050

B

2050

C

4x3+2 / 50 / 2013

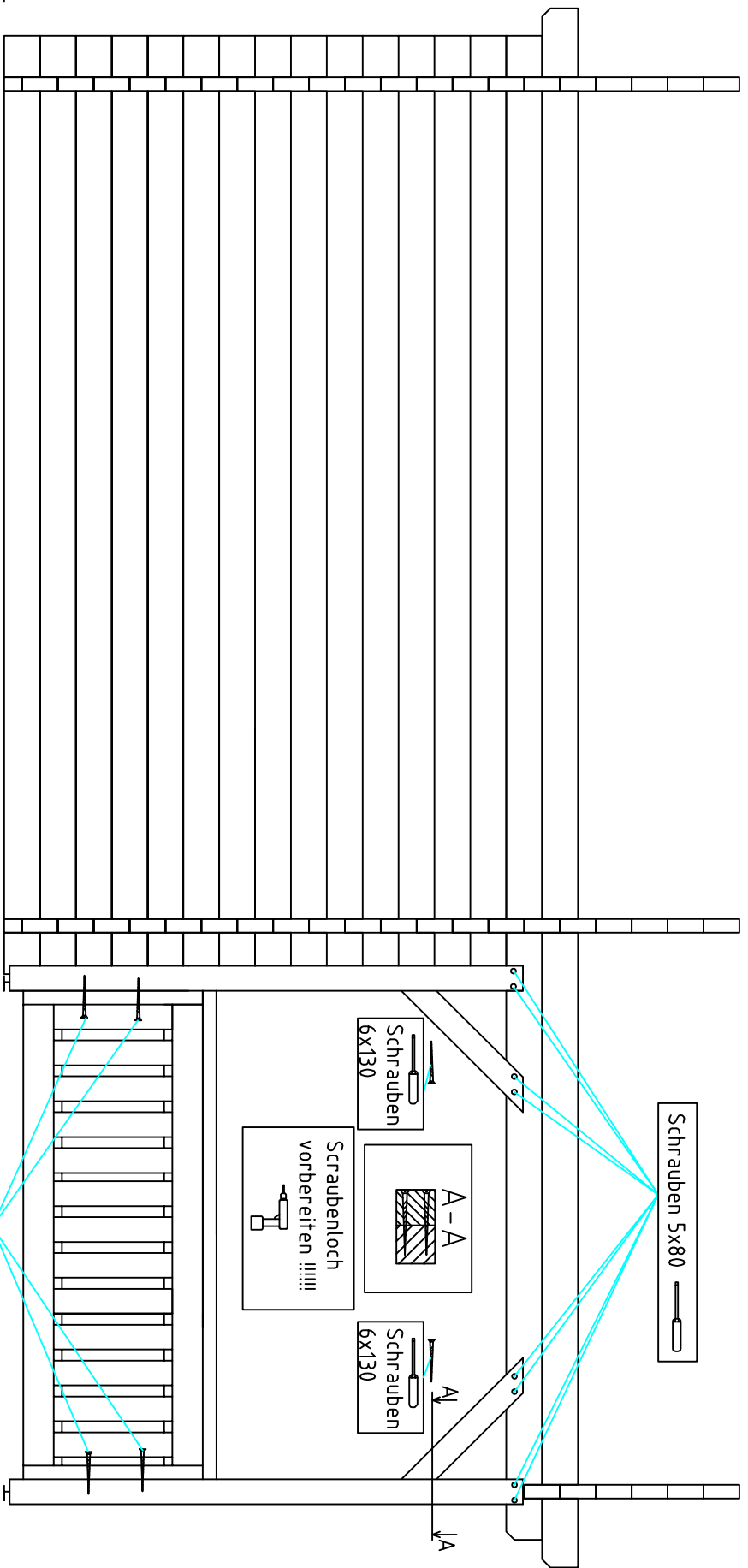

Schrauben 5x80



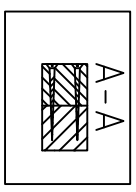







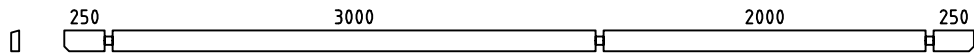
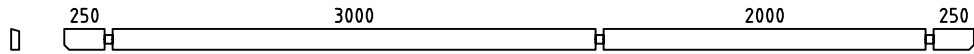
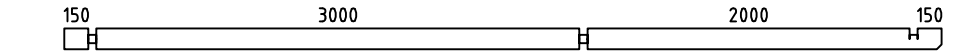
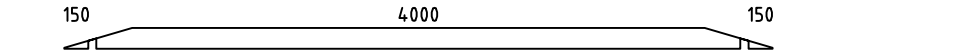
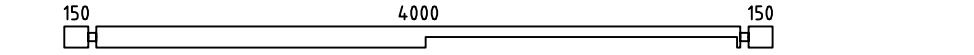
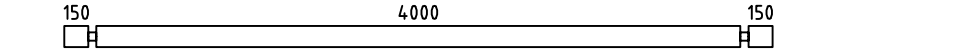
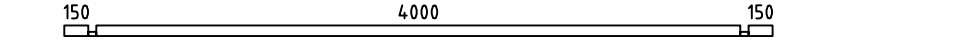
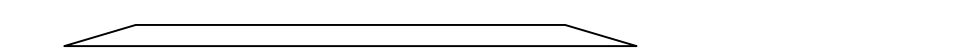
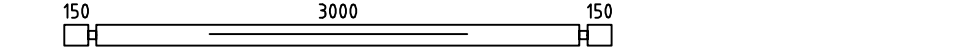
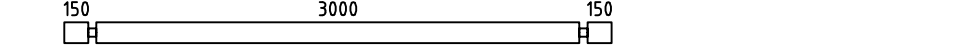
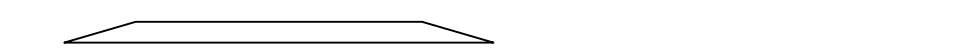

Schrauben 6x130







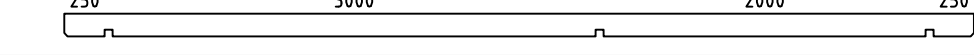
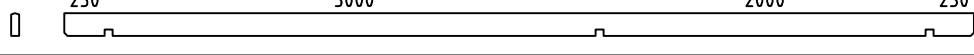
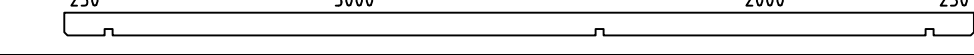

Schraubenloch vorbereiten

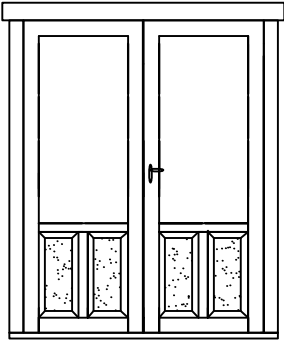
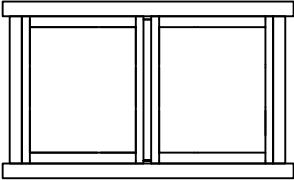
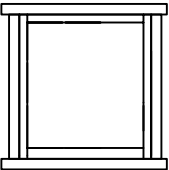
Schrauben 6x130

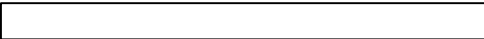
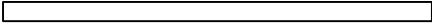
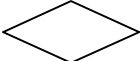
Schrauben 5x80

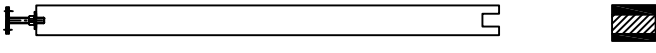
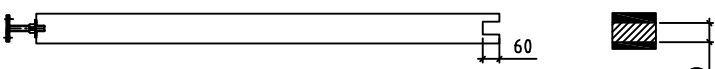
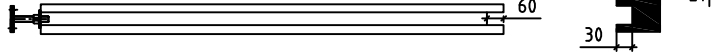
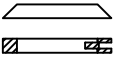
Pos	4x3+2 / 50 / 2013	ST	F (mm)	L (mm)
001		1	50x130	5650
002		1	50x130	5650
003		2	50x130	5450
004		3	50x130	4400
005		1	50x130	4400
006		15	50x130	4400
007		1	50x65	4400
008		3	50x130	3556
009		1	50x130	3400
010		20	50x130	3400
011		3	50x130	2667
012		1	50x65	2250
013		7	50x130	2250
014		1	50x130	2250
015		1	50x130	2250
016		3	50x130	1778
017		14	50x130	890
018		3	50x130	889
019		6	50x130	800
020		1	50x65	600
021		21	50x130	600
PR1		1	50x140	5650
PR2		1	50x140	5650
PR3		1	50x140	5650
022	Abdeckleiste Afdeklijst Finishinglist 		20x40	6m

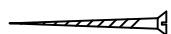
Pos	4x3+2 / 50 / 2013		ST	F (mm)	L (mm)
U155S	Tür 1550x2015 Deur Door		Iso	1200x544= 2st. kotike 1 kmpl.	
F1	Fenster 1620x910 Raam Window		Iso	629x657 2st.	
F2	Fenster 850x910 Raam Window		Iso	629x657 1st.	
023	Dachbrettern Dakplanken Roofboard's		130	90x20	2490
024	Giebelleiste Gevelanderlijst Frontlist		4	110x20	2650
025	Giebelleiste Gevelanderlijst Frontlist		4	90x20	2650
026	Giebeldেকেleiste Gevellijst Frontlist		8	60x20	2650
027	Giebelsegment Gevelsegment Frontsegment		2		
028	Dachpappenleiste Dakshingleslijst Fillet of cardboard		12	40x20	1890
029	Pfosten Kolom		2	90x90	1820
030	Column		1	90x90	1880
031			2	90x90	1820
032	Träger		6	90x90	655
033	Barriere		2		1770
034			1		1935
035	Schrauben 		36	5,0x80	
036	Schrauben 		54	6,0x130	

Doppeltür

Beschlag:

Türklinen mit der Lasche = 1 Kmp.

Schraube 5x80mm = 4 St.

Schnepper mit Schlüssel = 1 Kmp.

Metallechen (zwei St.) Pos. 5,
befinden sich auf untere oder
obere Türflügelkante.

