

4x4x3 / 50 / 2013

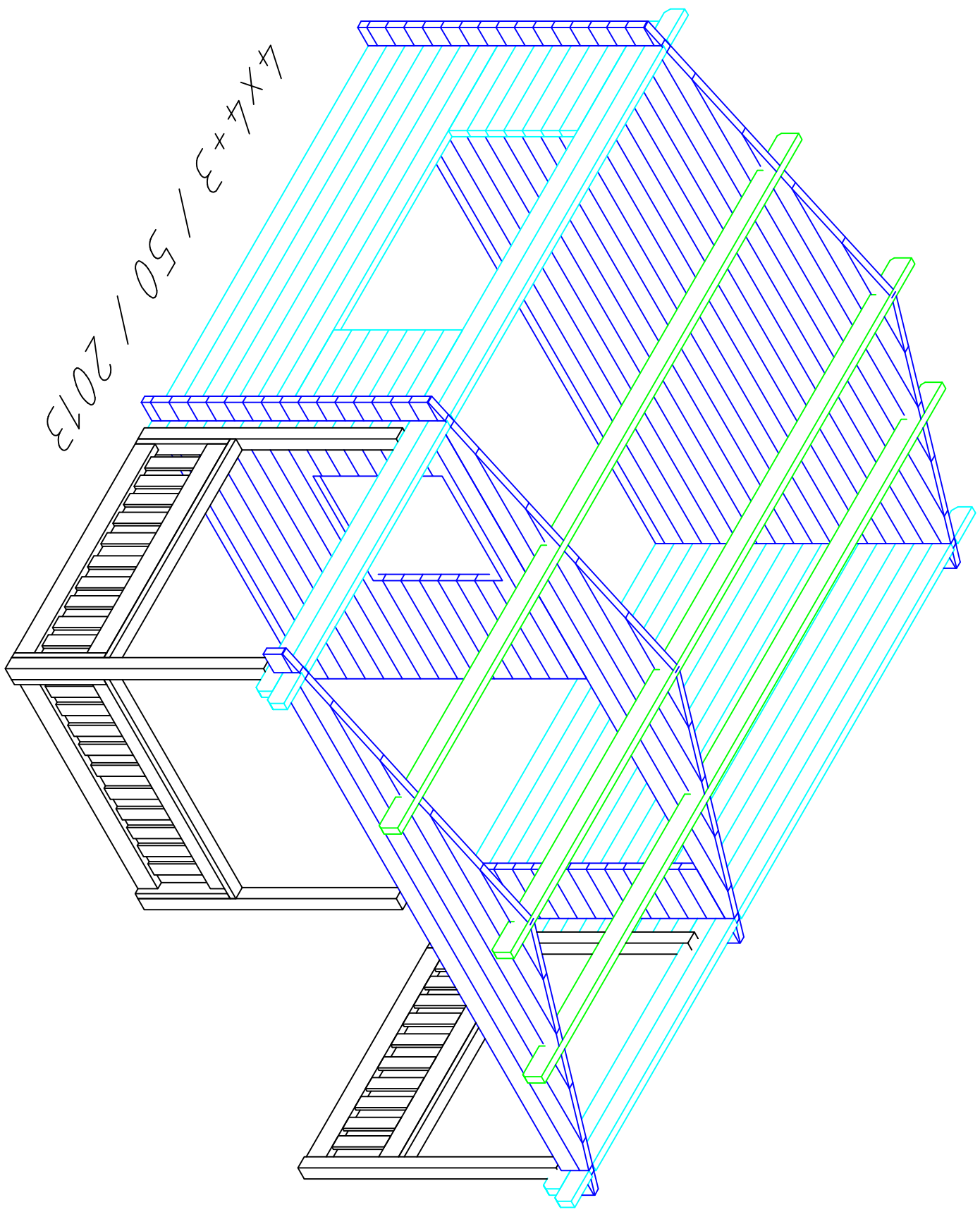

# 4x4+3 / 50 / 2013

7150

4000

3000

2770

1

4100

4000

800

1935

85x91

155x201.5

162x91

1190

1620

1190

400

400

2770

A

B

C

2

Grundplan

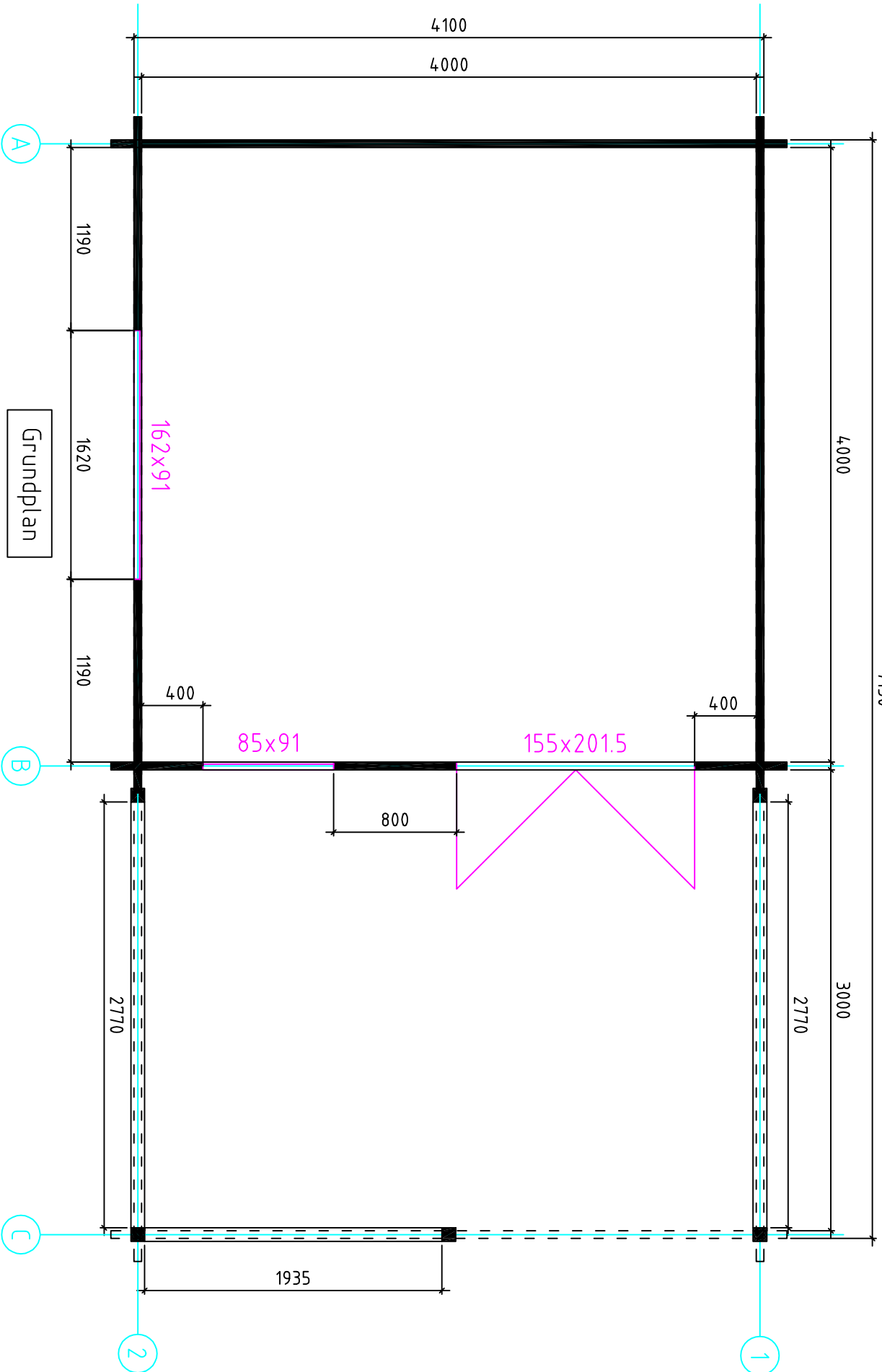



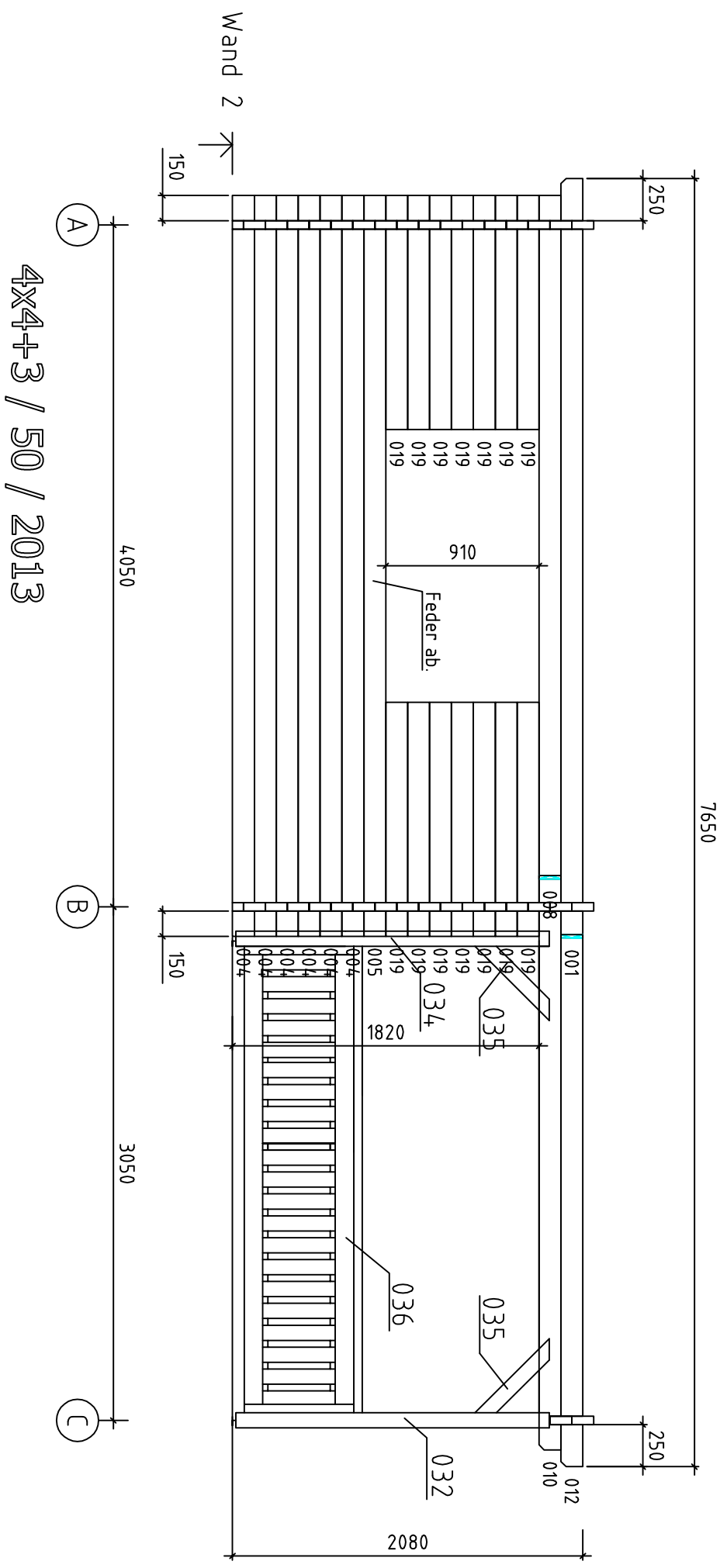

4X4+3 / 50 / 2013



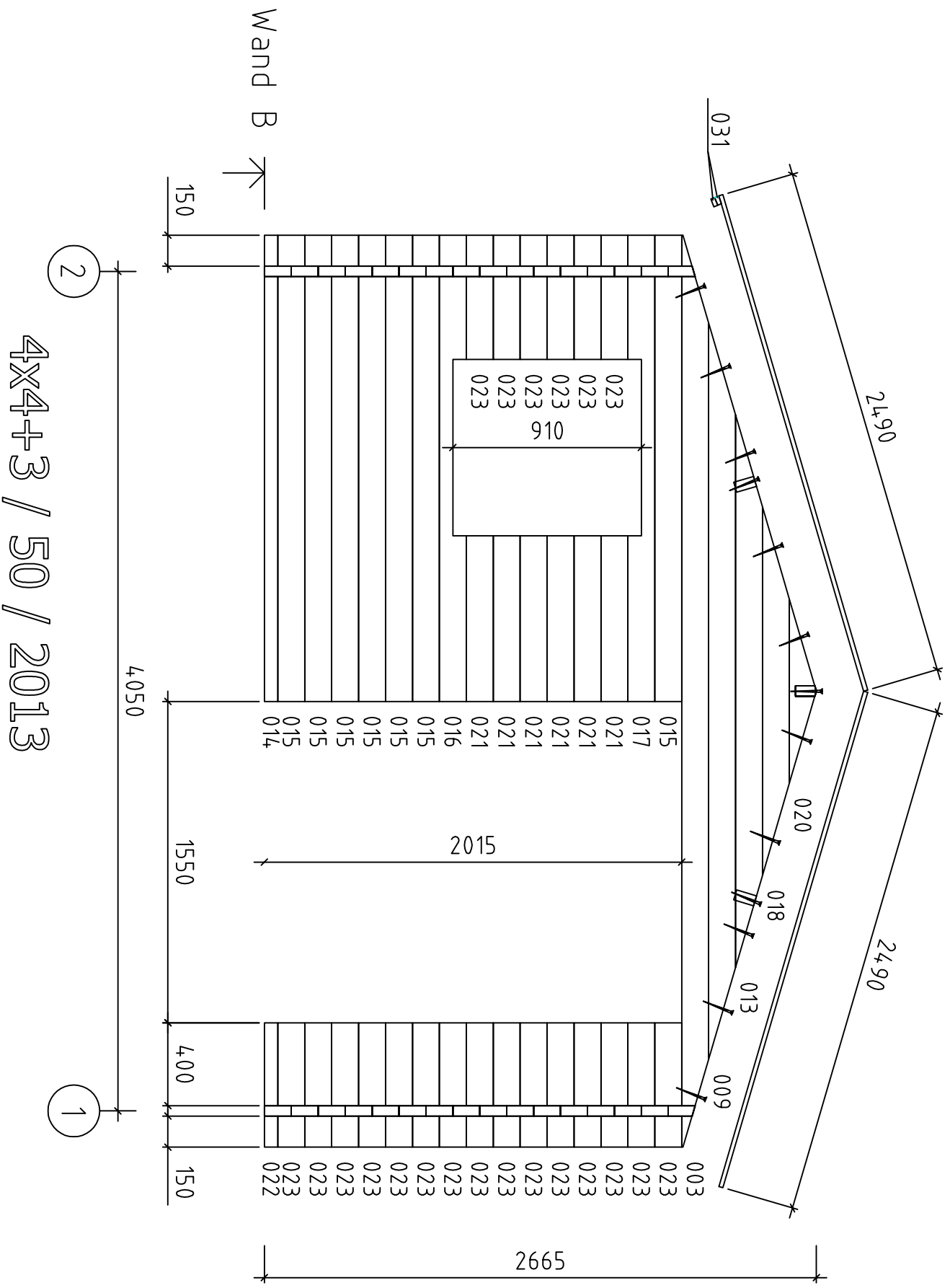





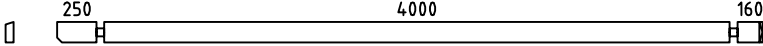
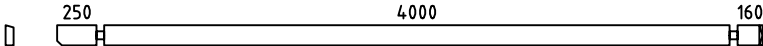
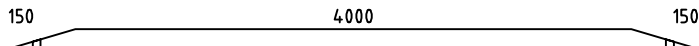
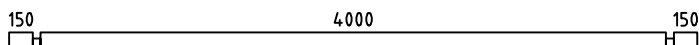
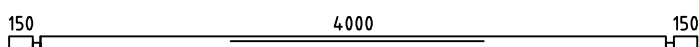
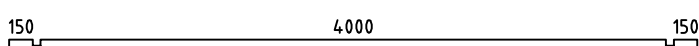
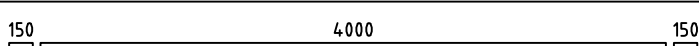
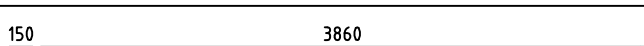
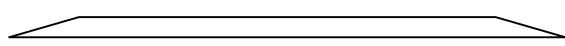
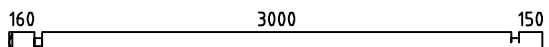
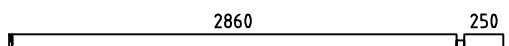
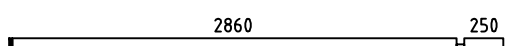
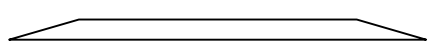
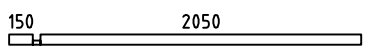
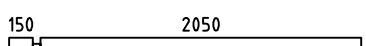
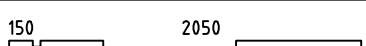
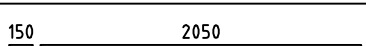
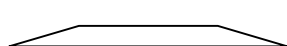
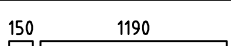
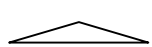
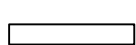
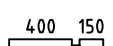
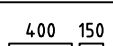

4x4+3 / 50 / 2013

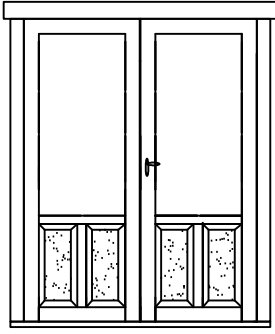
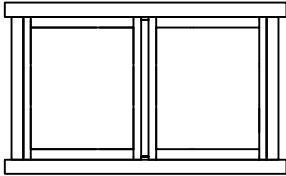
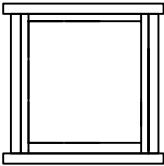
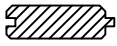
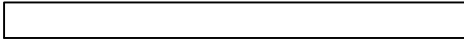
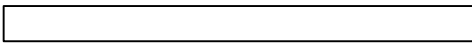
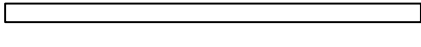
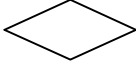

Pos	4x4+3 / 50 / 2013	ST	F (mm)	L (mm)
001		1	50x130	4510
002		1	50x130	4510
003		3	50x130	4400
004		35	50x130	4400
005	 Feder ab	1	50x130	4400
006		1	50x130	4400
007		1	50x65	4400
008		2	50x130	4060
009		3	50x130	3556
010		2	50x130	3410
011		1	50x130	3160
012		1	50x130	3160
013		3	50x130	2667
014		1	50x65	2250
015		7	50x130	2250
016		1	50x130	2250
017		1	50x130	2250
018		3	50x130	1778
019		14	50x130	1390
020		3	50x130	889
021		6	50x130	800
022		1	50x65	600
023		21	50x130	600

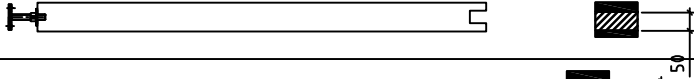
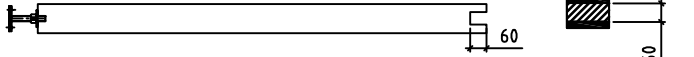
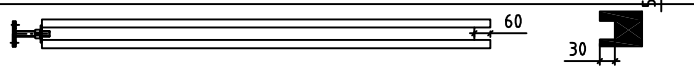

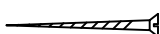

Pos	4x4+3 / 50 / 2013	ST	F (mm)	L (mm)				
U155S	Tür 1550x2015 Deur Door 	1						
	<table border="1" data-bbox="662 181 1035 271"> <tr> <td>Iso</td> <td>1200x544= 2st.</td> </tr> <tr> <td></td> <td>kotike 1 kmpl.</td> </tr> </table>	Iso	1200x544= 2st.		kotike 1 kmpl.			
Iso	1200x544= 2st.							
	kotike 1 kmpl.							
F1	Fenster 1620x910 Raam Window 	1						
	<table border="1" data-bbox="746 600 1120 651"> <tr> <td>Iso</td> <td>629x657 2st.</td> </tr> </table>	Iso	629x657 2st.					
Iso	629x657 2st.							
F2	Fenster 850x910 Raam Window 	1R						
	<table border="1" data-bbox="715 846 1088 898"> <tr> <td>Iso</td> <td>629x657 1st.</td> </tr> </table>	Iso	629x657 1st.					
Iso	629x657 1st.							
026	Dachbrettern Dakplanken Roofboard's 	172	90x20	2490				
027	Giebelleiste Gevelanderlijst Frontlist 	4	120x20	2650				
028	Giebelleiste Gevelanderlijst Frontlist 	4	90x20	2650				
029	Giebeldeckleiste Gevellijst Frontlist 	8	60x20	2650				
030	Giebelsegment Gevelsegment Frontsegment 	2						
031	Dachpappenleiste Dakshingleslijst Fillet of cardboard 	12	40x20	2550				
032	Pfosten Kolom 	2	90x90	1820				
033	Column 	1	90x90	1880				
034		2	90x90	1820				
035	Träger 	6	90x90	655				
036	Barriere 	2		2770				
037		1		1935				
038	Schrauben 	36	5,0x80					
039	Schrauben 	57	6,0x130					

# Doppeltür

Beschlag:

Türklinken mit der Lasche = 1 Kmp.

Schraube 5x80mm = 4 St.

Schnepper mit Schlüsseln = 1 Kmp.

Metalblechen (zwei St.) Pos. 5,  
befinden sich auf untere oder  
obere Türflügelkante.

Schrauben 5x80

Schrauben 5x80

