

Bemerkung: die Ansicht von Turen, Fenster und anderen Teilen kann abweichen von diesem Bild

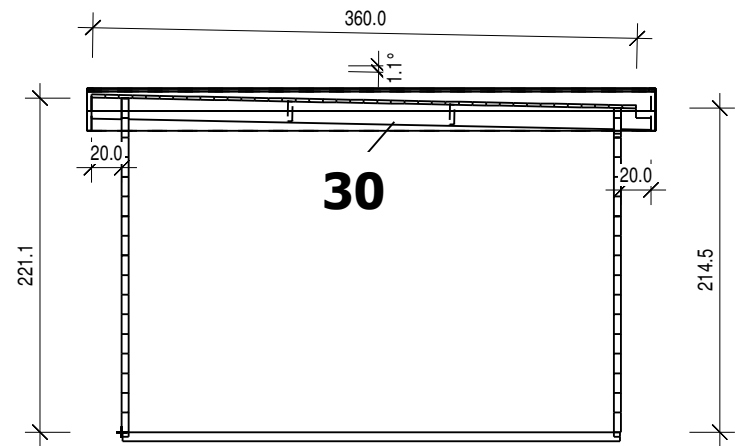

4,5

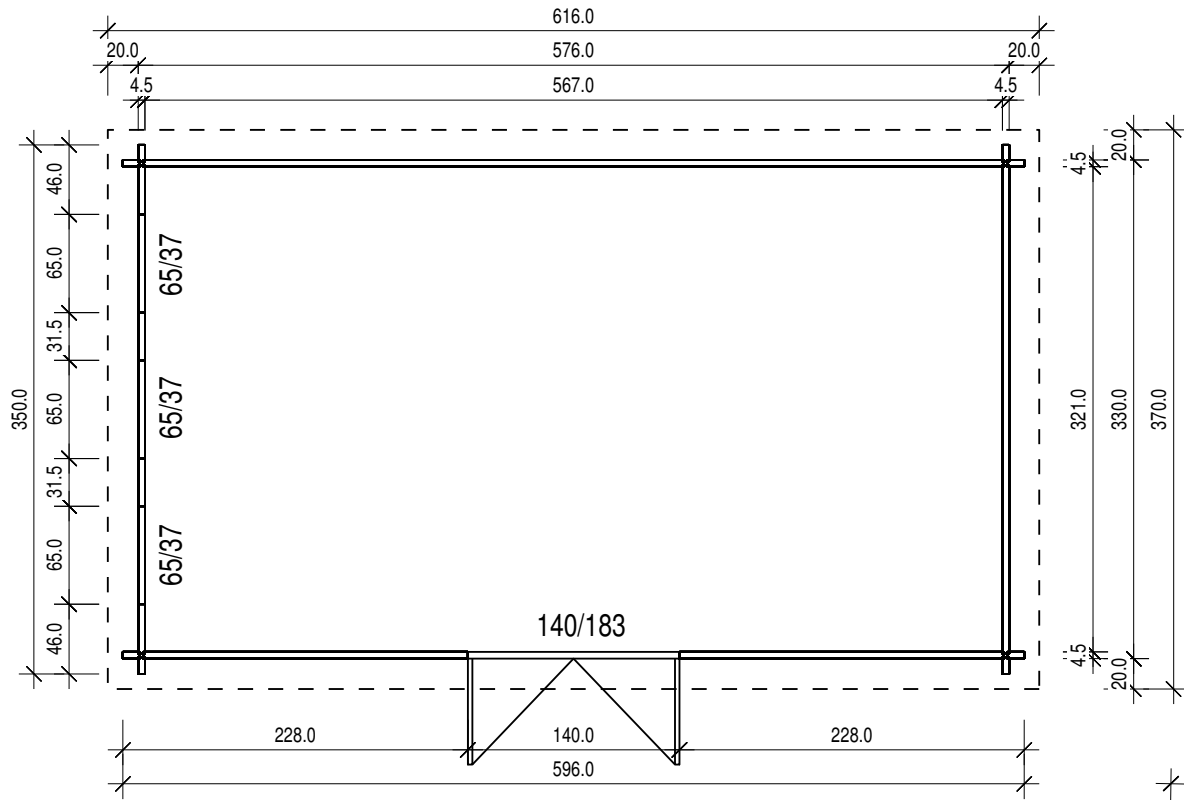

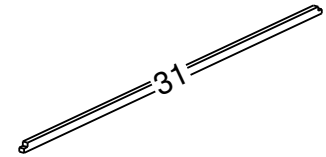
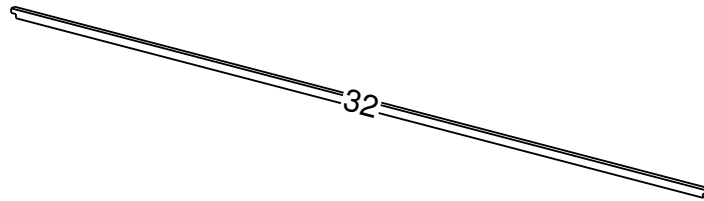
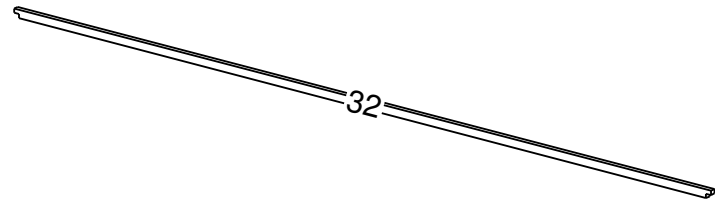
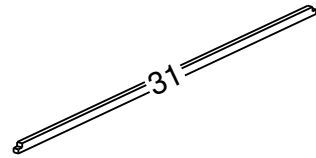
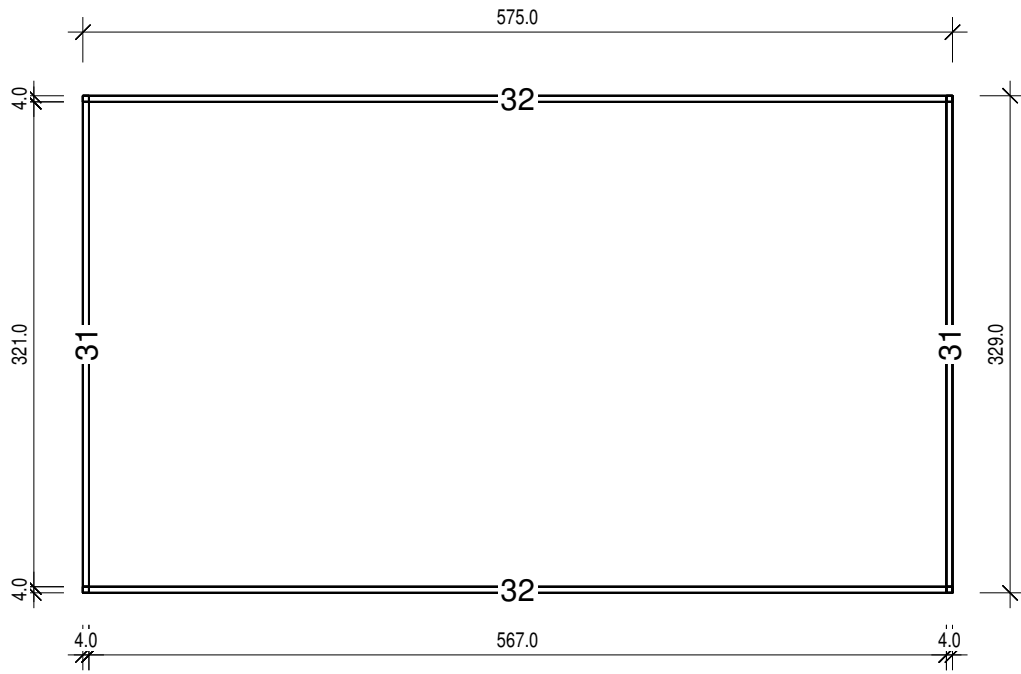

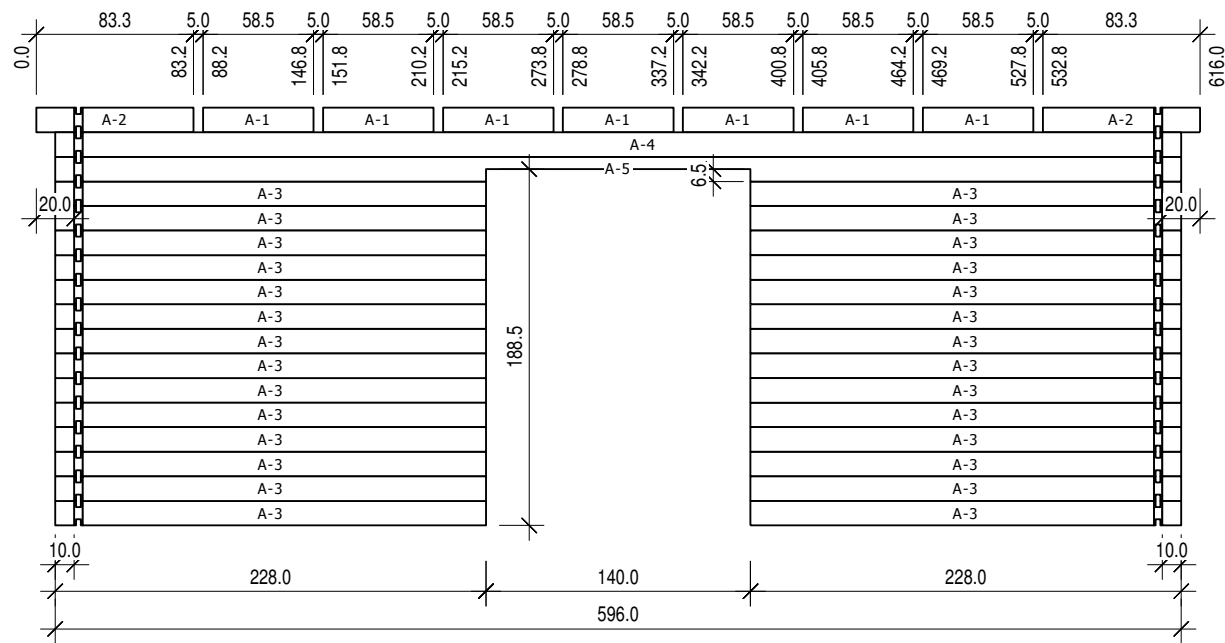

	Nr	H	L	Psc
A	1	13,0	58,5	7
A	2	13,0	83,3	2
A	3	13,0	228,0	28
A	4	13,0	596,0	1
A	5	13,0	596,0	1

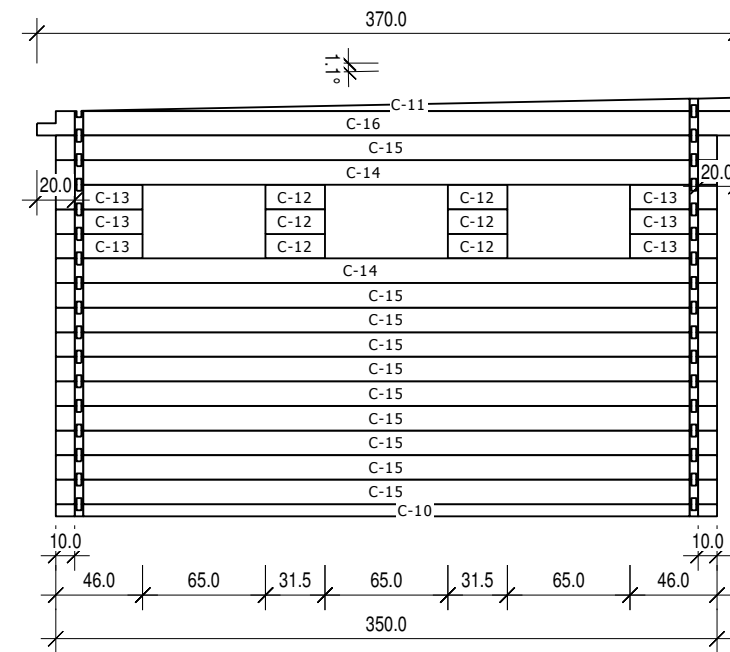

	Nr	H	L	Psc
C	12	13,0	31,5	6
C	13	13,0	46,0	6
C	11	7,0	346,5	1
C	14	13,0	350,0	2
C	15	13,0	350,0	10
C	10	6,5	350,0	1
C	16	13,0	370,0	1

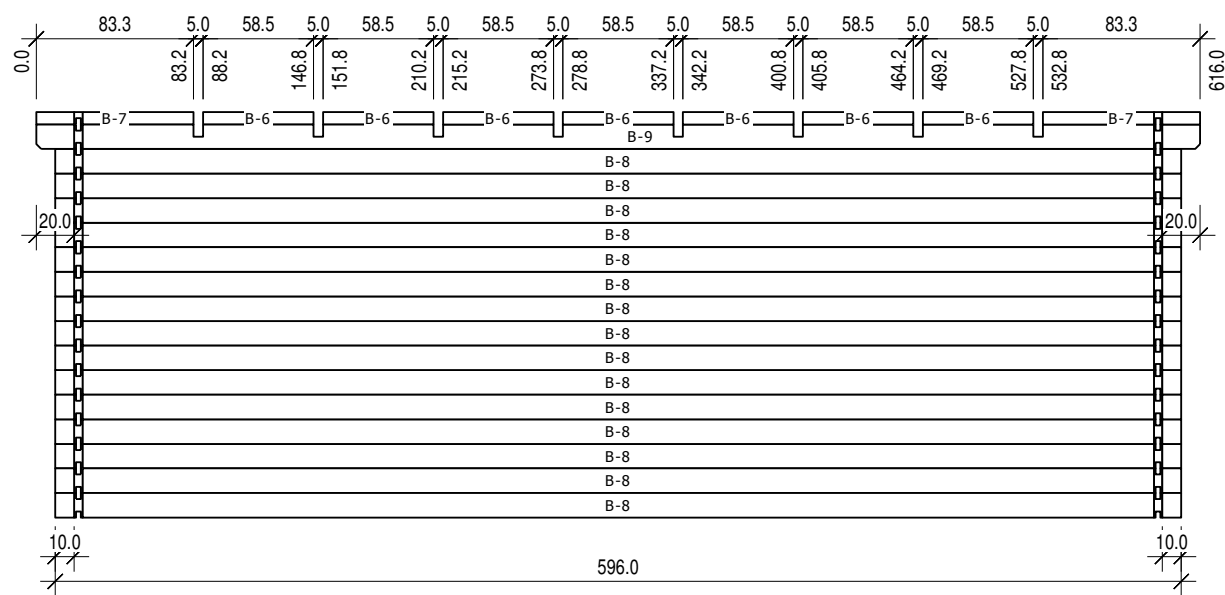

	Nr	H	L	Psc
B	6	6,5	58,5	7
B	7	6,5	83,3	2
B	8	13,0	596,0	15
B	9	13,0	616,0	1

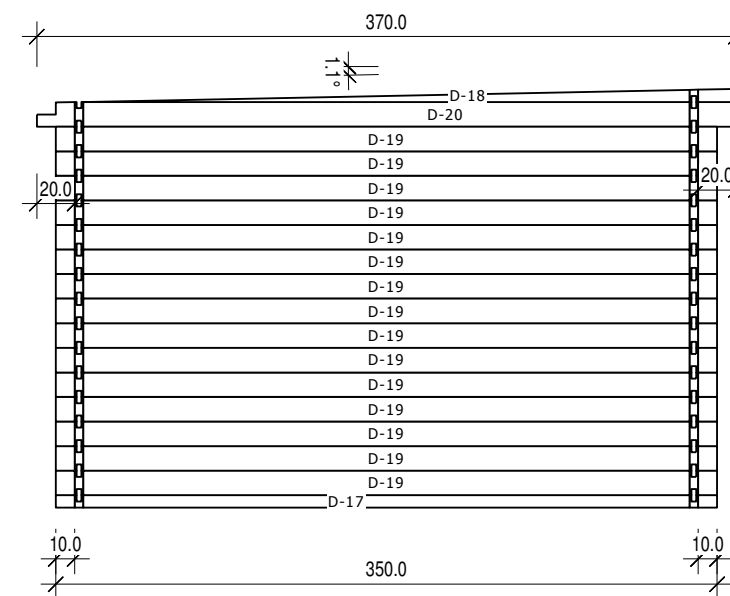

	Nr	H	L	Psc
D	18	7,0	346,5	1
D	19	13,0	350,0	15
D	17	6,5	350,0	1
D	20	13,0	370,0	1