

Bemerkung: die Ansicht von Turen, Fenster und anderen Teilen kann abweichen von diesem Bild

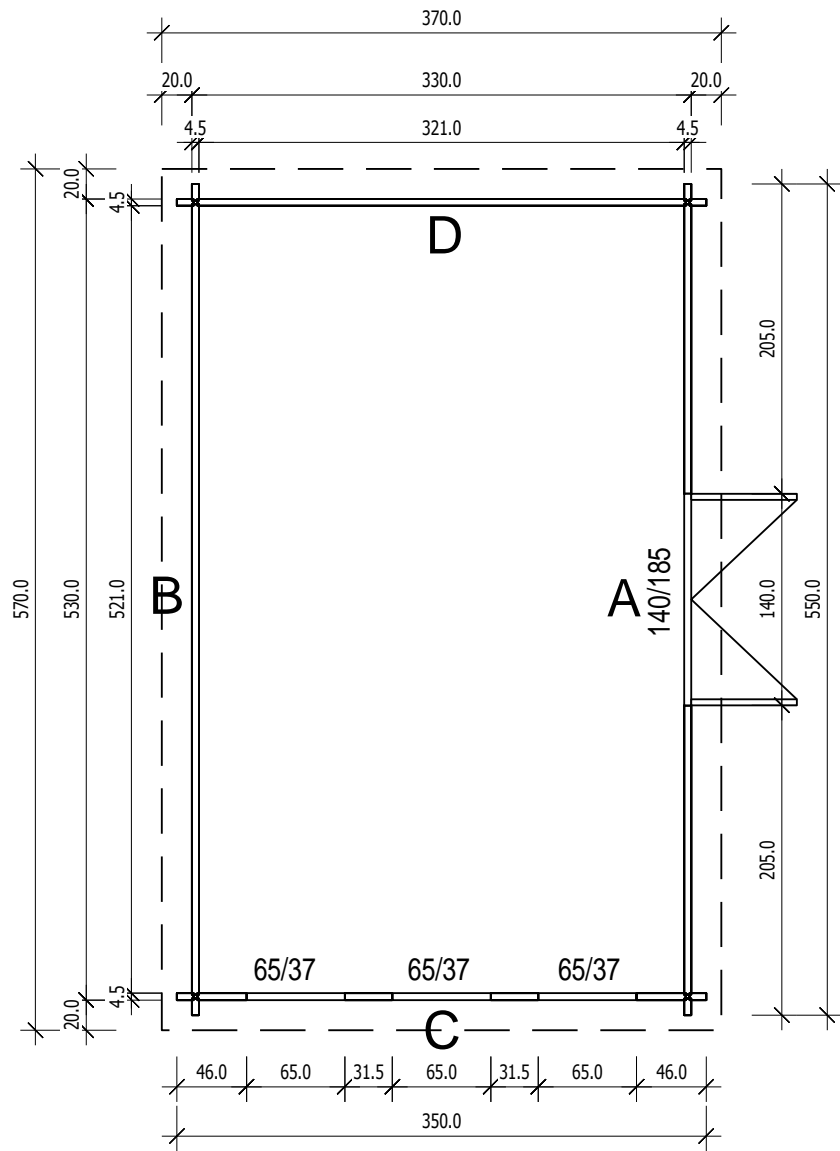

Grundriss



4,5

Schnitt

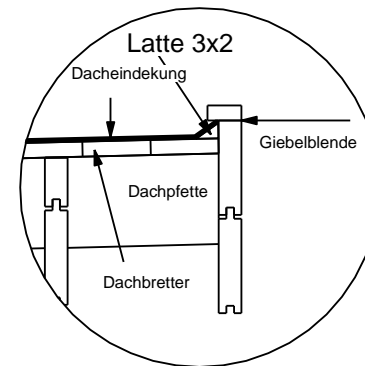
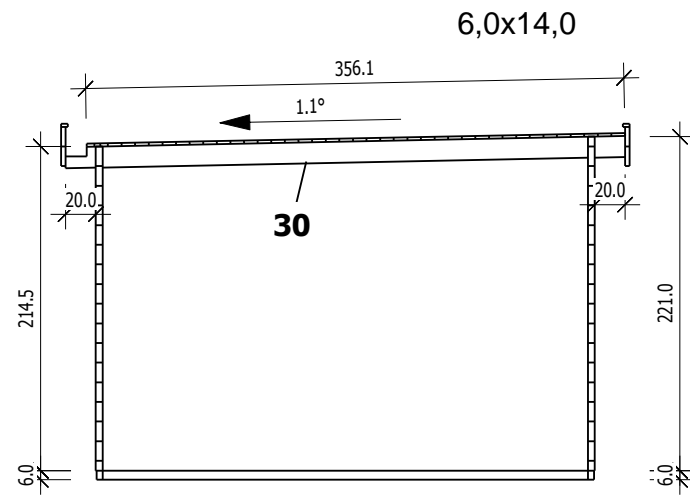

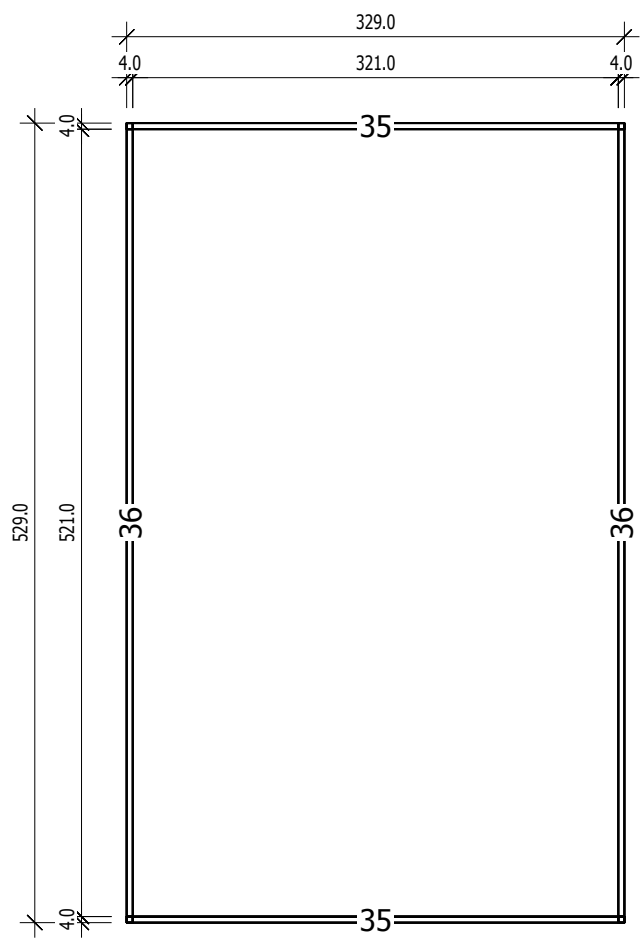

Grundrahmenplan

| Nr. | B | H | L | Psc |
|-----|------|------|-------|-----|
| | [cm] | [cm] | [cm] | |
| 35 | 4.0 | 6.0 | 329.0 | 2 |
| 36 | 4.0 | 6.0 | 529.0 | 2 |

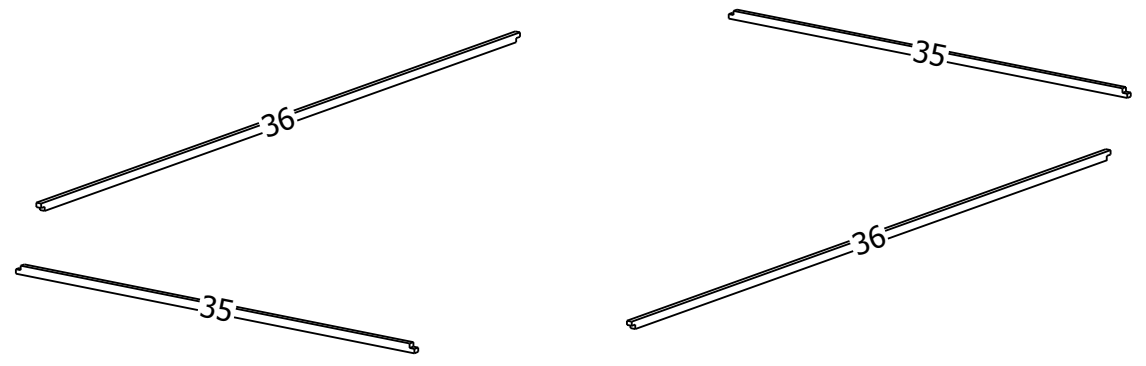

A

M 1:40

6,0x14,0

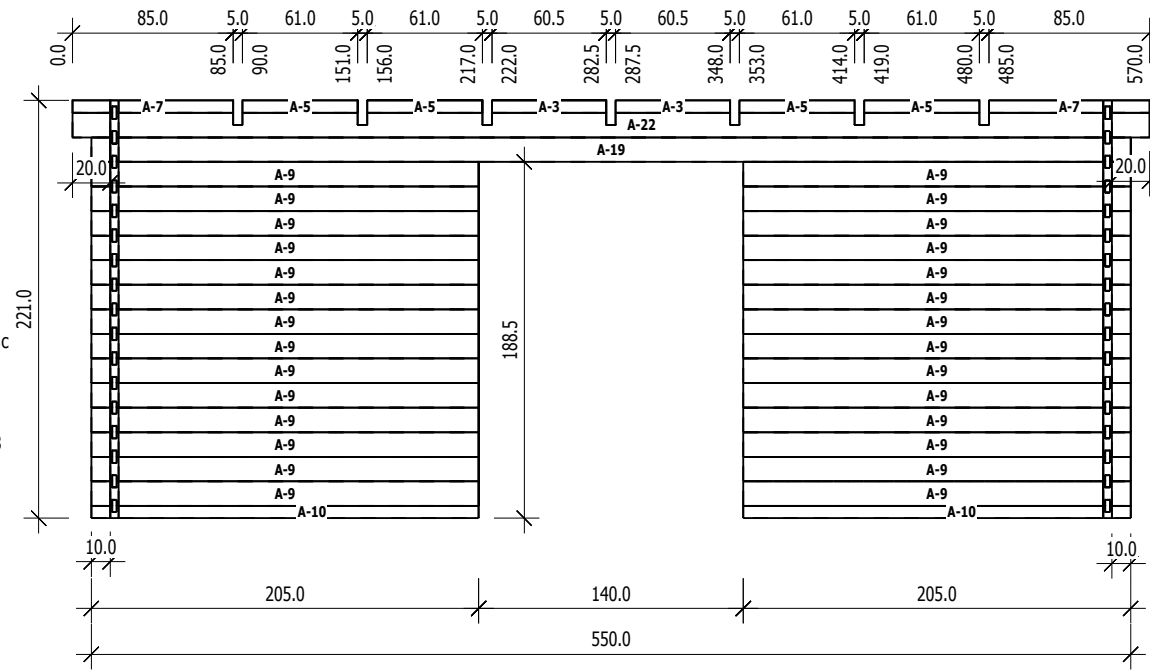

| | Nr | H | L | Psc |
|---|----|------|-------|-----|
| A | 3 | 6.5 | 60.5 | 2 |
| A | 5 | 6.5 | 61.0 | 4 |
| A | 7 | 6.5 | 85.0 | 2 |
| A | 9 | 13.0 | 205.0 | 28 |
| A | 10 | 6.5 | 205.0 | 2 |
| A | 19 | 13.0 | 550.0 | 1 |
| A | 22 | 13.0 | 570.0 | 1 |

C

M 1:40

4,5

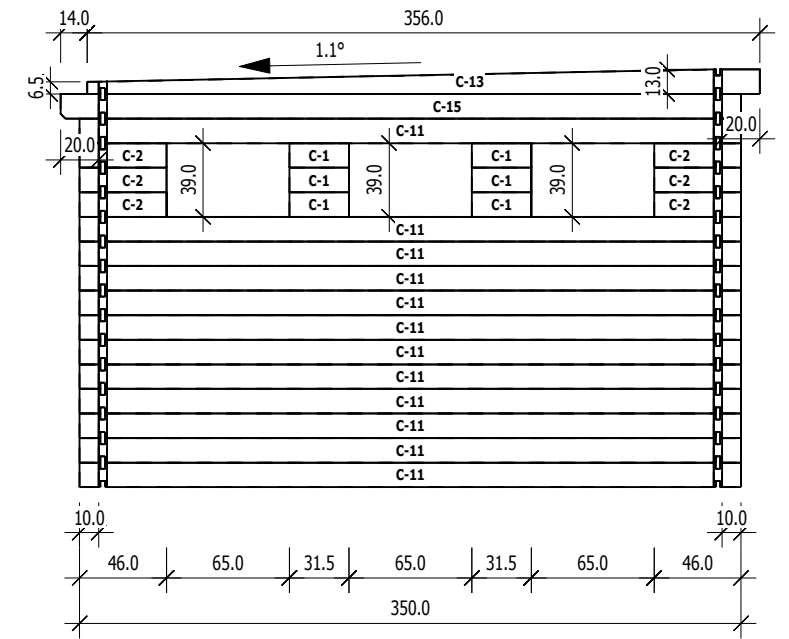

| | Nr | H | L | Psc |
|---|----|------|-------|-----|
| C | 1 | 13.0 | 31.5 | 6 |
| C | 2 | 13.0 | 46.0 | 6 |
| C | 11 | 13.0 | 350.0 | 12 |
| C | 13 | 13.0 | 356.0 | 1 |
| C | 15 | 13.0 | 360.0 | 1 |

B

M 1:40

6,0x14,0

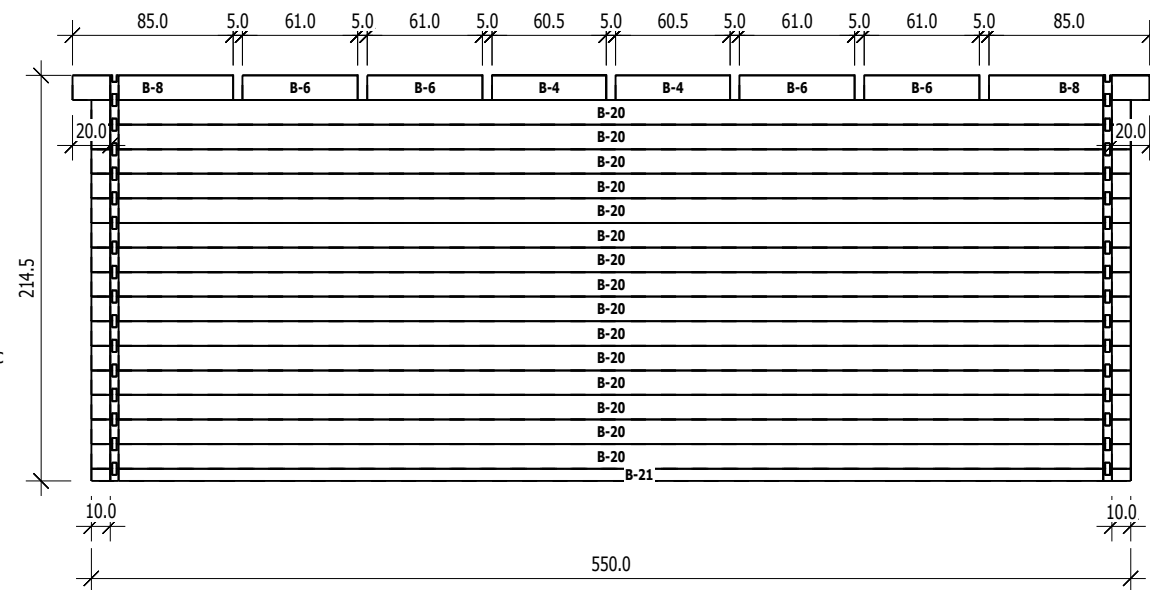

| | Nr | H | L | Psc |
|---|----|------|-------|-----|
| B | 4 | 13.0 | 60.5 | 2 |
| B | 6 | 13.0 | 61.0 | 4 |
| B | 8 | 13.0 | 85.0 | 2 |
| B | 20 | 13.0 | 550.0 | 15 |
| B | 21 | 6.5 | 550.0 | 1 |

D

M 1:40

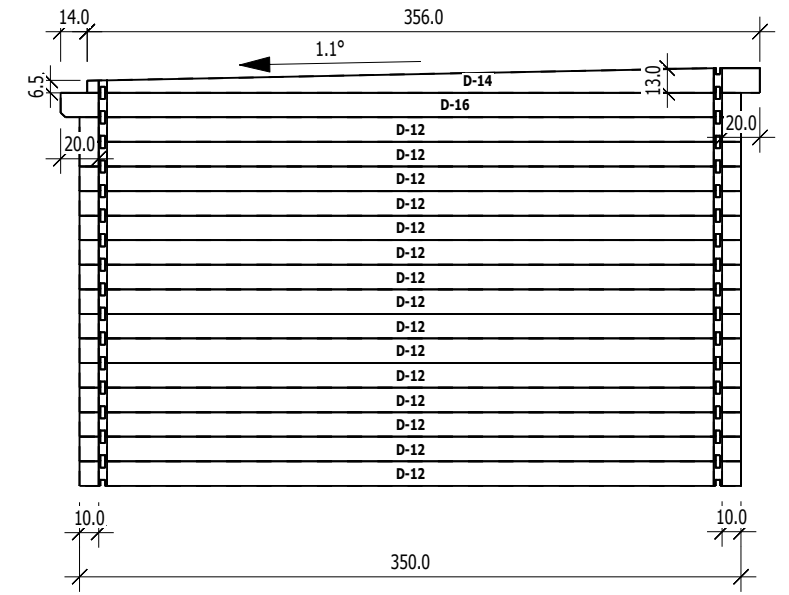

| | Nr | H | L | Psc |
|---|----|------|-------|-----|
| D | 12 | 13.0 | 350.0 | 15 |
| D | 14 | 13.0 | 356.0 | 1 |
| D | 16 | 13.0 | 360.0 | 1 |