

3,0

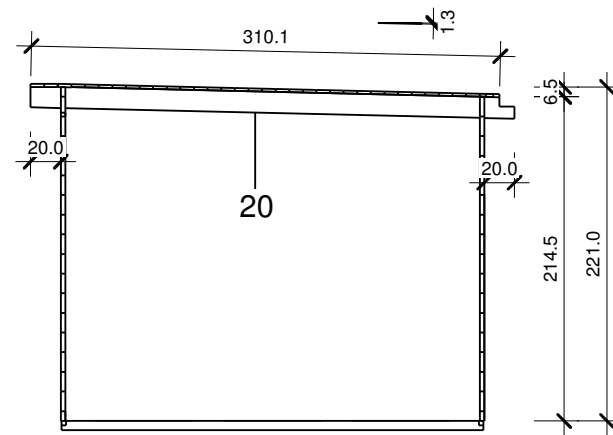

		1 : 50

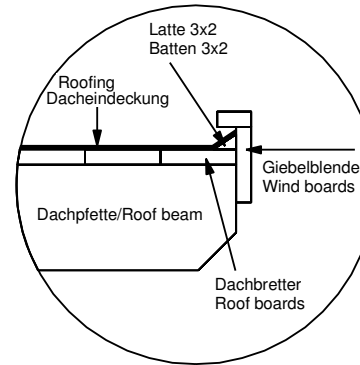
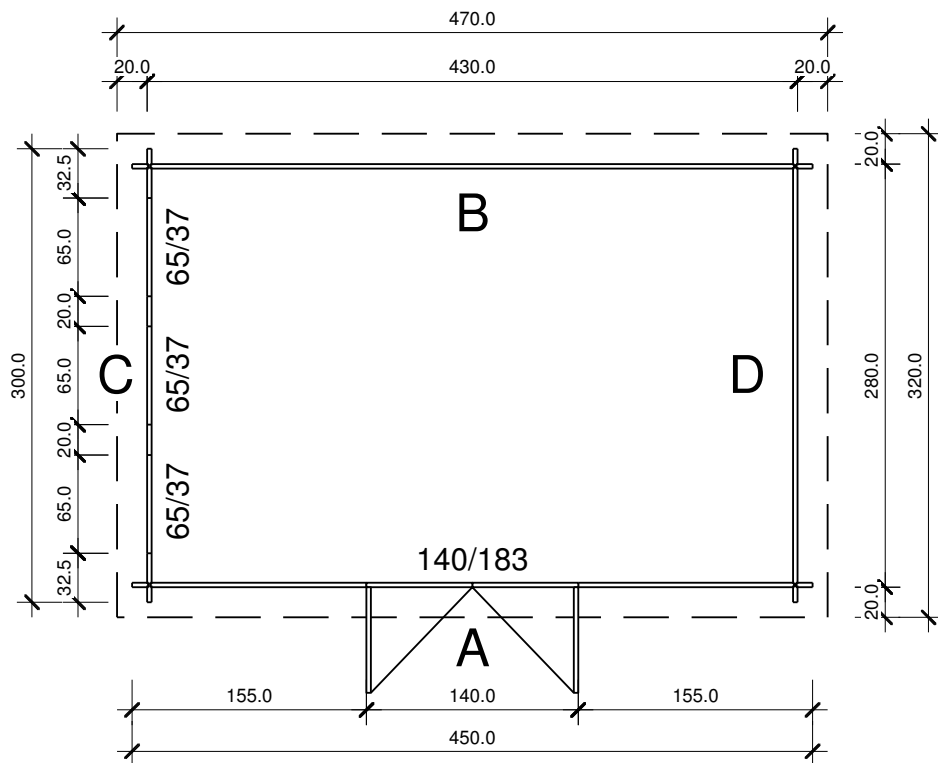
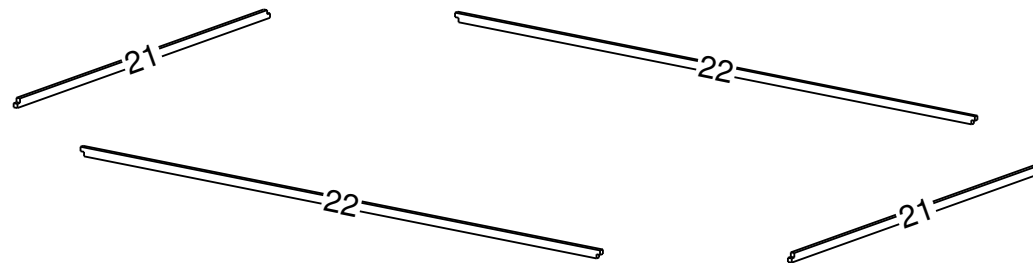
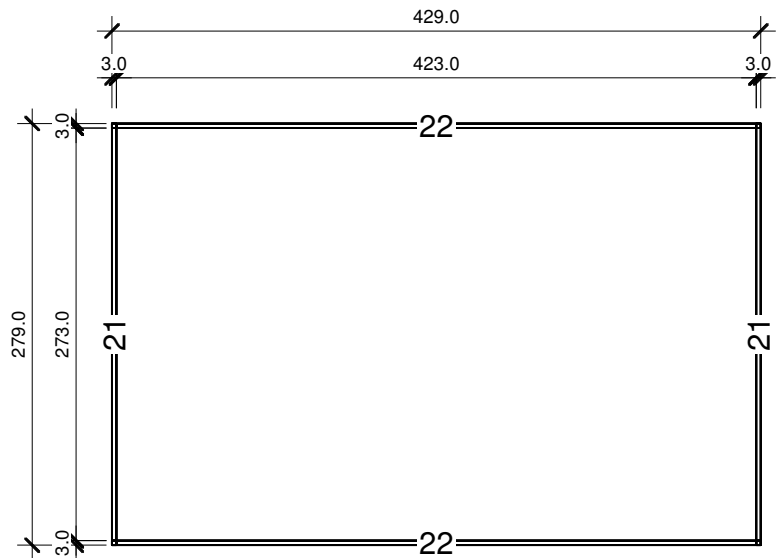

Nr.21 Pagrindas 3 x 6 x 279cm - 2vnt.
Nr.22 Pagrindas 3 x 6 x 429cm - 2vnt.

		1 : 50

A
M 1:40

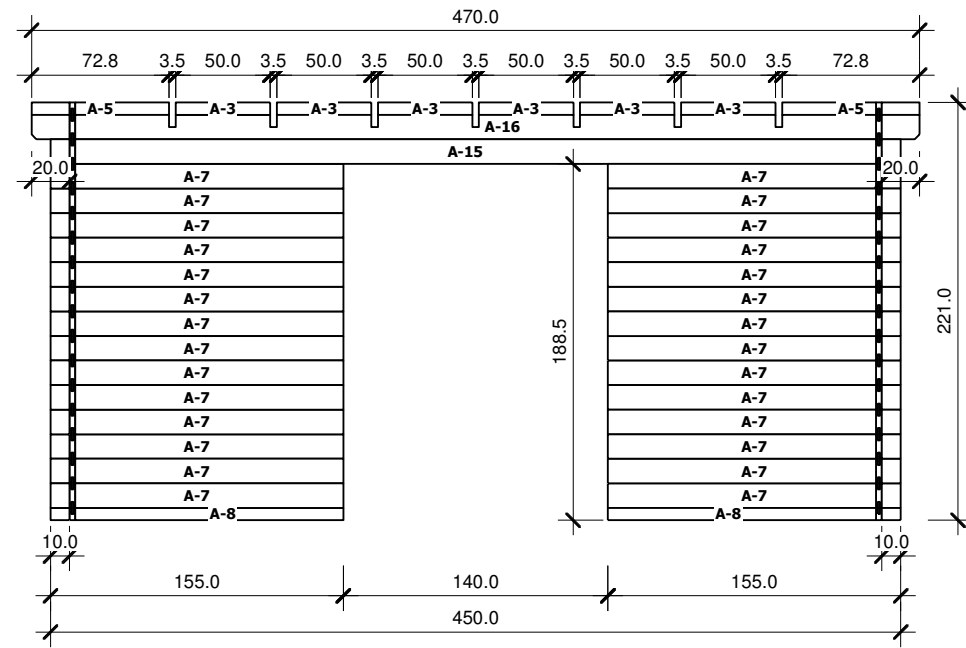

Nr	H	L	Psc
A 3	6,5	50,0	6
A 5	6,5	72,8	2
A 7	13,0	155,0	28
A 8	6,5	155,0	2
A 15	13,0	450,0	1
A 16	13,0	470,0	1

C
M 1:40

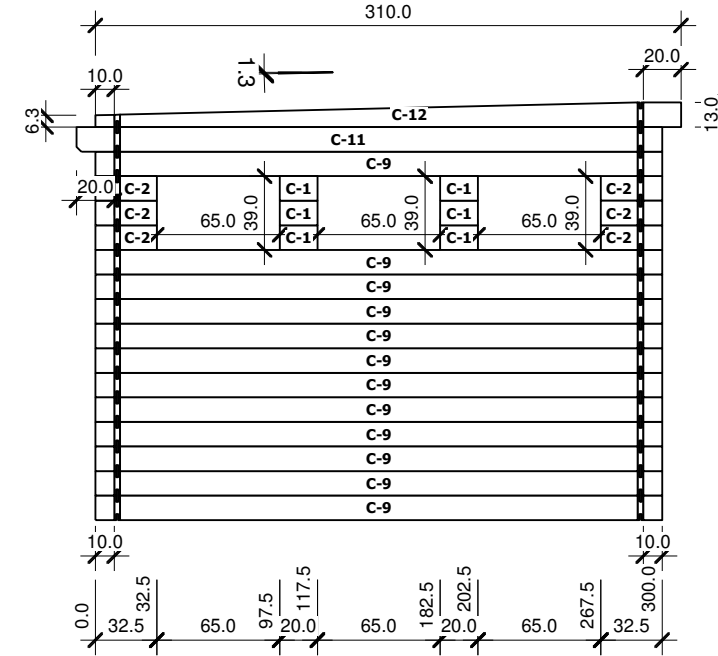

Nr	H	L	Psc
C 1	13,0	20,0	6
C 2	13,0	32,5	6
C 9	13,0	300,0	12
C 11	13,0	310,0	1
C 12	13,0	310,0	1

B
M 1:40

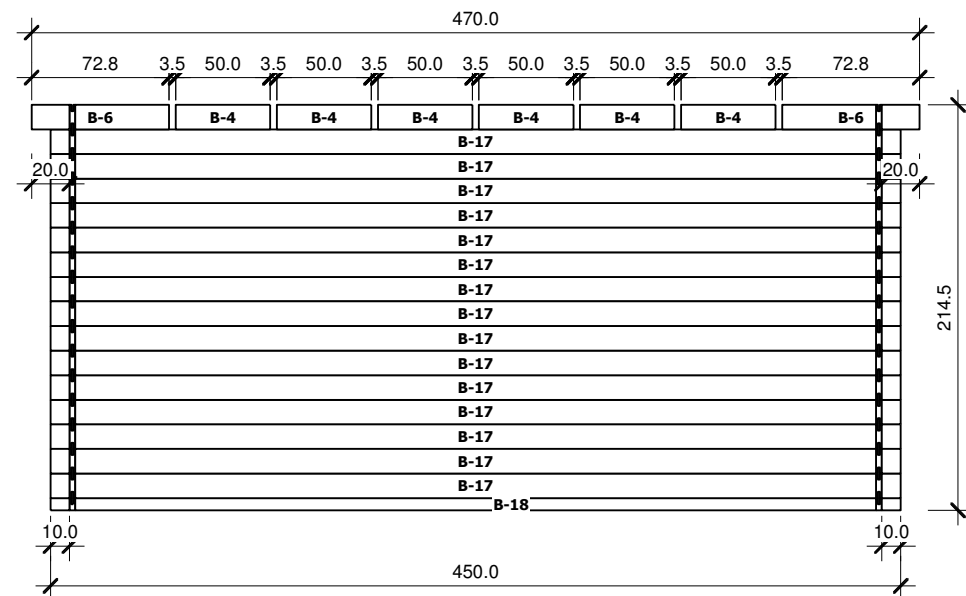

Nr	H	L	Psc
B 4	13,0	50,0	6
B 6	13,0	72,8	2
B 17	13,0	450,0	15
B 18	6,5	450,0	1

D
M 1:40

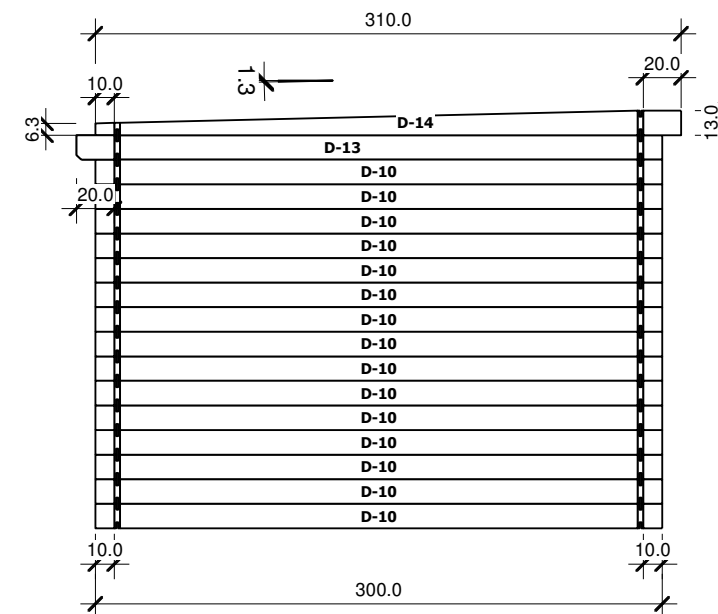

Nr	H	L	Psc
D 10	13,0	300,0	15
D 13	13,0	310,0	1
D 14	13,0	310,0	1

Atliko:	R.Zirgulis	Data:	22.03.2010	Projekto. Nr.:	NL-0087	Namelio modelis:	MT-4530
				Grupe(siena):	A B C D	4,3x2,8x30mm	
				Sienos storis:	3.0cm		

MT-4530

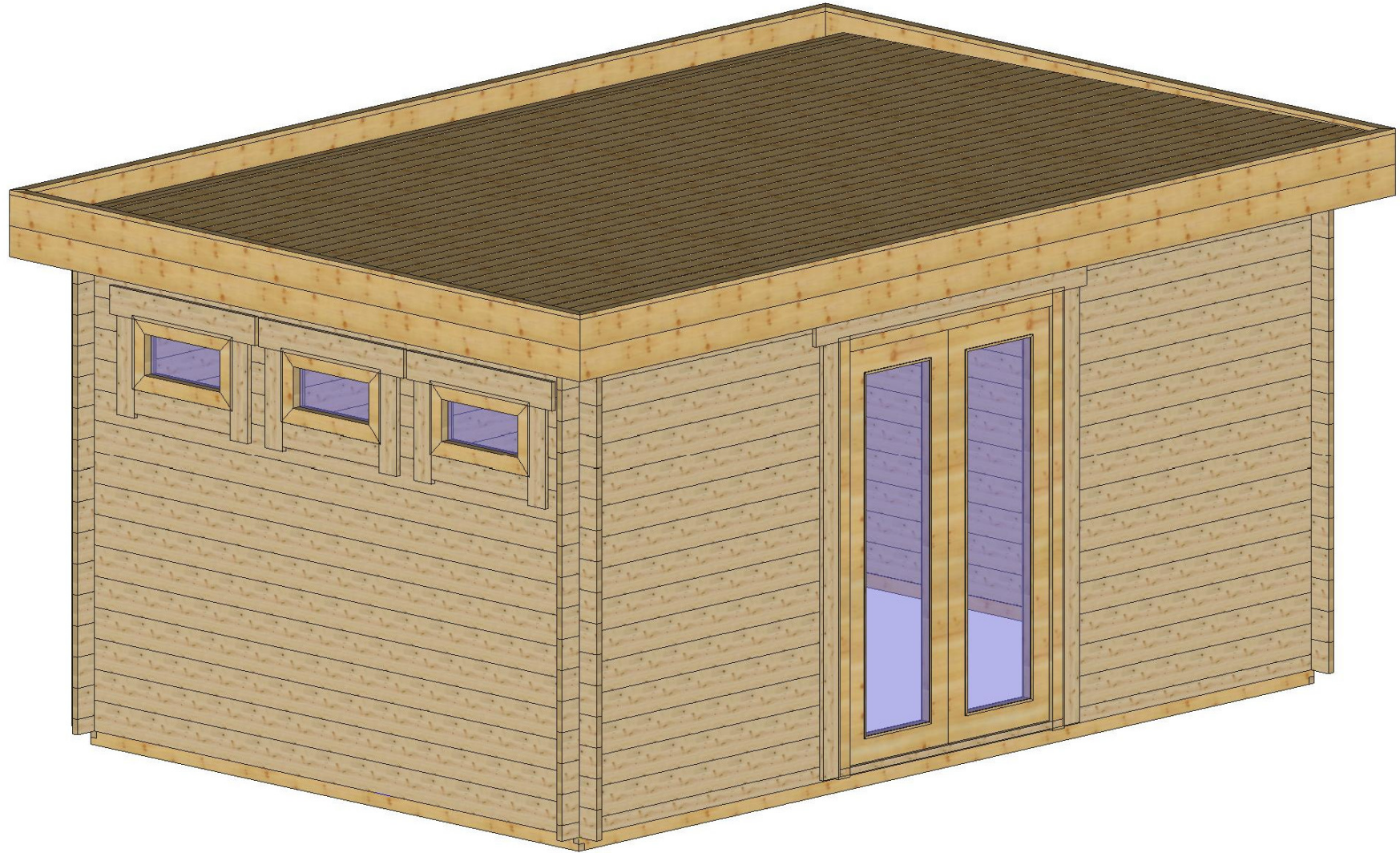

Bemerkung: die ansicht von turen, fenster und andere teile kann abweichen von diesem bild