

# Schnitt

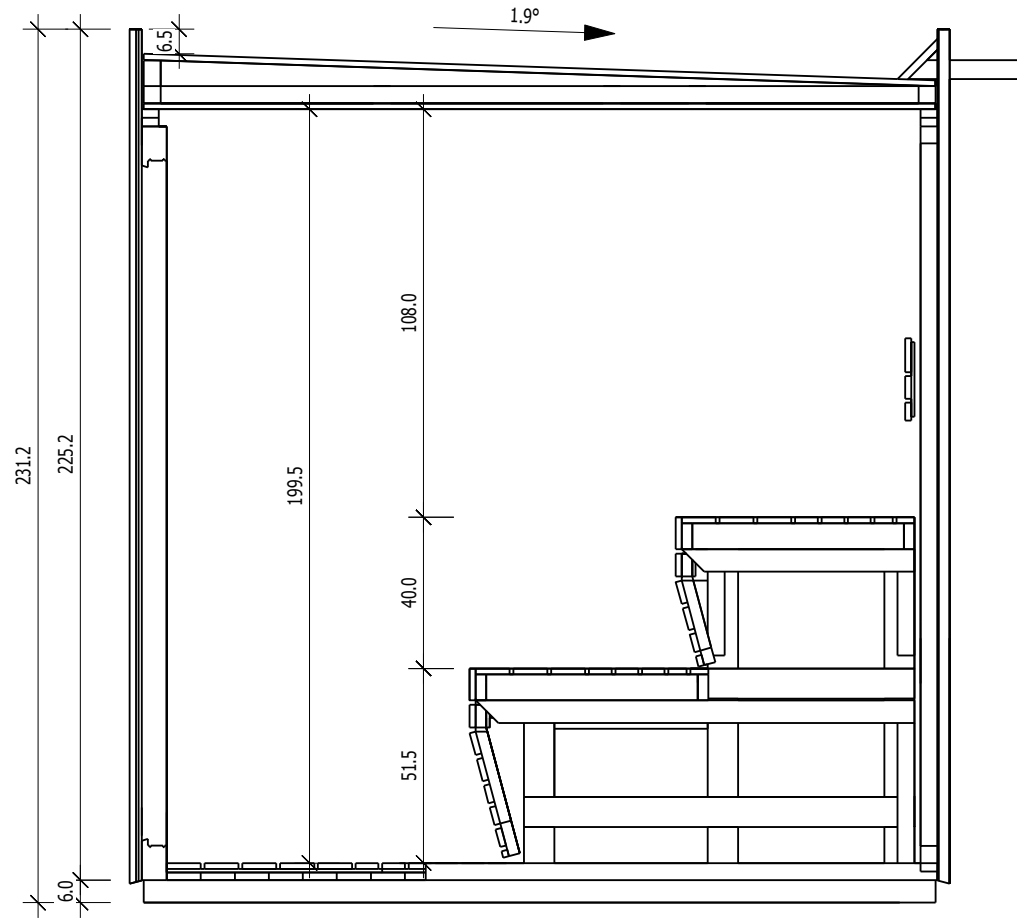

# Grundriss

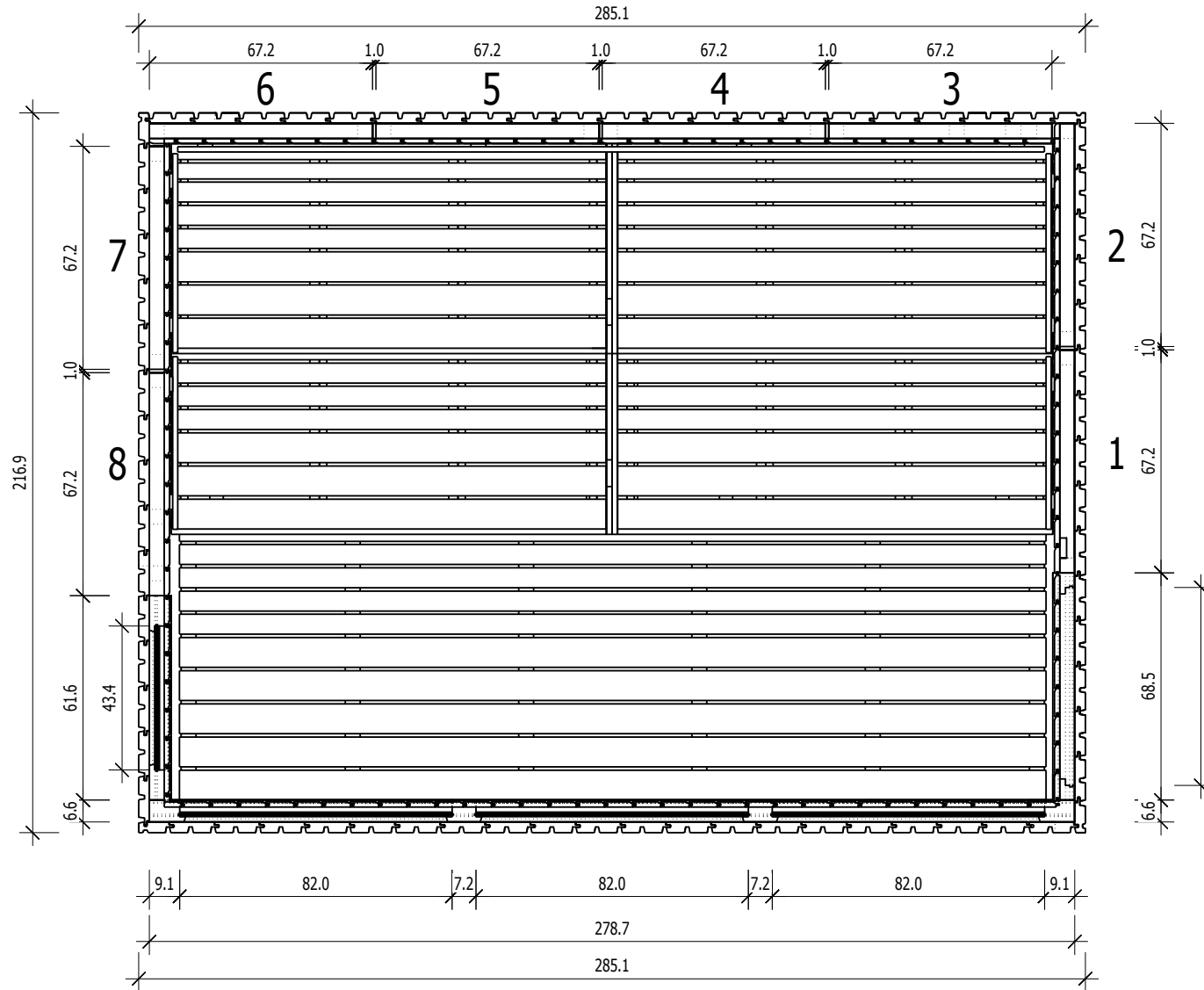

# Grundrahmenplan

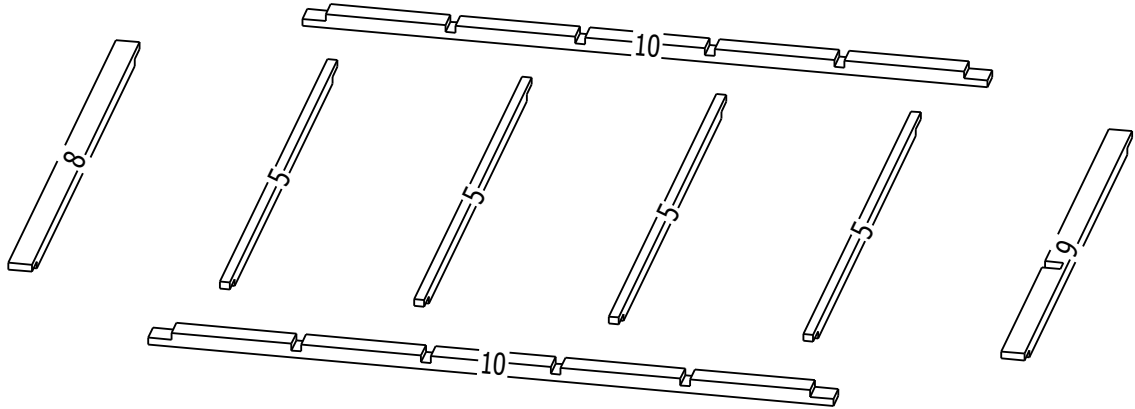
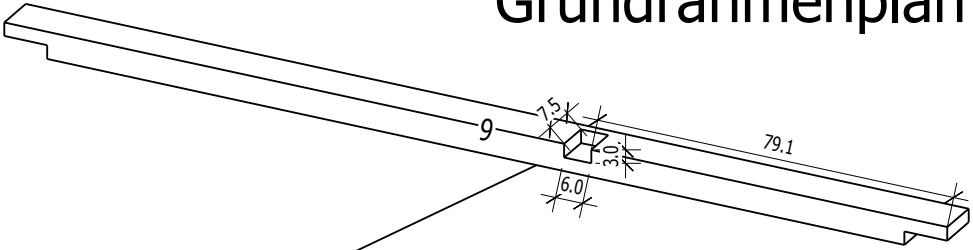
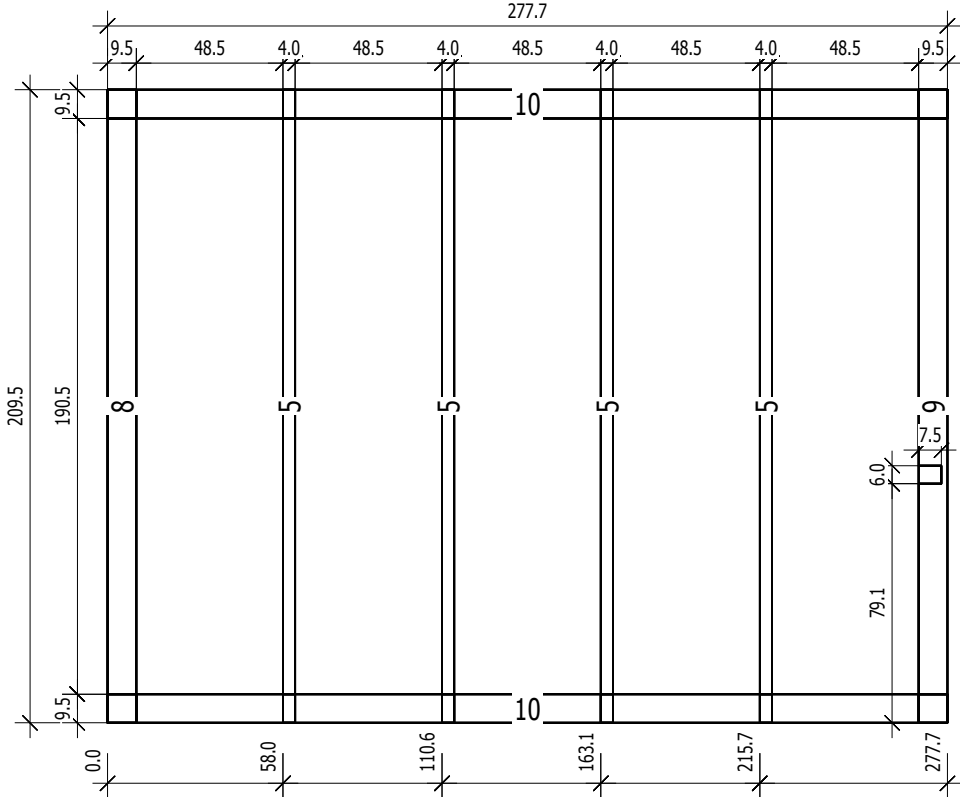

# Unterrahm

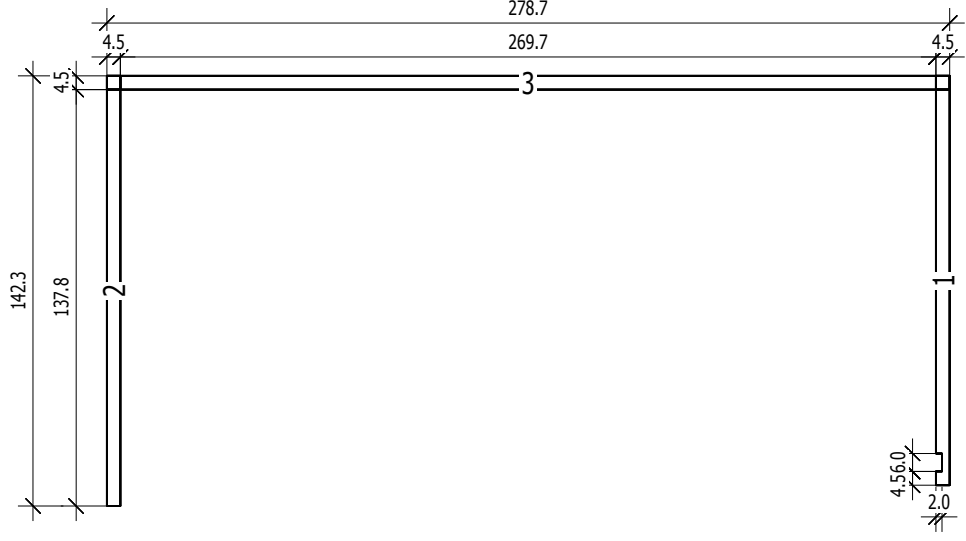

# Oberrahm

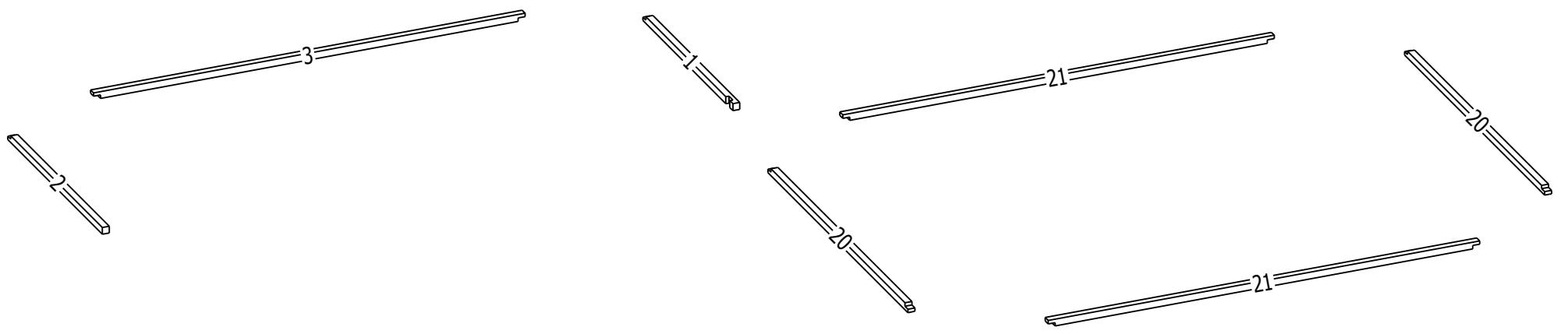
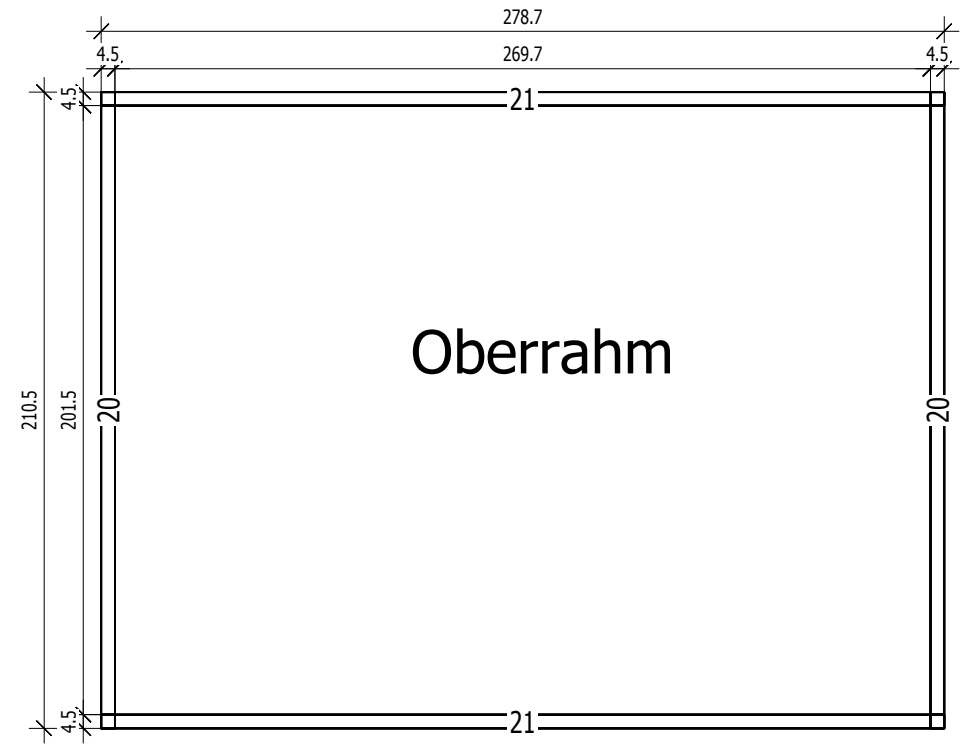

# Dachelemente

