

6732 / 40 / 22

6732 / 40 / 22

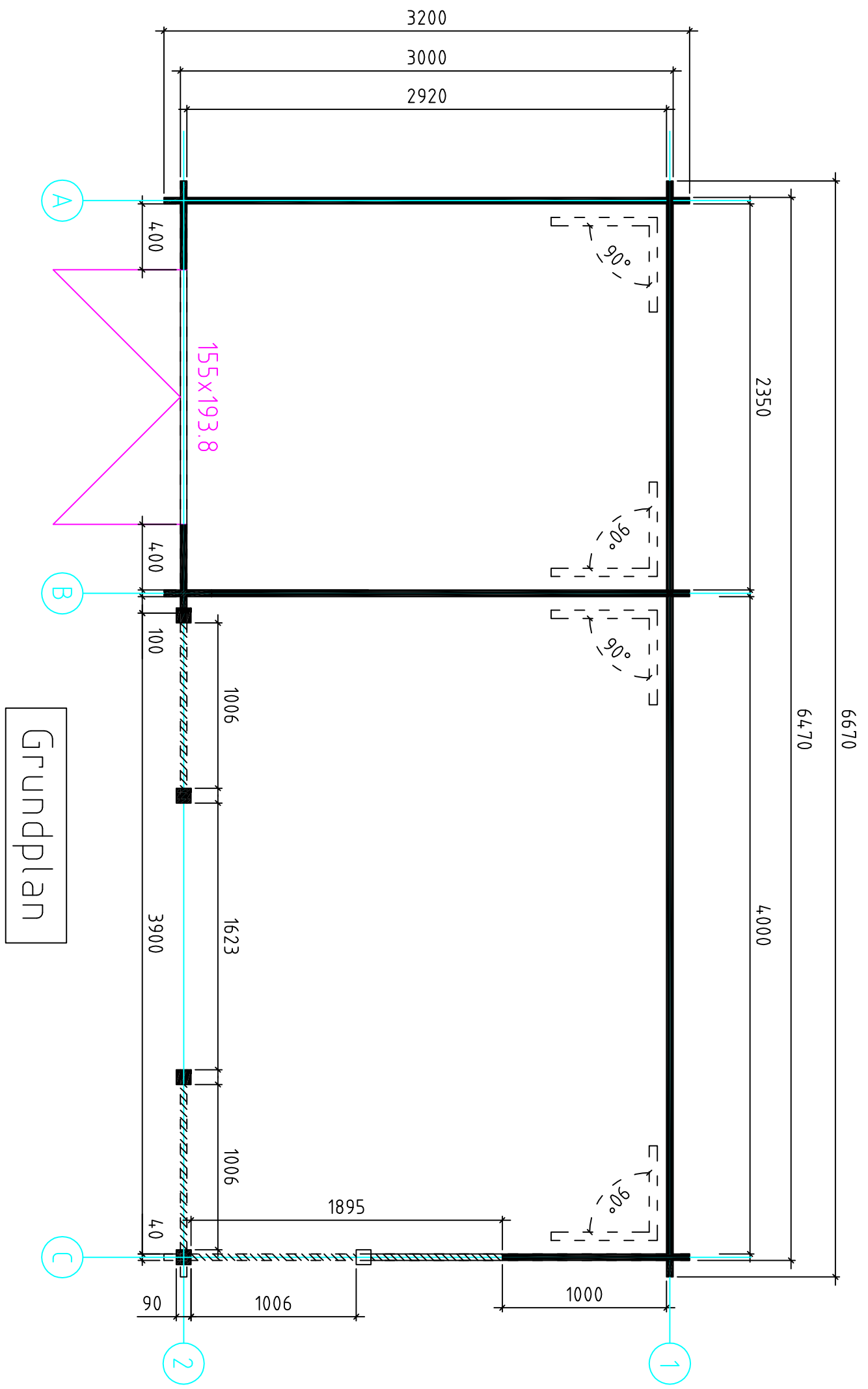

Wand 1 →

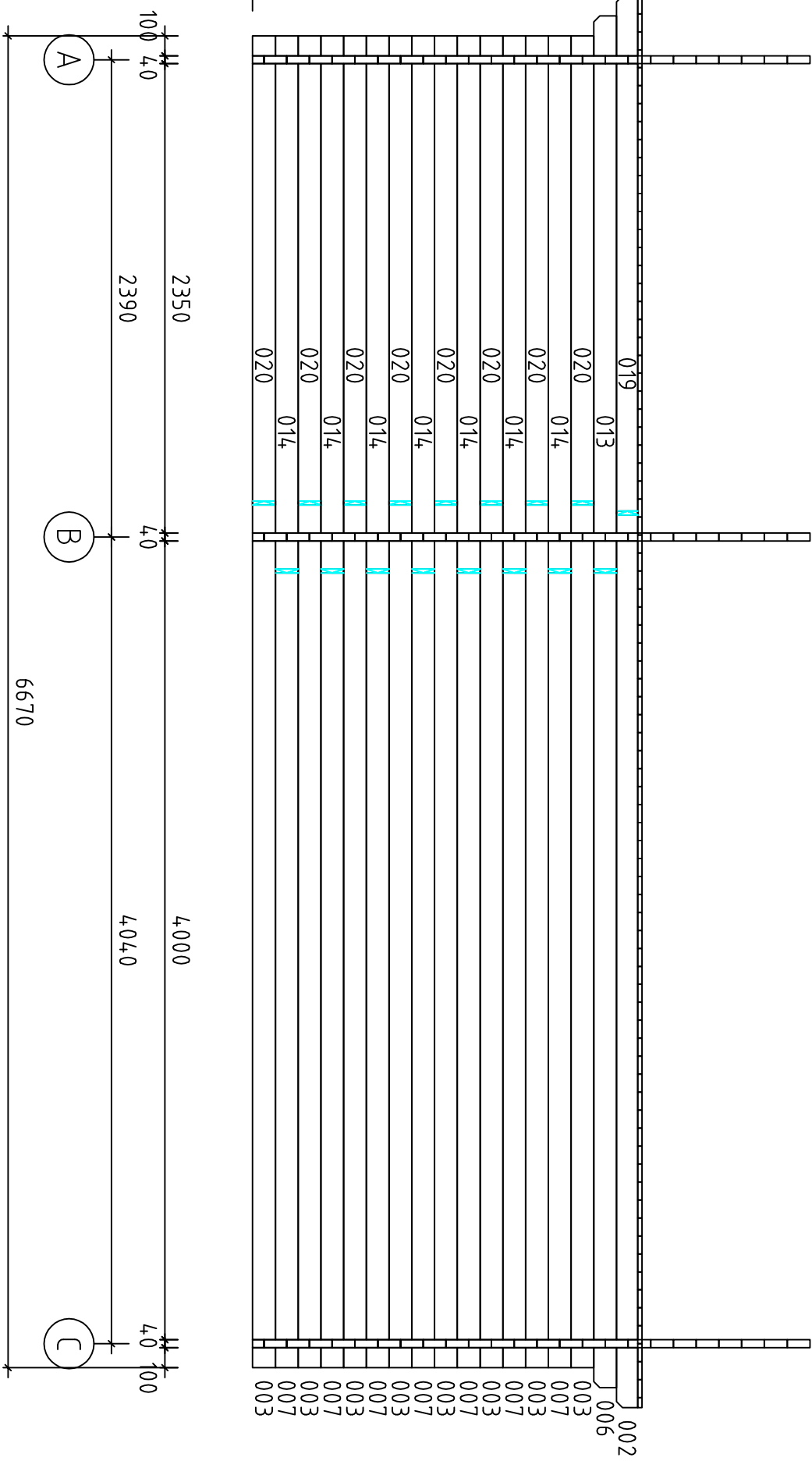

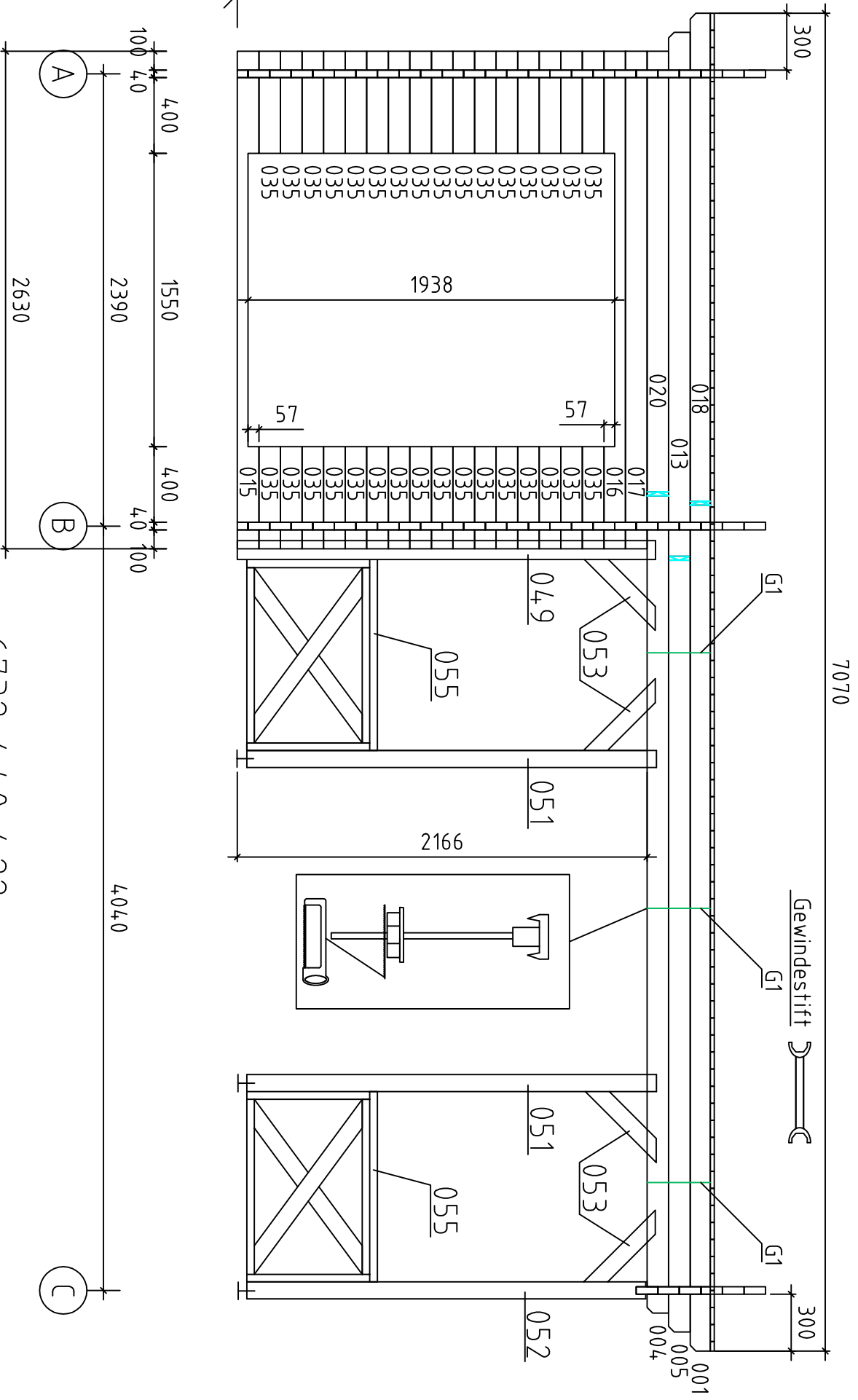

6732 / 40 / 22

Wand 2 ↗

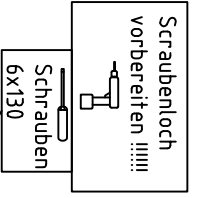

6732 / 40 / 22



Wand A 

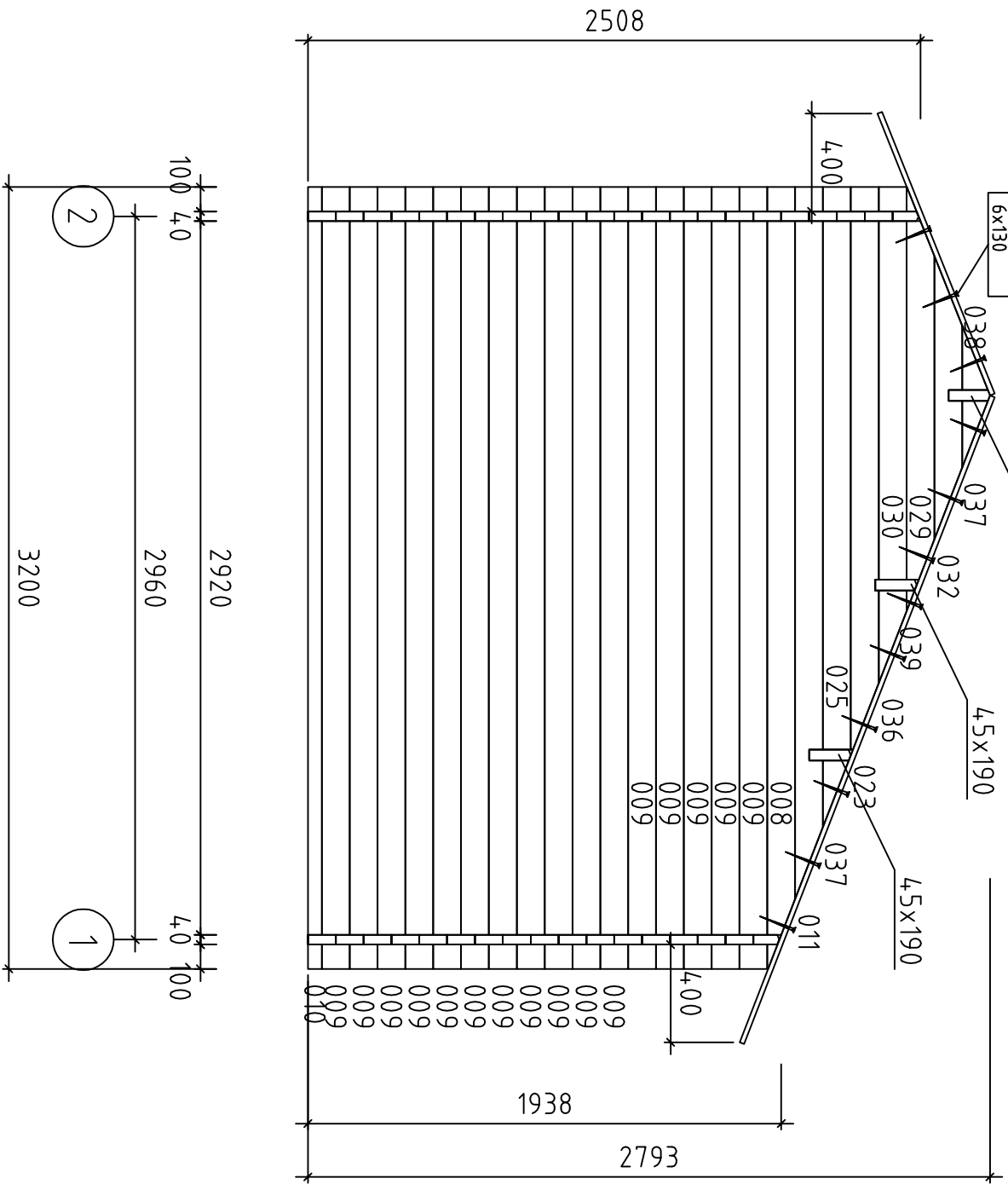

6732 / 40 / 22

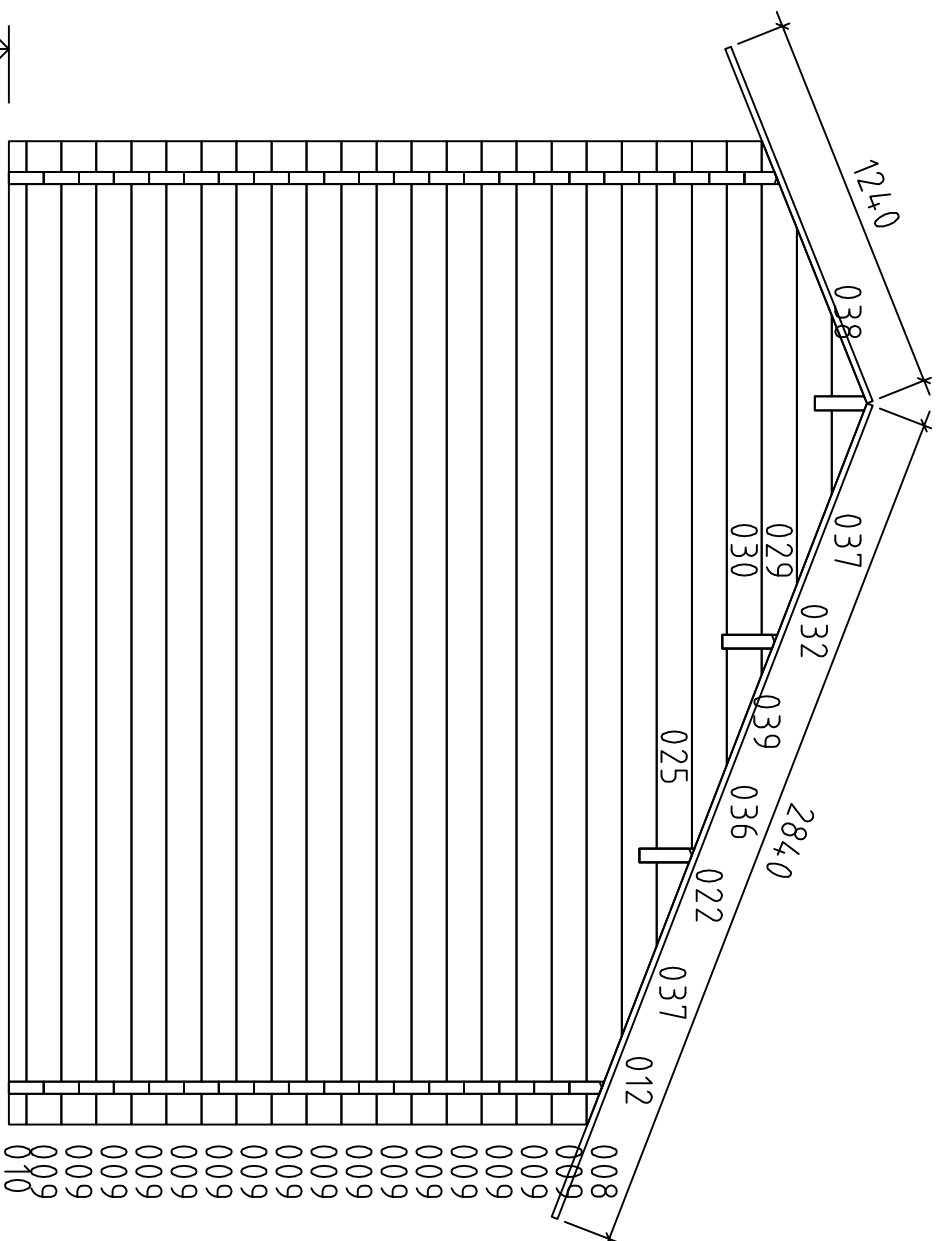

Wand B

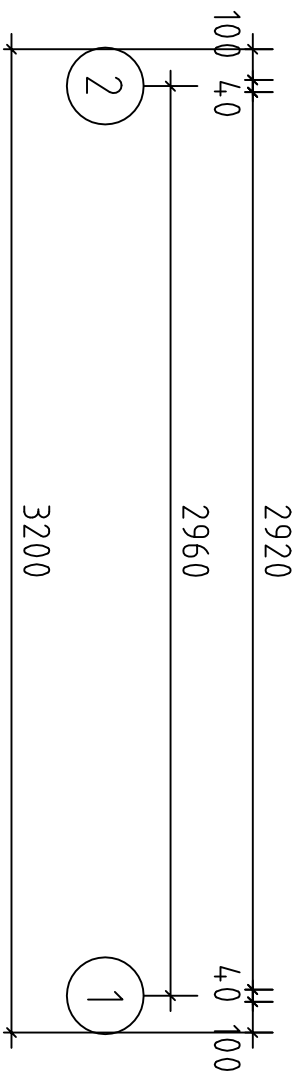

6732 / 40 / 22

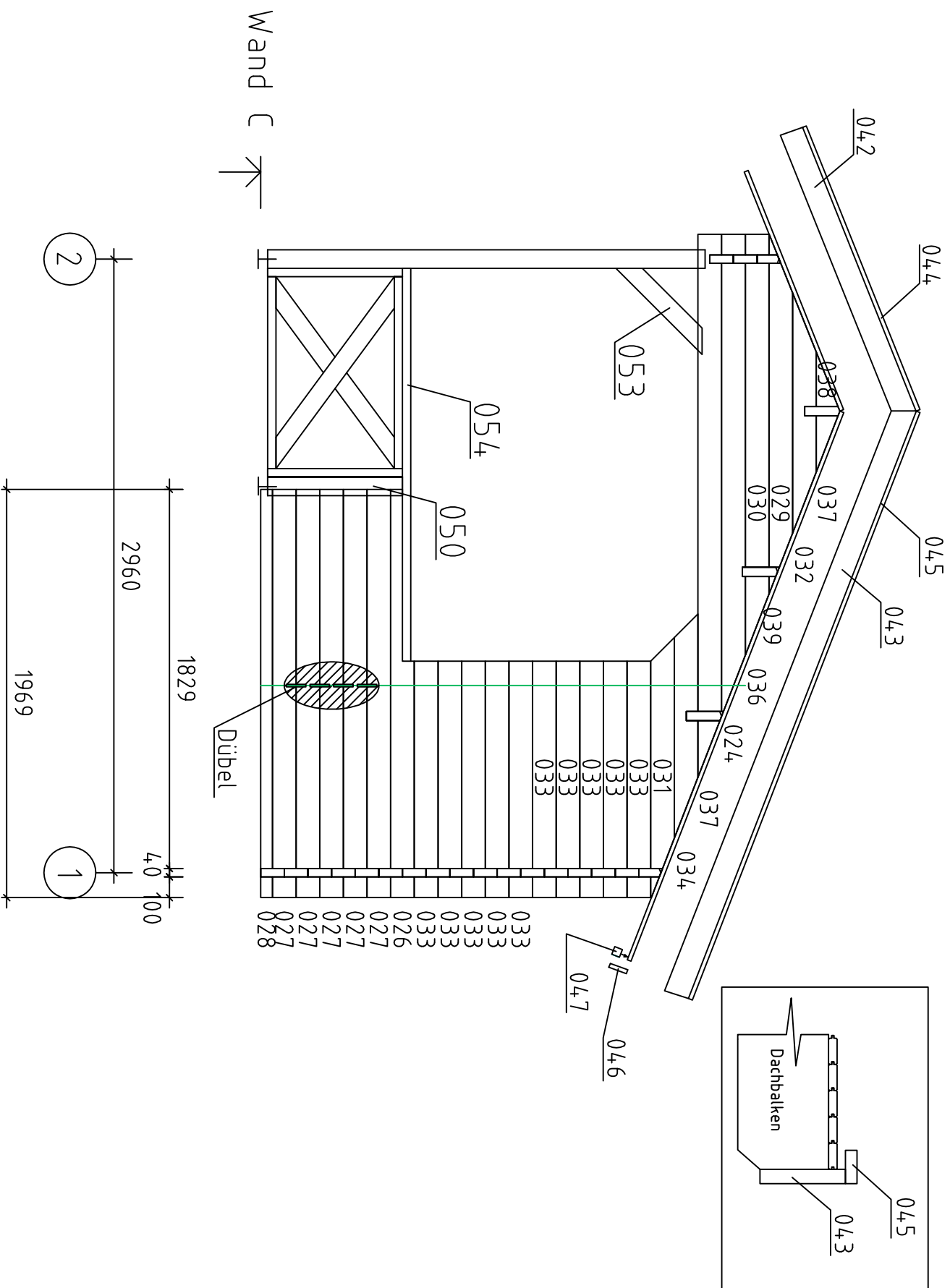

6732 / 40 / 22

Den Einbau den Tür
sollten Sie nach der
5-6 Bohlenschicht
vornehmen!!!

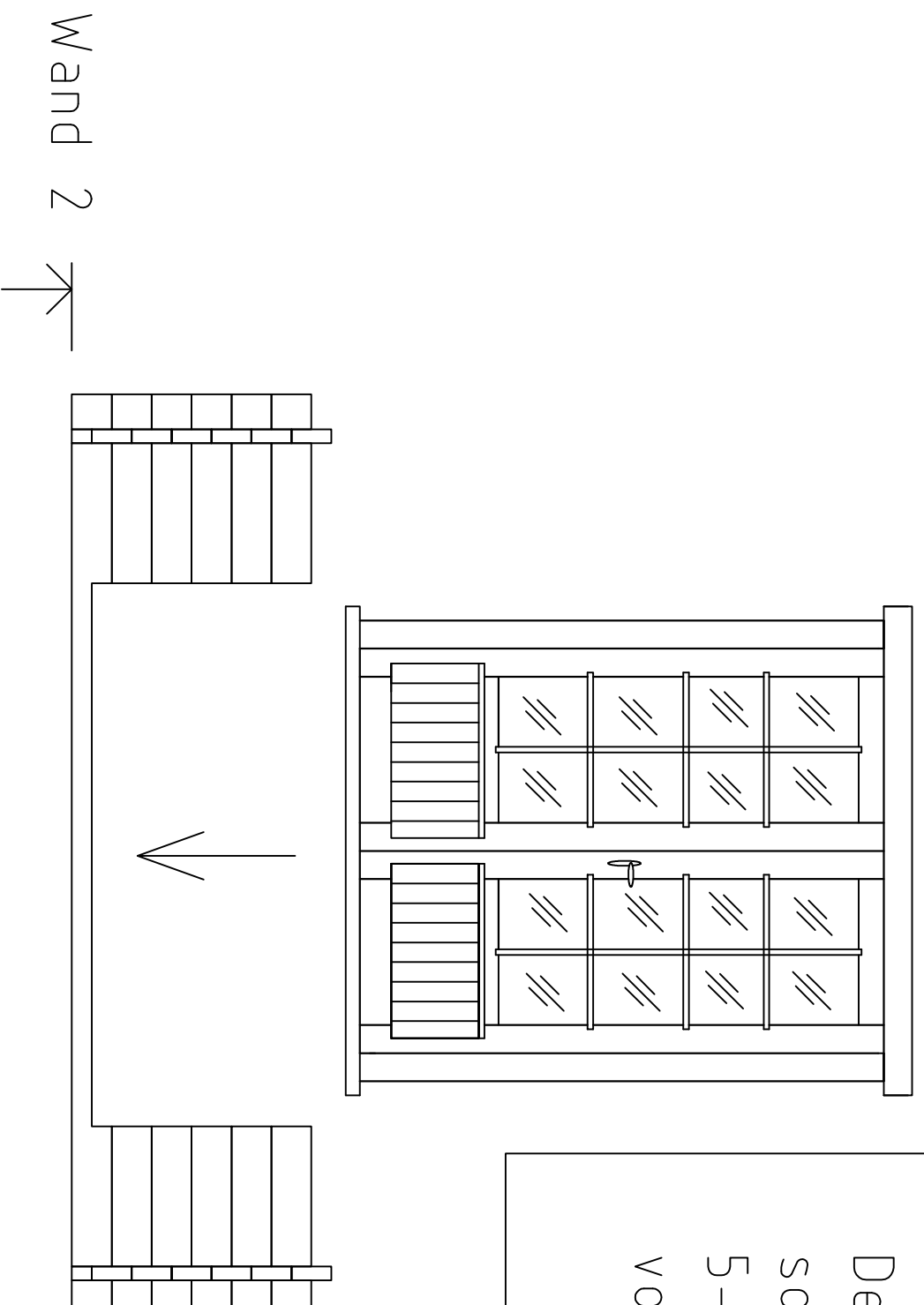



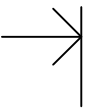

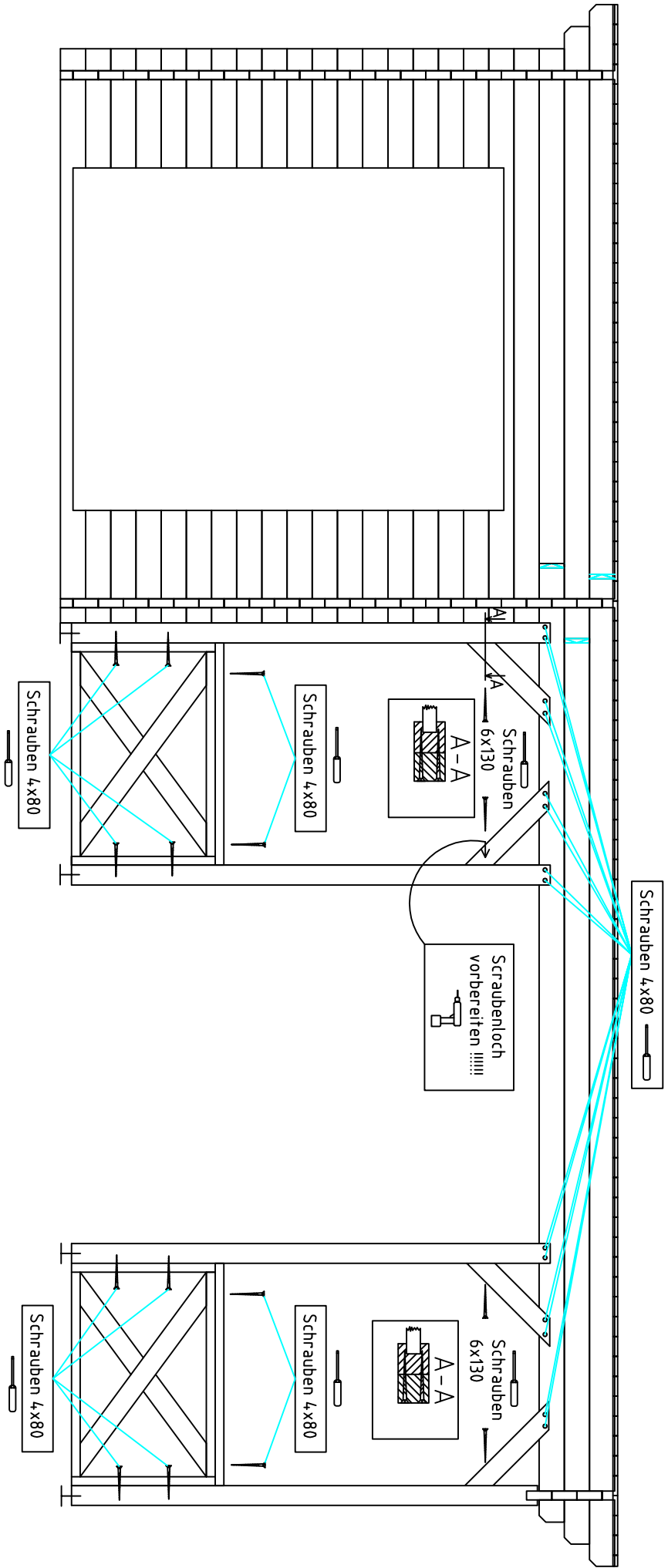

Wand 2

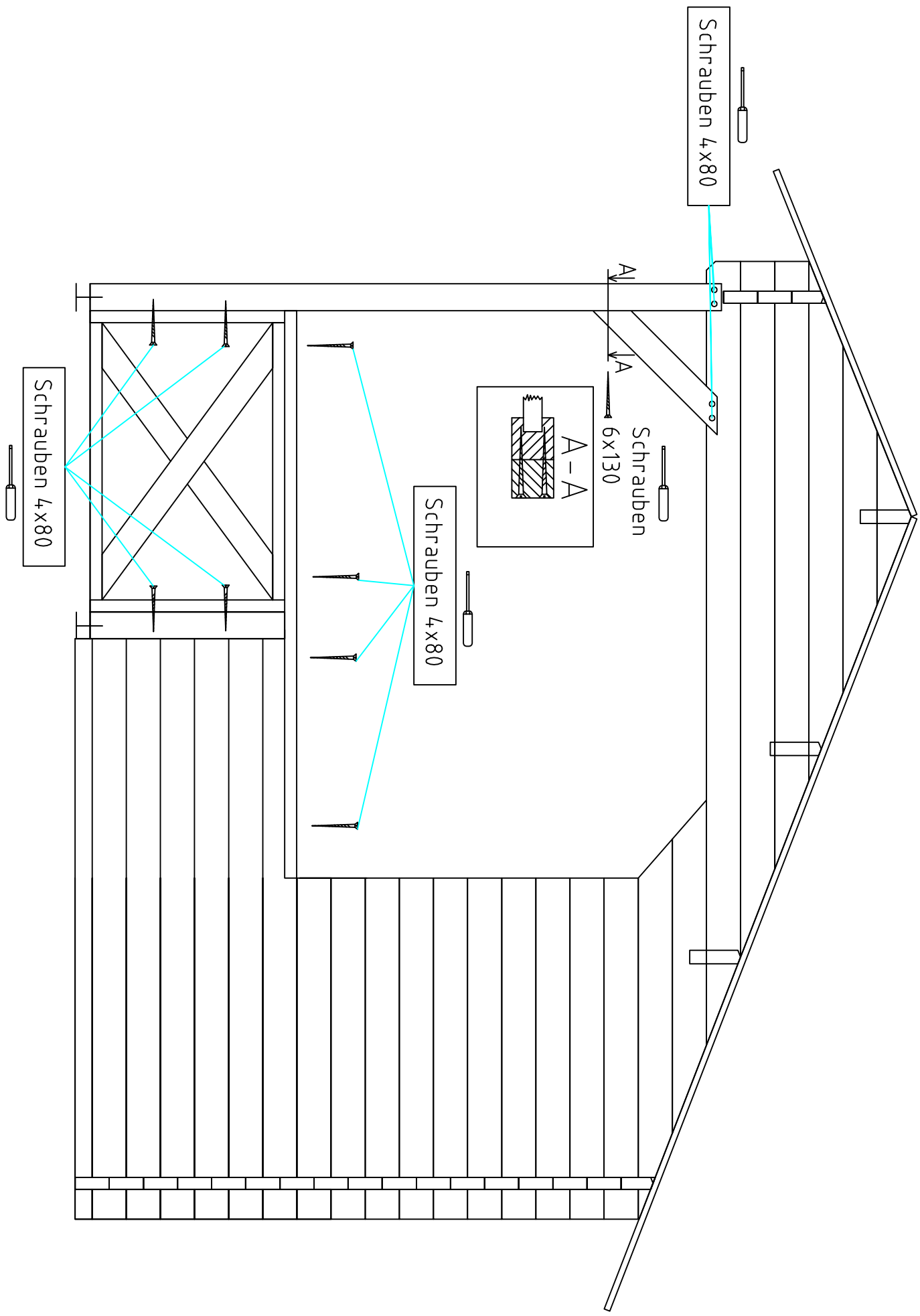

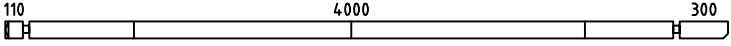
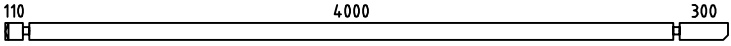
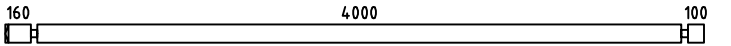
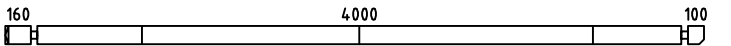
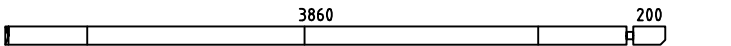
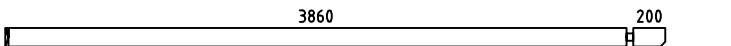
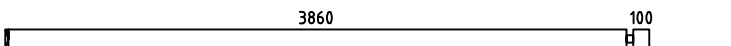
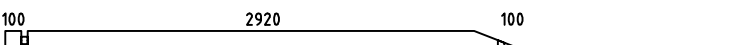
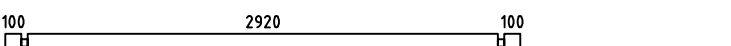
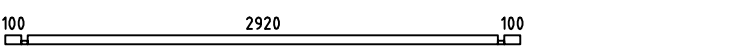
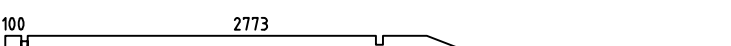

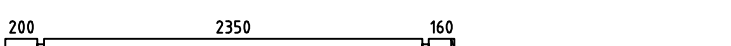
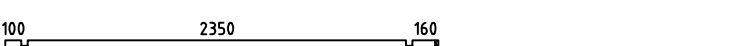



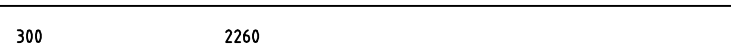
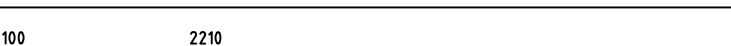
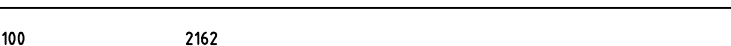
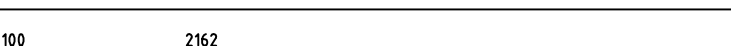
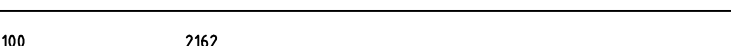
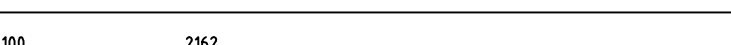
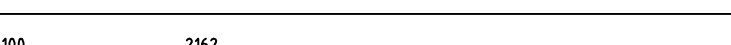

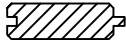

6732 / 40 / 22

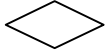
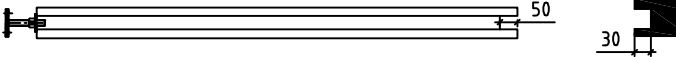

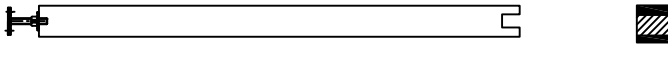
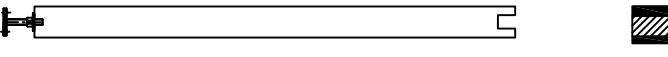
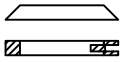

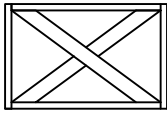
Pos	6732 / 40 / 22	ST	F (mm)	L (mm)	
001		NB!	1	40x106	4490
002		NB!	1	40x106	4490
003		8	40x114	4340	
004		1	40x114	4340	
005		1	40x114	4100	
006		1	40x114	4100	
007		7	40x114	4000	
008		2	40x114	3200	
009		32	40x114	3200	
010		2	40x57	3200	
011		1	40x114	2913	
012		1	40x114	2913	
013		2	40x114	2790	
014		7	40x114	2690	
015		1	40x114	2630	
016		1	40x114	2630	
017		1	40x114	2630	
018		NB!	1	40x106	2600
019		NB!	1	40x106	2600
020		9	40x114	2350	
021		1	40x114	2302	
022		1	40x114	2302	
023		1	40x114	2302	
024		1	40x114	2302	
025		2	40x114	2302	

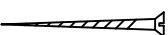
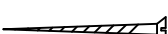
Pos	6732 / 40 / 22			ST	F (mm)	L (mm)
040	Dachbretter			79	90x20	2840
041				79	90x20	1240
042	Giebelbretter			2	20x120	1500
043				2	20x120	3100
044	Giebeldeckbretter			2	20x70	1500
045				2	20x70	3100
046	Traufenbrett			6	20x90	2400
047	Traufenleiste			6	50x50	2400
048	Giebelsegment			2		
049	Pfosten			1	90x90	2166
050	Pfosten			1	90x90	670
051	Pfosten			2	90x90	2166
052	Pfosten			1	90x90	2108
053	Träger			5	90x90	608
054	Handlauf			1	90x40	1895
055				2	90x40	1006
056	Barrieren			3		
G1	Gewindestift12			3		390
057	Dübel			21	11,5x11,5	
058	Schrauben			60	4,0x80	
059	Schrauben			70	6,0x130	

Doppeltür

Beschlag:

Türklinken mit der Lasche = 1 Kmp.

Schraube 5x80mm = 4 St.

Schnepper mit Schlüsseln = 1 Kmp.

Metalblechen (zwei St.) Pos. 5,
befinden sich auf untere oder
obere Türflügelkante.

Schrauben 5x80

Schrauben 5x80

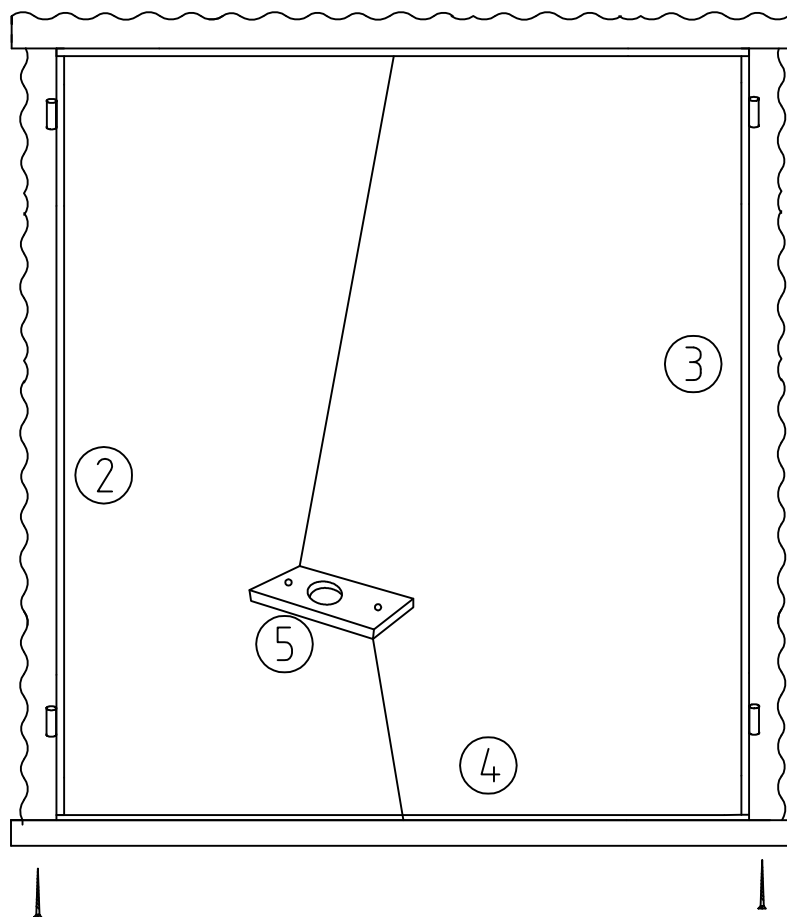

Schrauben 5x80

Schrauben 5x80