

2555 / 28 / 22

2555 / 28 / 22

2300

2244

236

236

90x67

117.6x197

236

236

90x67

2244

2300

A

B

2

1

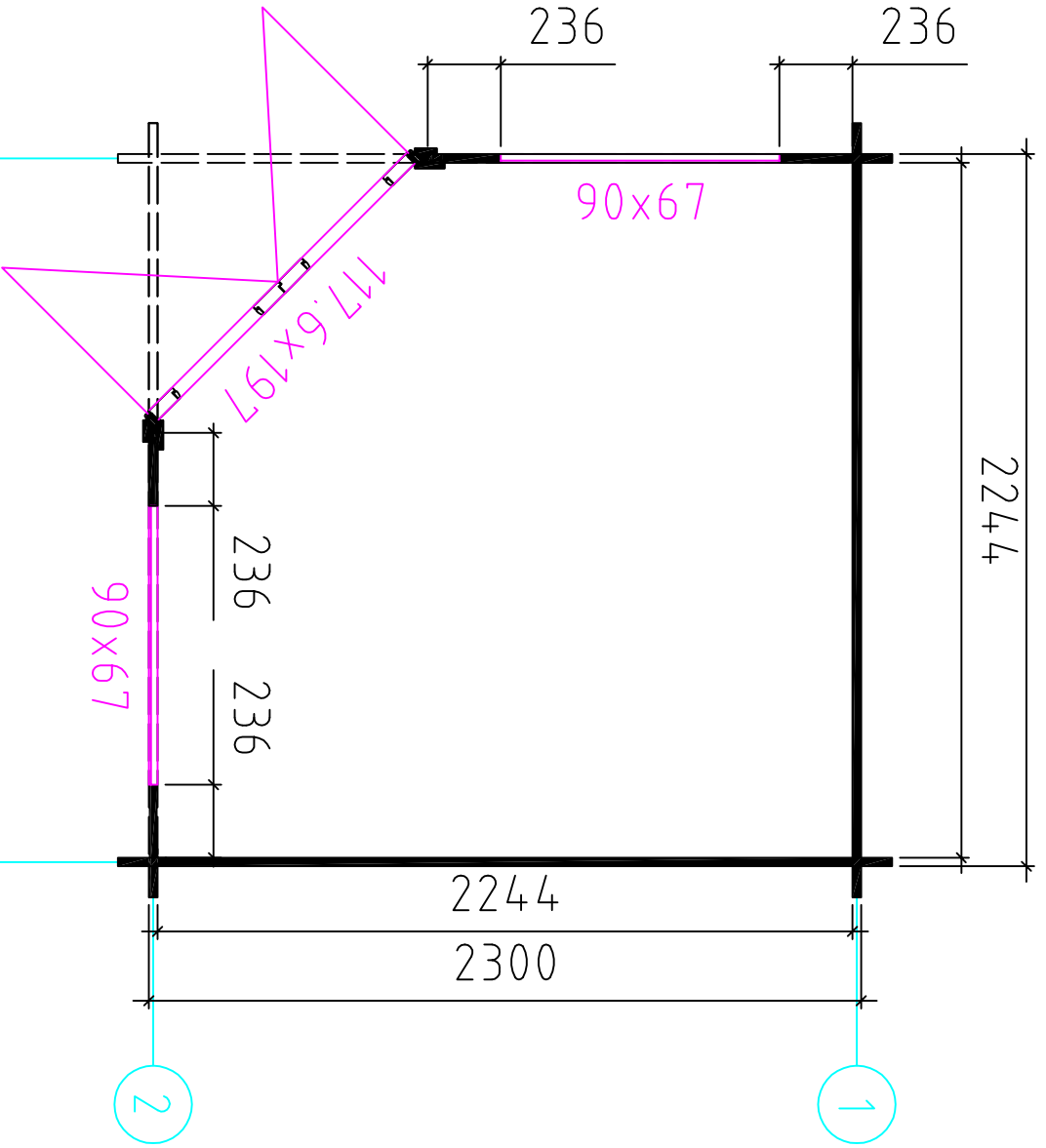

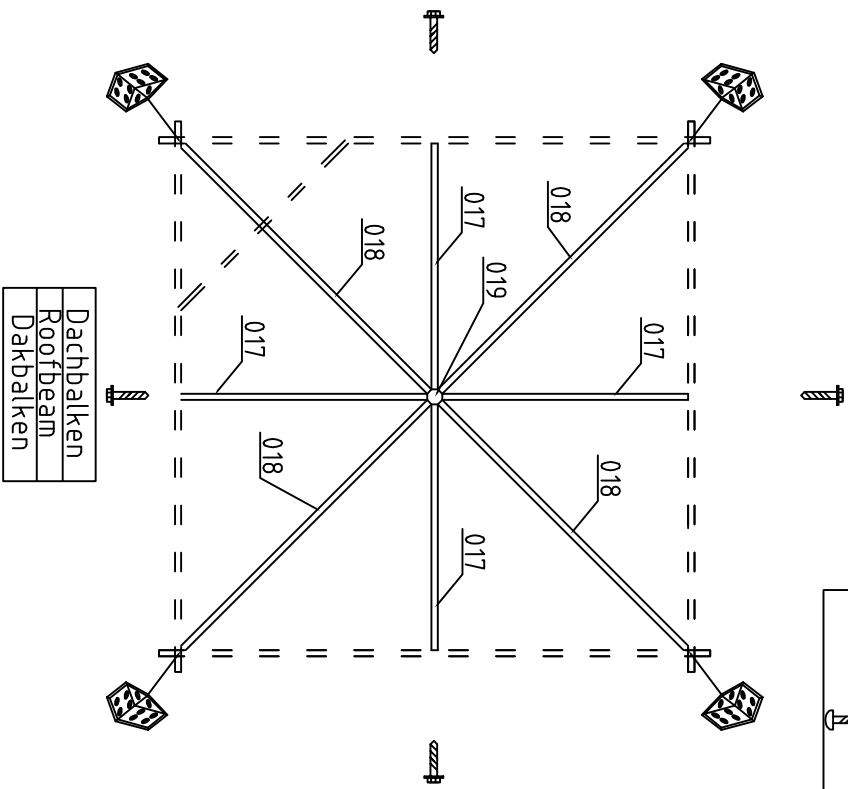
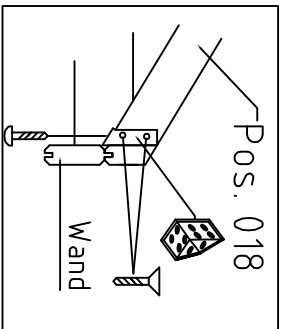





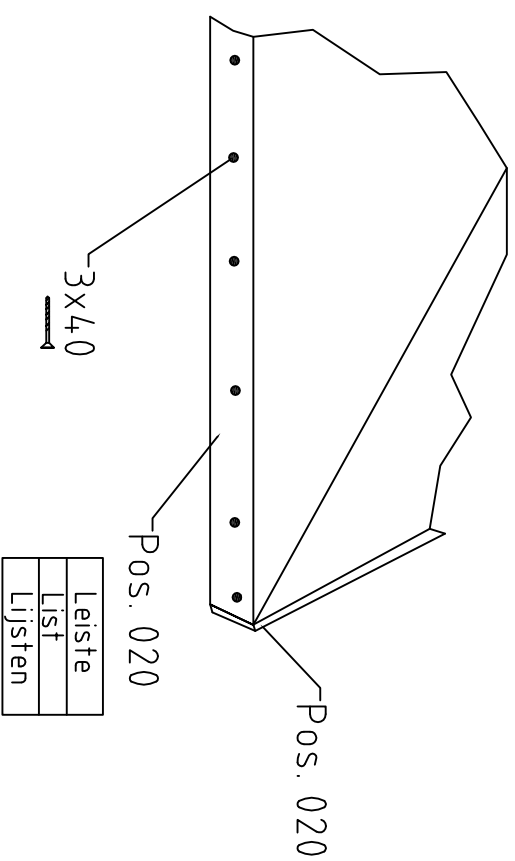
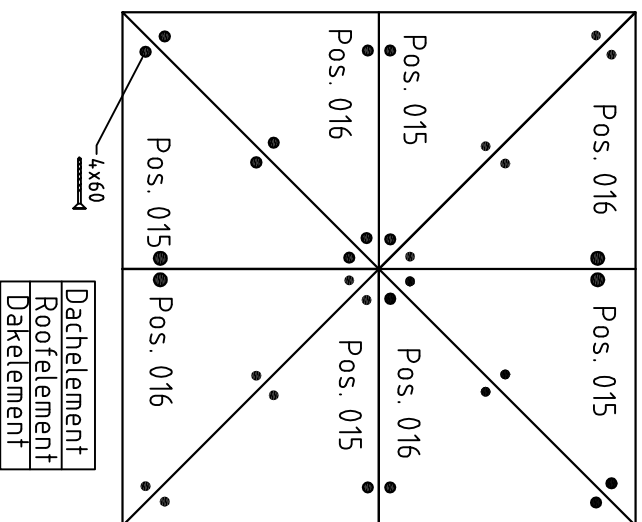

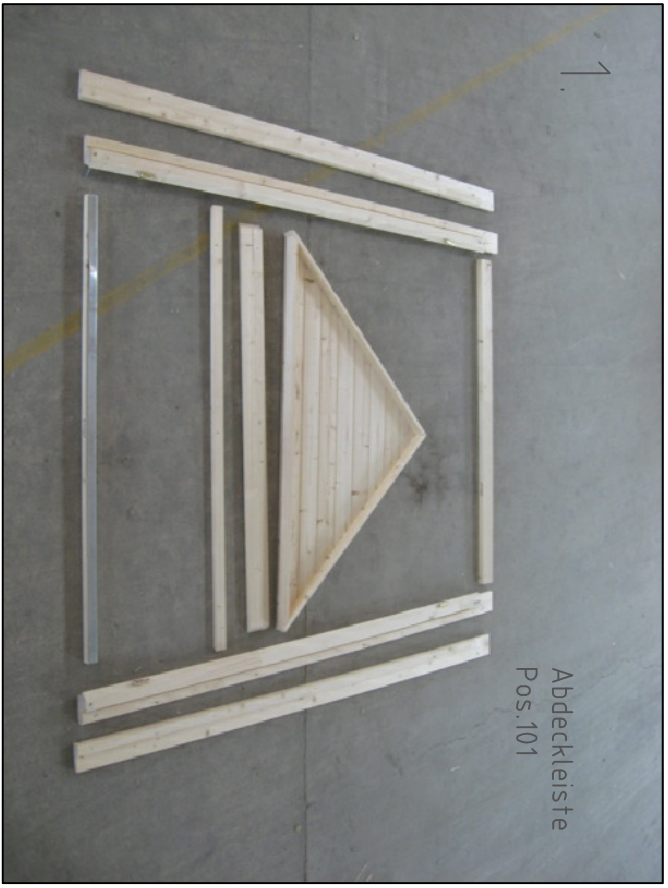

Dachbalken
Roofbeam
Dakbalken

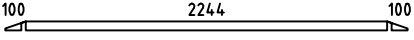
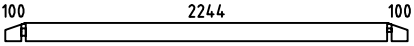
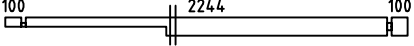
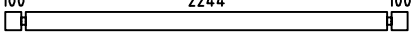
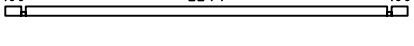
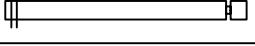
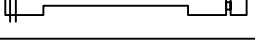
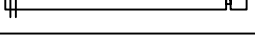
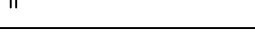



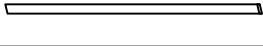

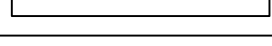
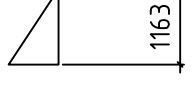
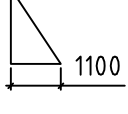

Pos	2555 / 28 / 22		ST	F (mm)	L (mm)
001			2	28x57	2500
002			2	28x114	2500
003			1	28x114	2500
004			37	28x114	2500
005			1	28x57	2500
006			21	28x114	1500
007			1	28x114	1500
008			1	28x114	1500
009			1	28x57	1500
010			11	28x114	364
011			11	28x114	236
017		SA1	4	40x58	1156
018		SA2	4	40x58	1594
019	Firstelement 		1		
020	Leiste 		4	20x50	2900
021	Dachelement 		4	1350x1428	
022	Dachelement 		4	1350x1428	
023	Giebelelement 		1	832x832	

