

4355+2 / 40 / 11

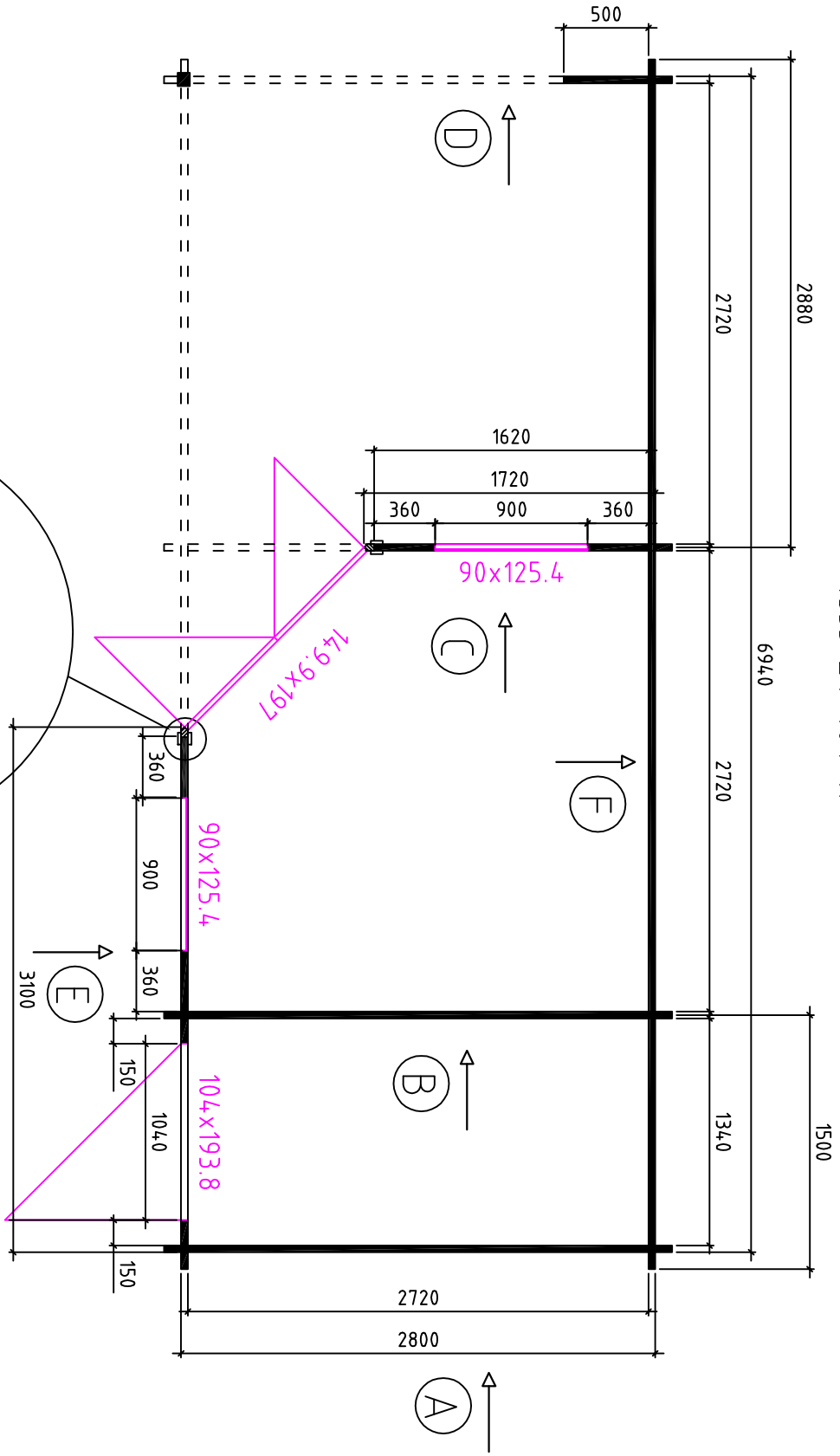

4355+Z / 4.0 / 11

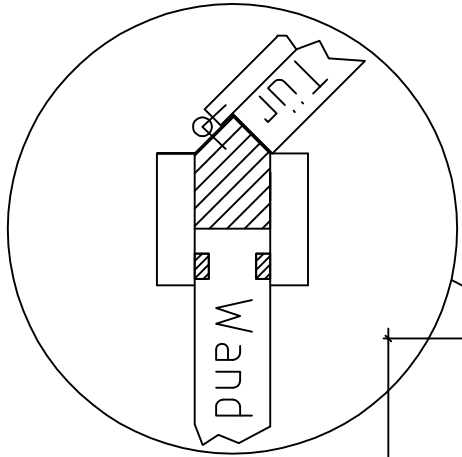
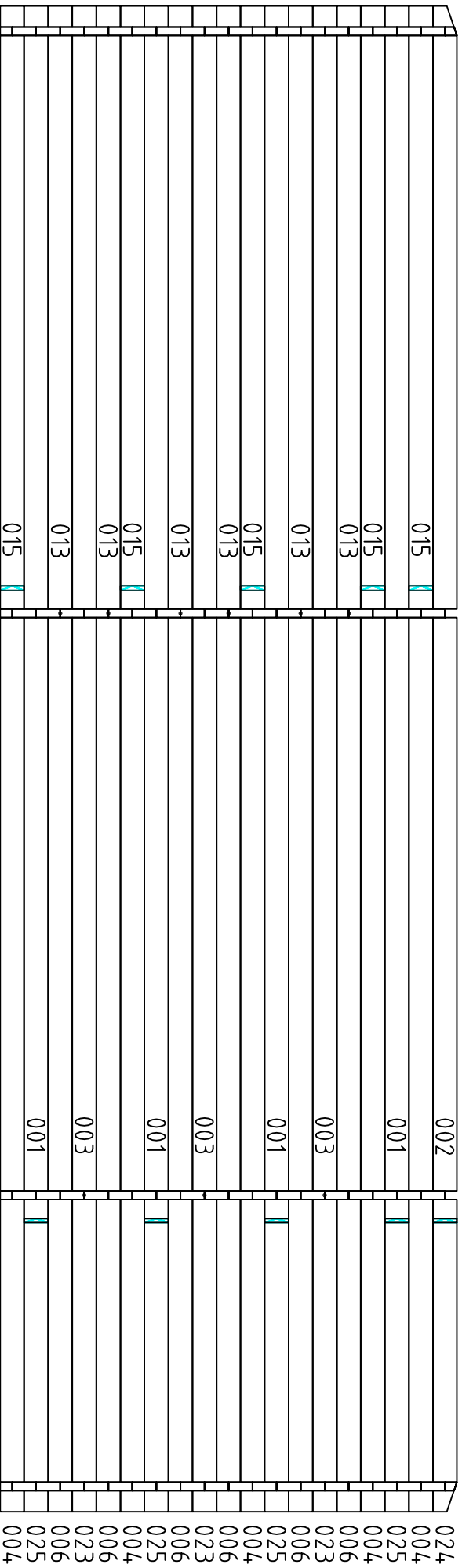

4 355+Z / 40 / 11

F

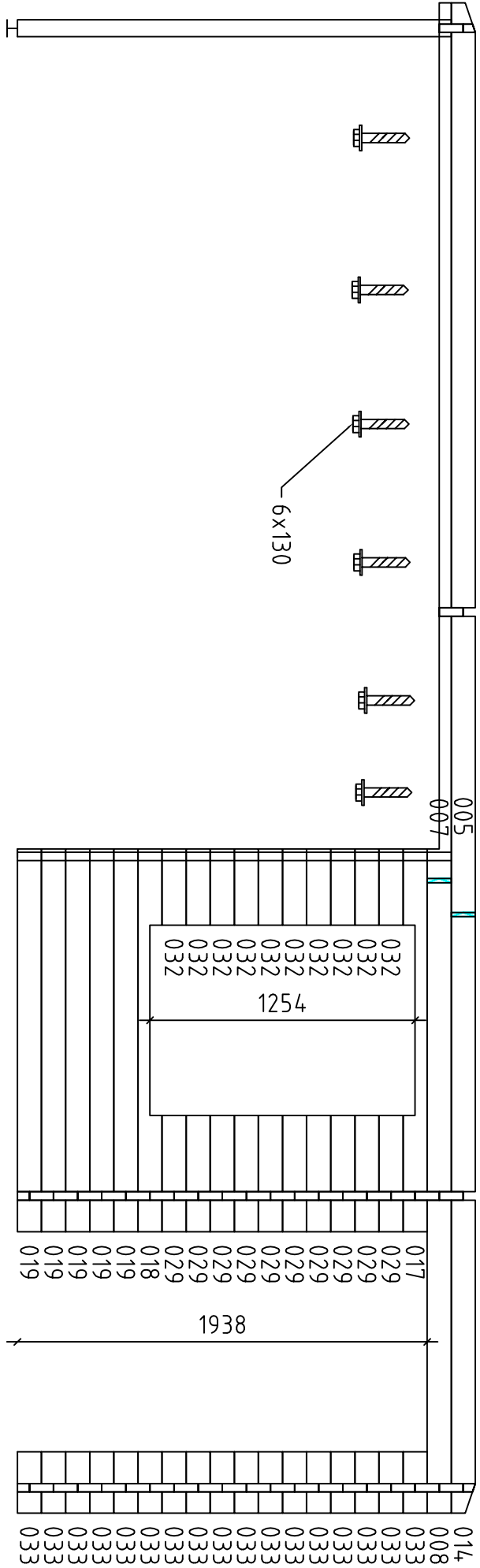

4 355 + Z / 40 / 11

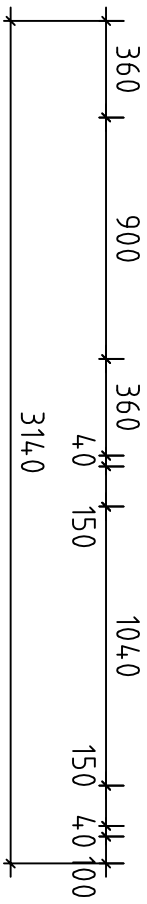

(E)

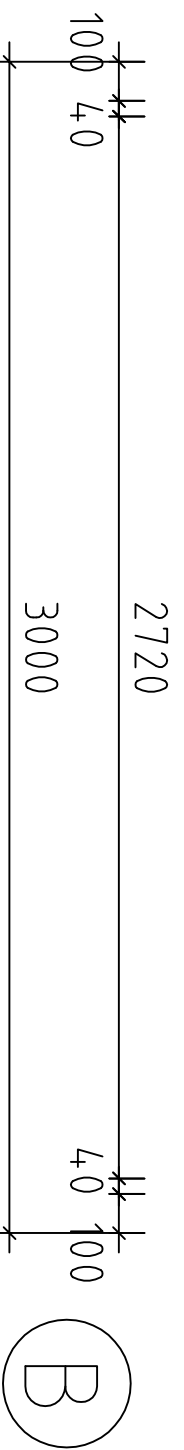
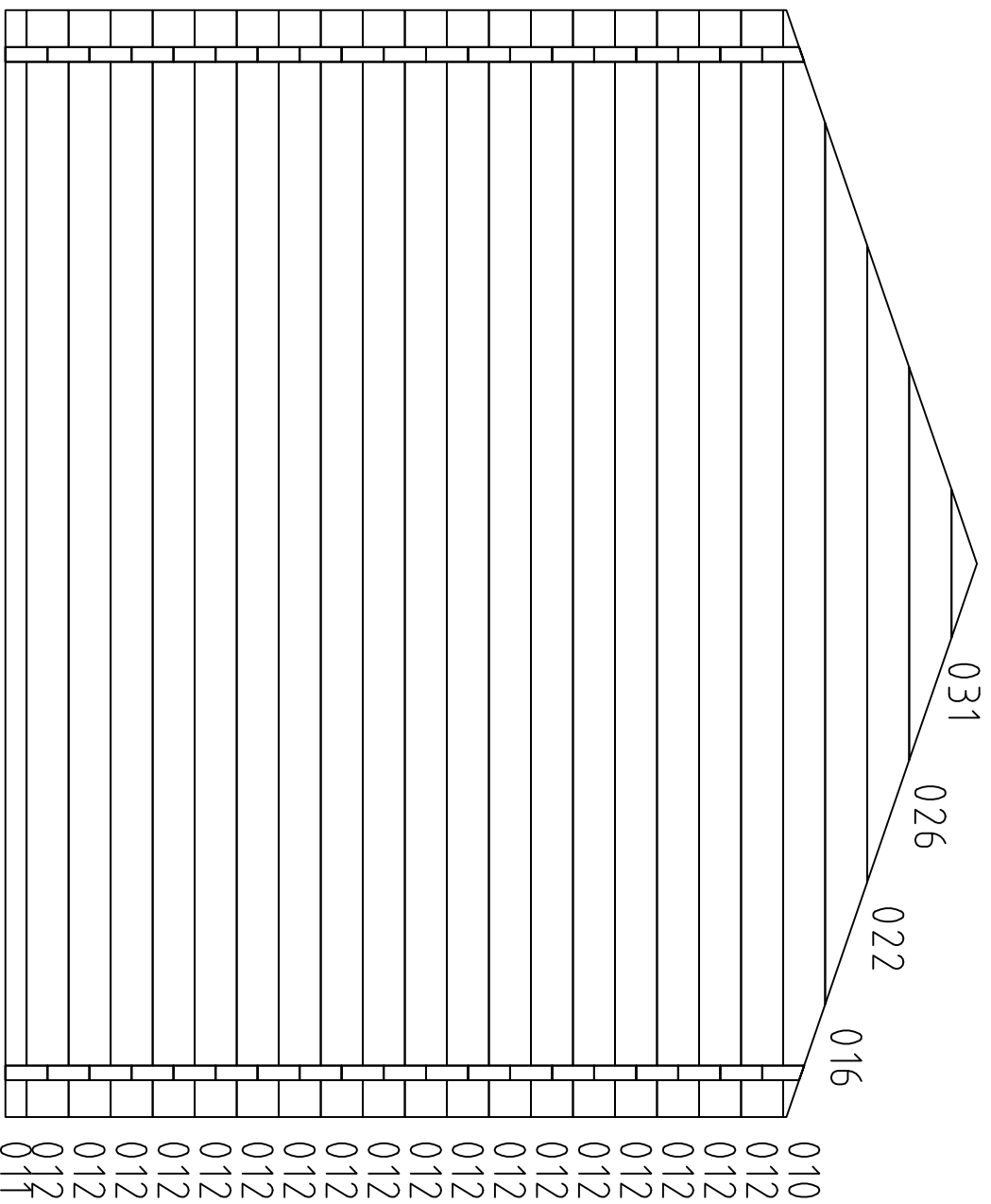

4355+Z / 40 / 11

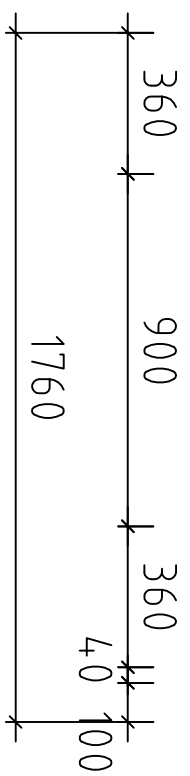
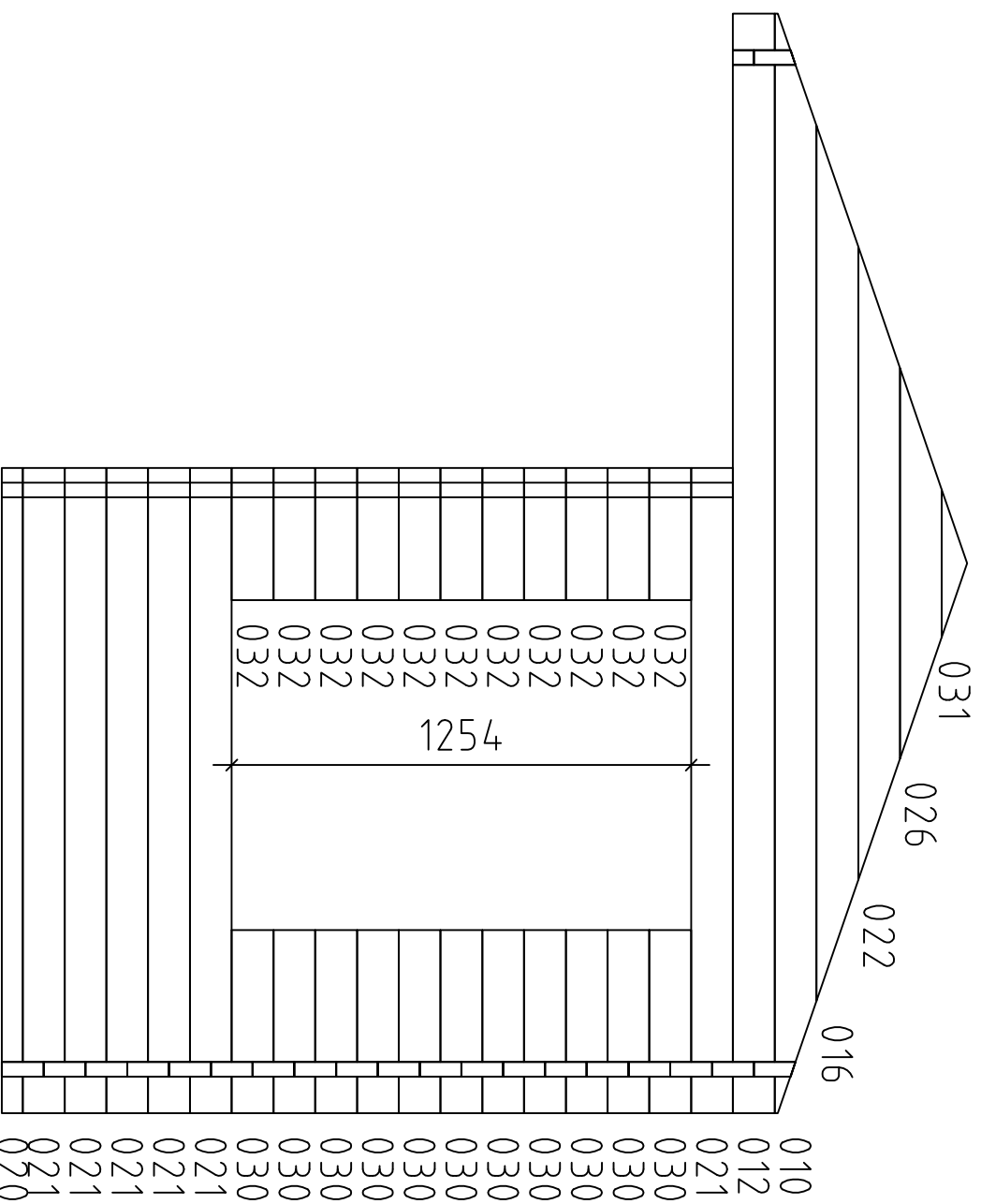

$$4355 + Z / 40 / 11$$

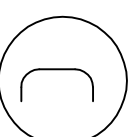

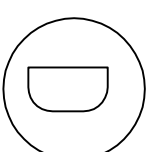
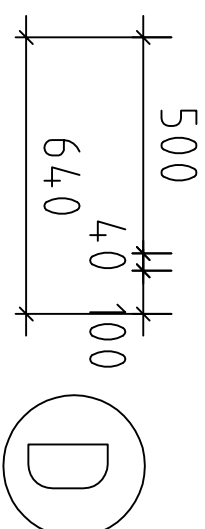
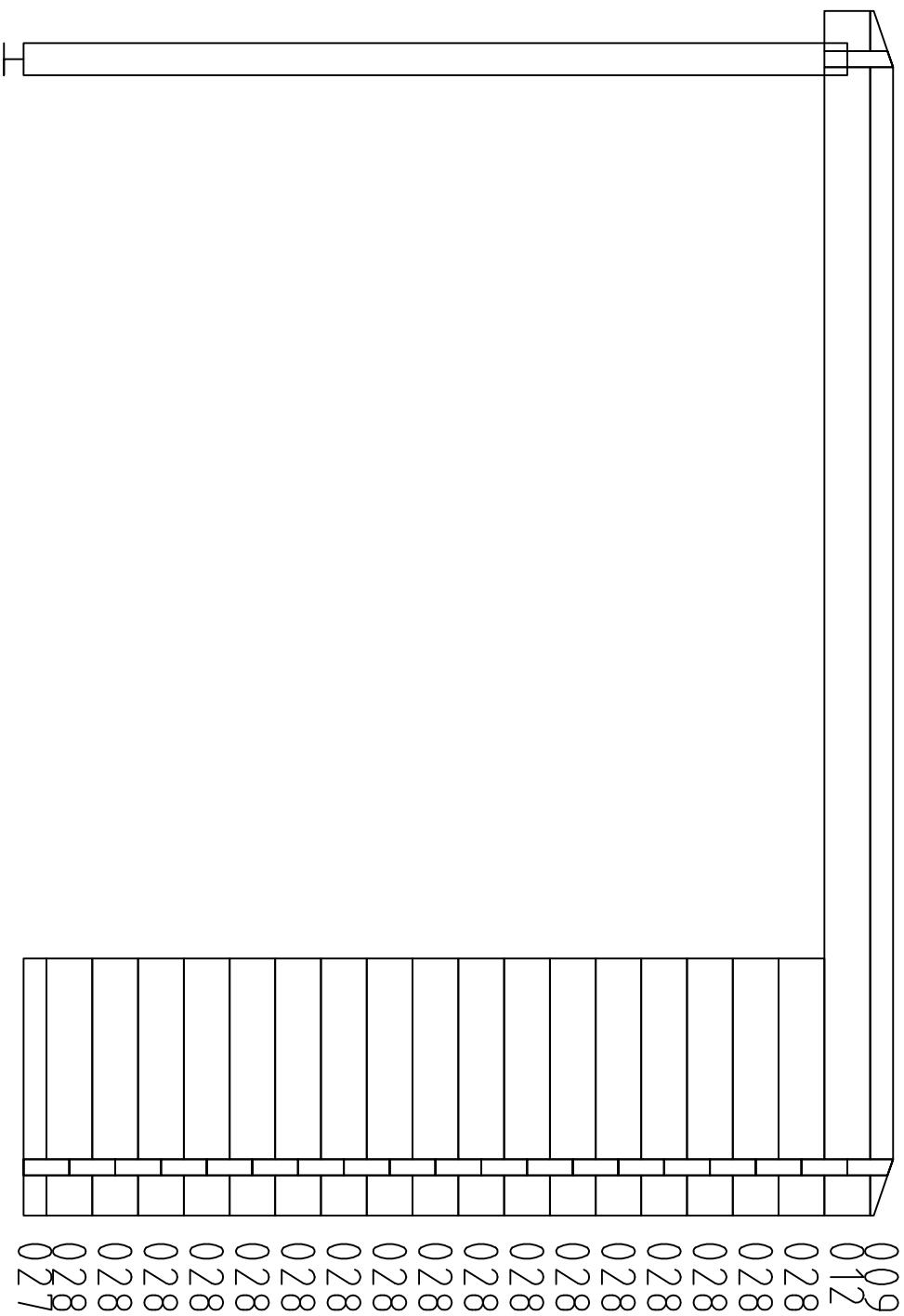



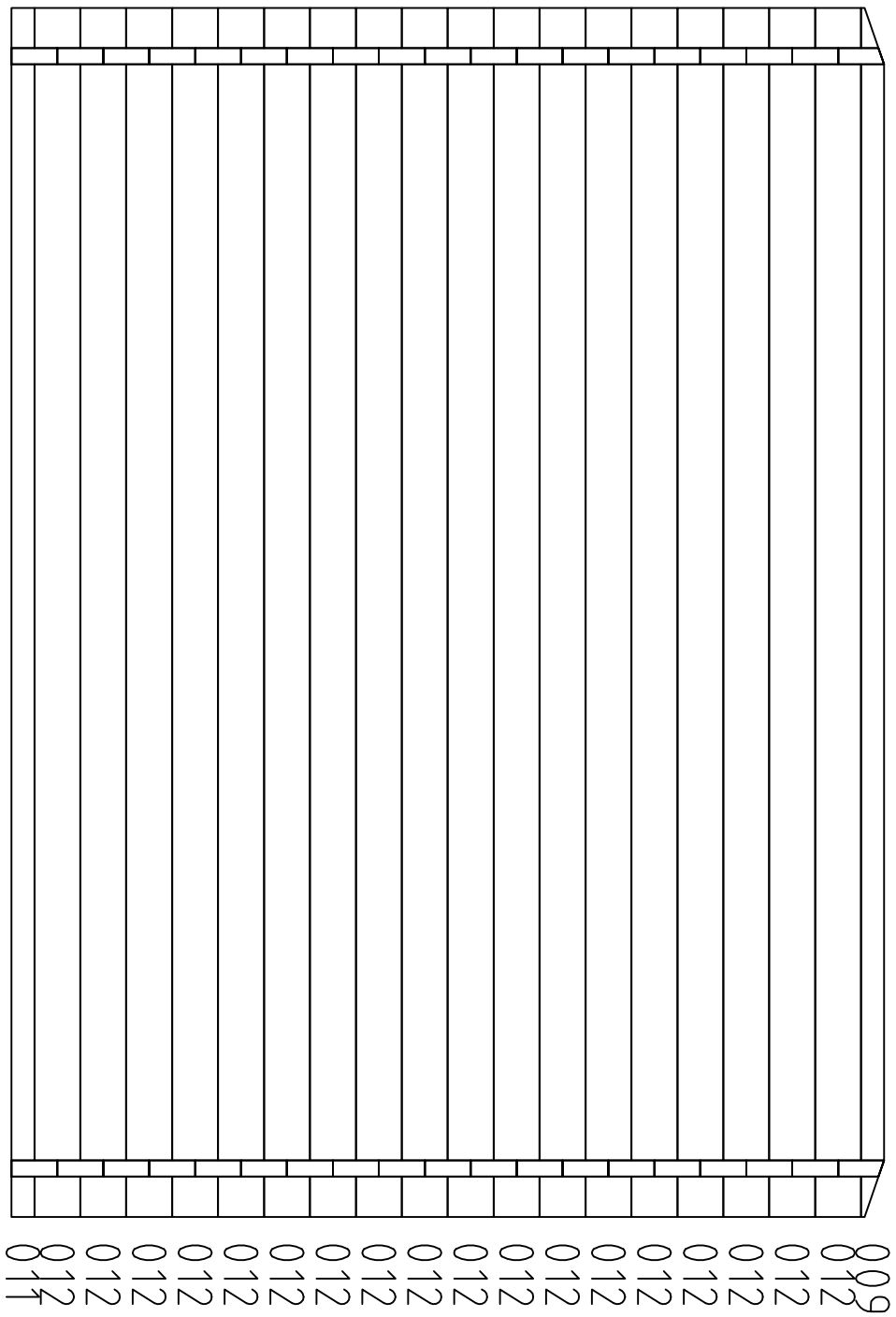



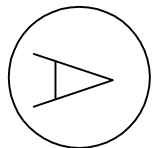

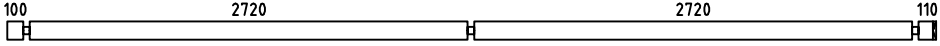
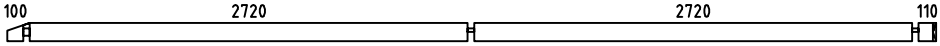
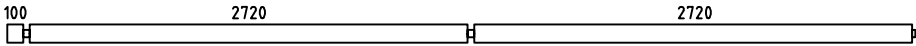
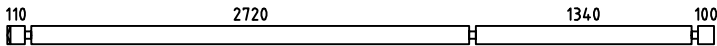
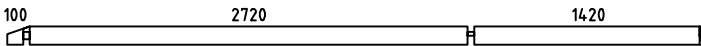
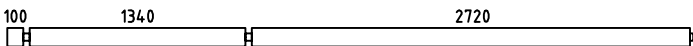
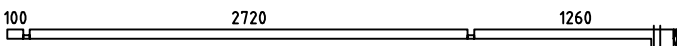

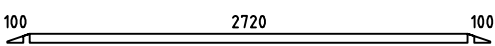
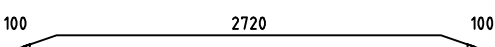
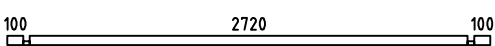
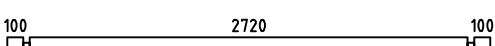
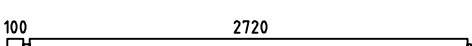
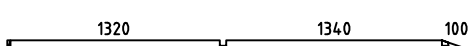
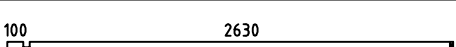
4355+Z / 40 / 11

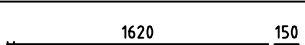
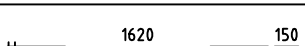
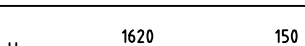
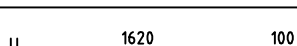
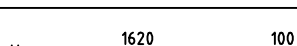
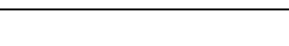
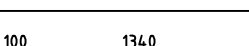
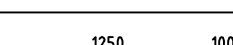
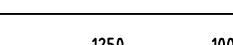



4 355+Z / 40 / 11

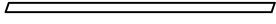
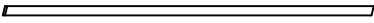
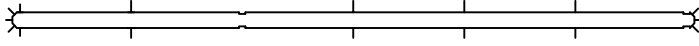
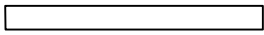
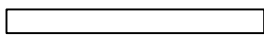
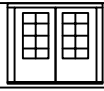

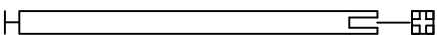
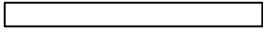
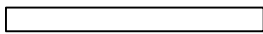
Pos	4355+Z / 40 / 11	ST	F (mm)	L (mm)
001		4	40x114	5770
002		1	40x114	5770
003		3	40x114	5640
004		5	40x114	4390
005		1	40x114	4320
006		6	40x114	4260
007		1	40x114	4160
008		1	40x114	3000
009		2	40x57	3000
010		2	40x114	3000
011		2	40x57	3000
012		38	40x114	3000
013		6	40x114	2880
014		1	40x114	2840
015		5	40x114	2770
016		2	40x114	2389
017		1	40x114	1810
018		1	40x114	1810
019		5	40x114	1810
020		1	40x57	1760
021		6	40x114	1760
022		2	40x114	1727
023		3	40x114	1500
024		1	40x114	1390
025		4	40x114	1390

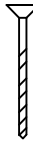
Pos	4355+Z / 40 / 11			ST	F (mm)	L (mm)
034	Giebelelement Frontelement Gevelelement			1	1060x1060	
035	Dachelement Roofelement Dakelement			4	1595x1685	
036	Dachelement Roofelement Dakelement			4	1595x1685	
037	Dachelement Roofelement Dakelement			12	690x1695	
038	Dachbalken Roofbeam Dakbalken			12	40x58	1408
039	Dachbalken Roofbeam Dakbalken			4	40x58	1941
040	Dachbalken Roofbeam Dakbalken			1	97x65	4236
041	Leiste List Lijsten			2	20x70	3400
042	Leiste List Lijsten			4	20x70	4200
043	Doppel Tür Double door Dubbele deur 1499x1970		Klaas 551x1062 2tk Roostevaba plekk 1498x28x34	1		
044	Fenster Window Ramen 900x1254		Klaas 1062x727	2		
045	Tür Door Deur 1040x1938			1R		
046	Pfoste			1	90x90	2022
100	Abdeckleiste List Lijsten			1	20x50	1580
101	Abdeckleiste List Lijsten			1	20x90	1499

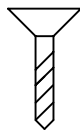
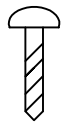
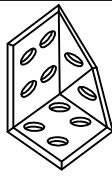
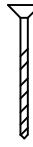
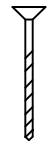
	3x40	4x80	5x16	5x16		4x60	6x130
Beslag Beschlag Metalworks							
"Blokhuut"	80 st.	12 st.	16 st.	8 st.	4 st.	170 st.	6 st.

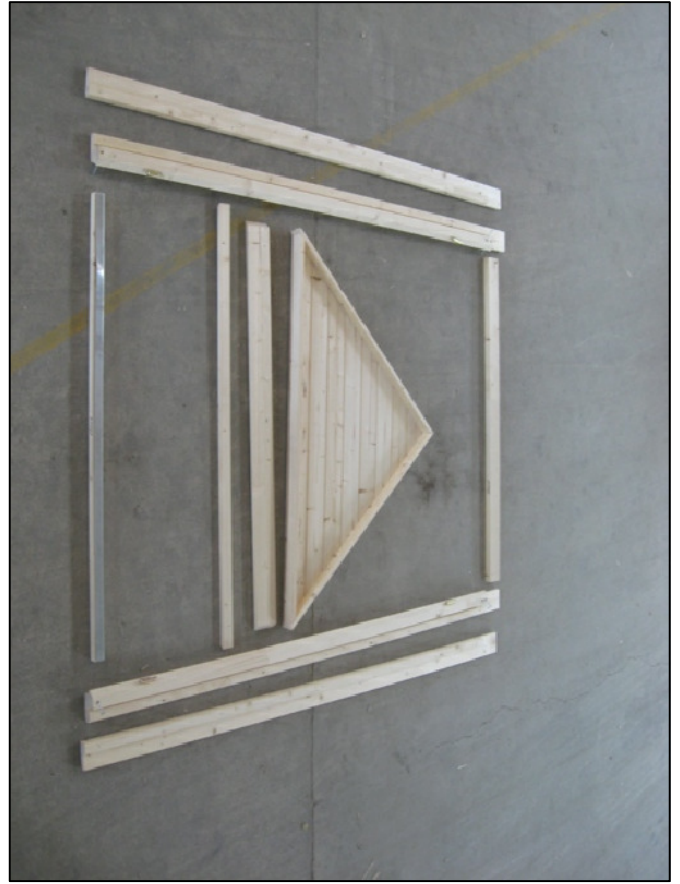



4355+Z / 40 / 11

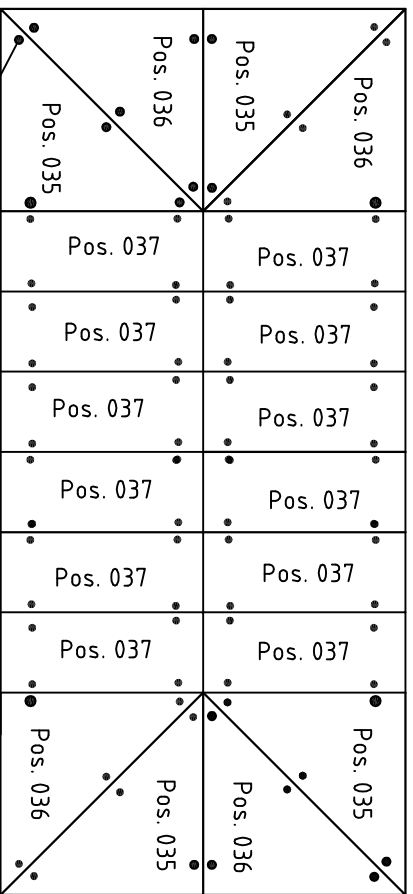

Dachelement
Roofelement
Dakelement

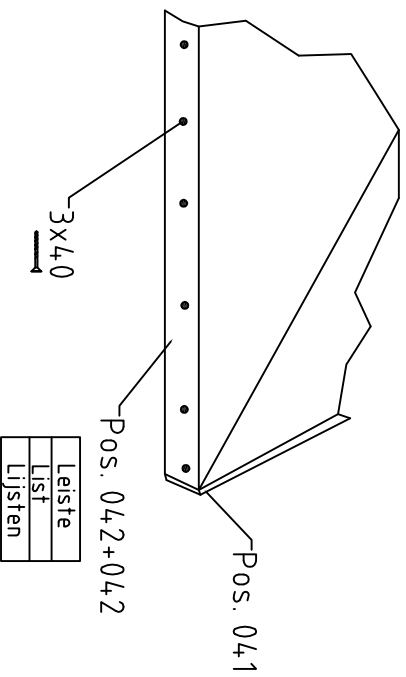

Dachbalken
Roofbeam
Dakbalken

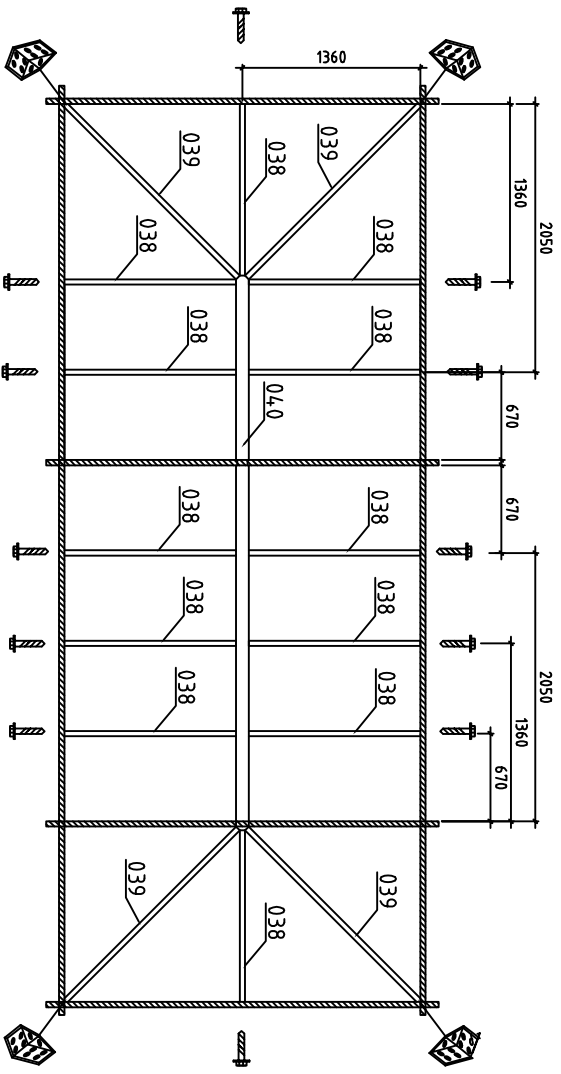

4.355+Z / 4.0 / 11

