

Bemerkung: die Ansicht von Turen, Fenster und anderen Teilen kann abweichen von diesem Bild

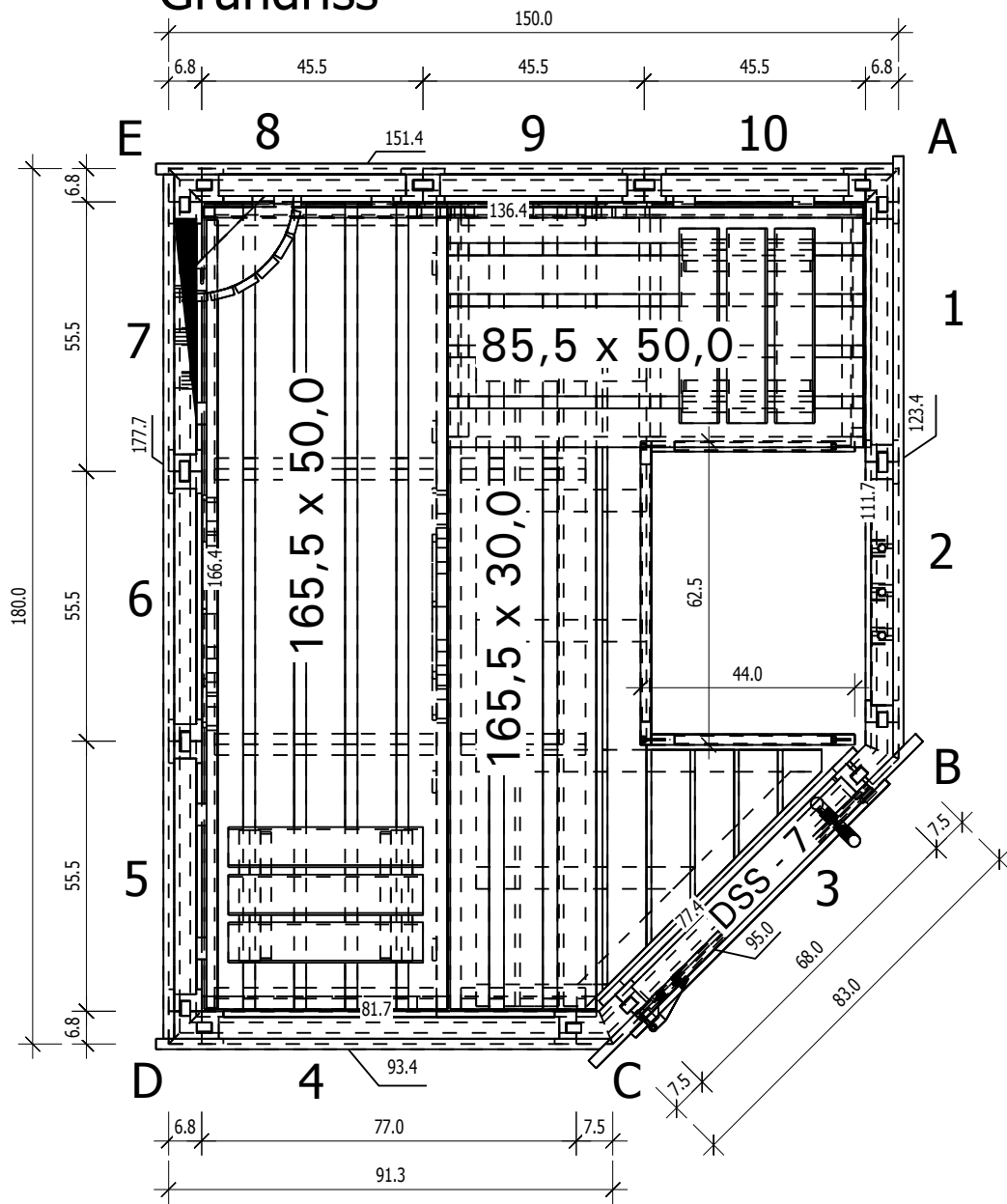

Grundriss



Schnitt

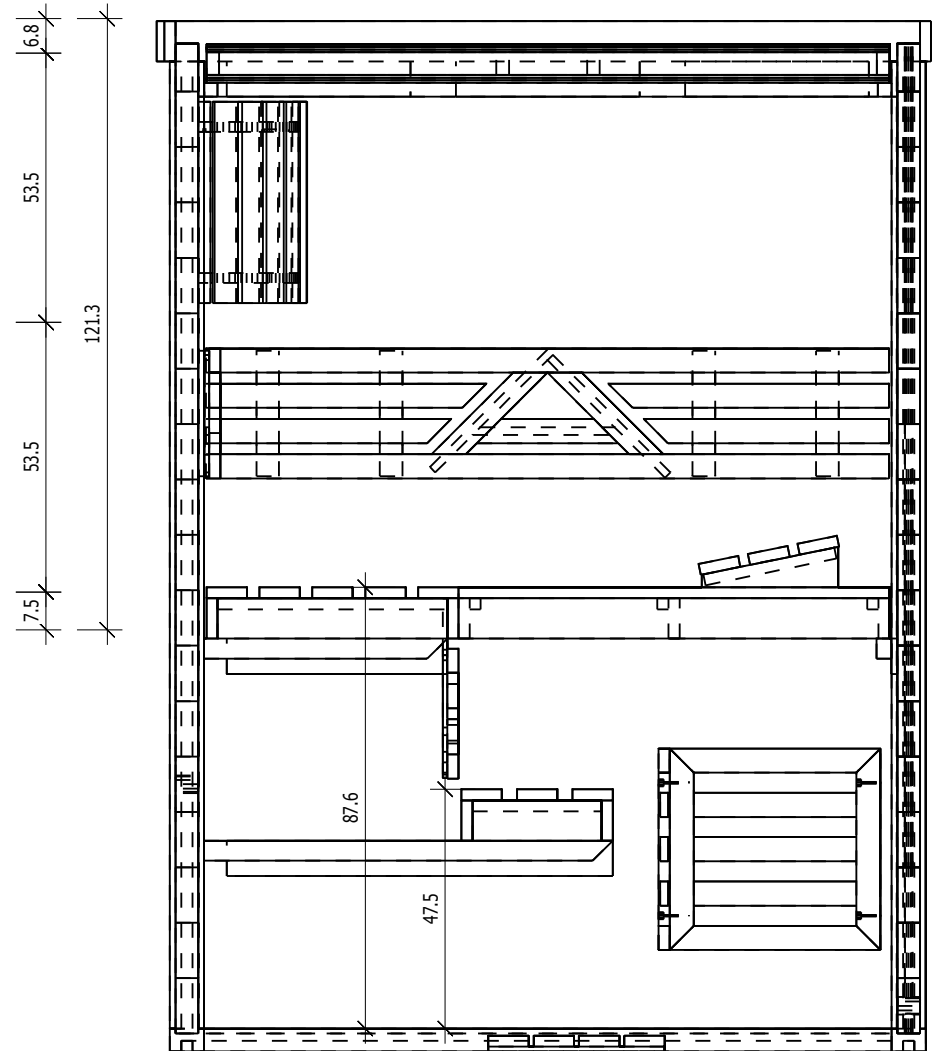

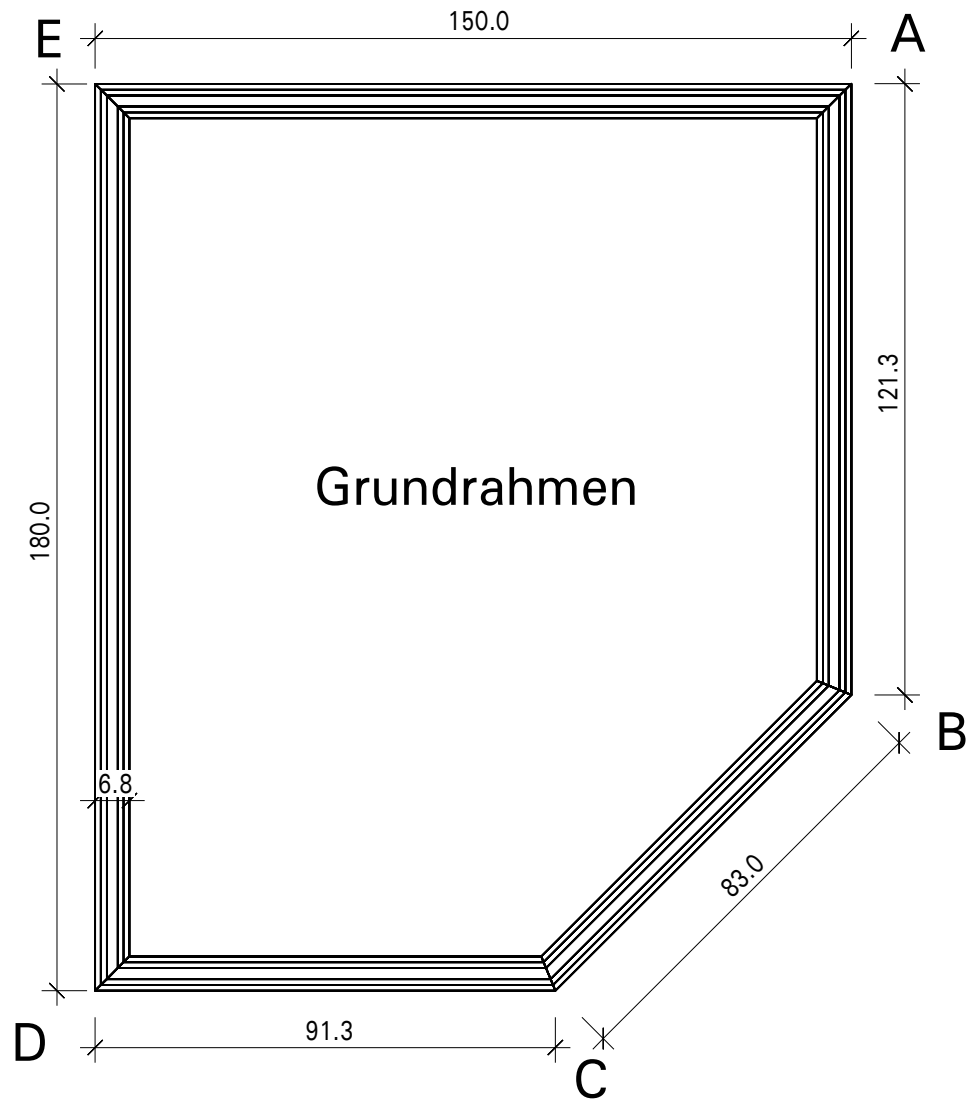

Dachelemente

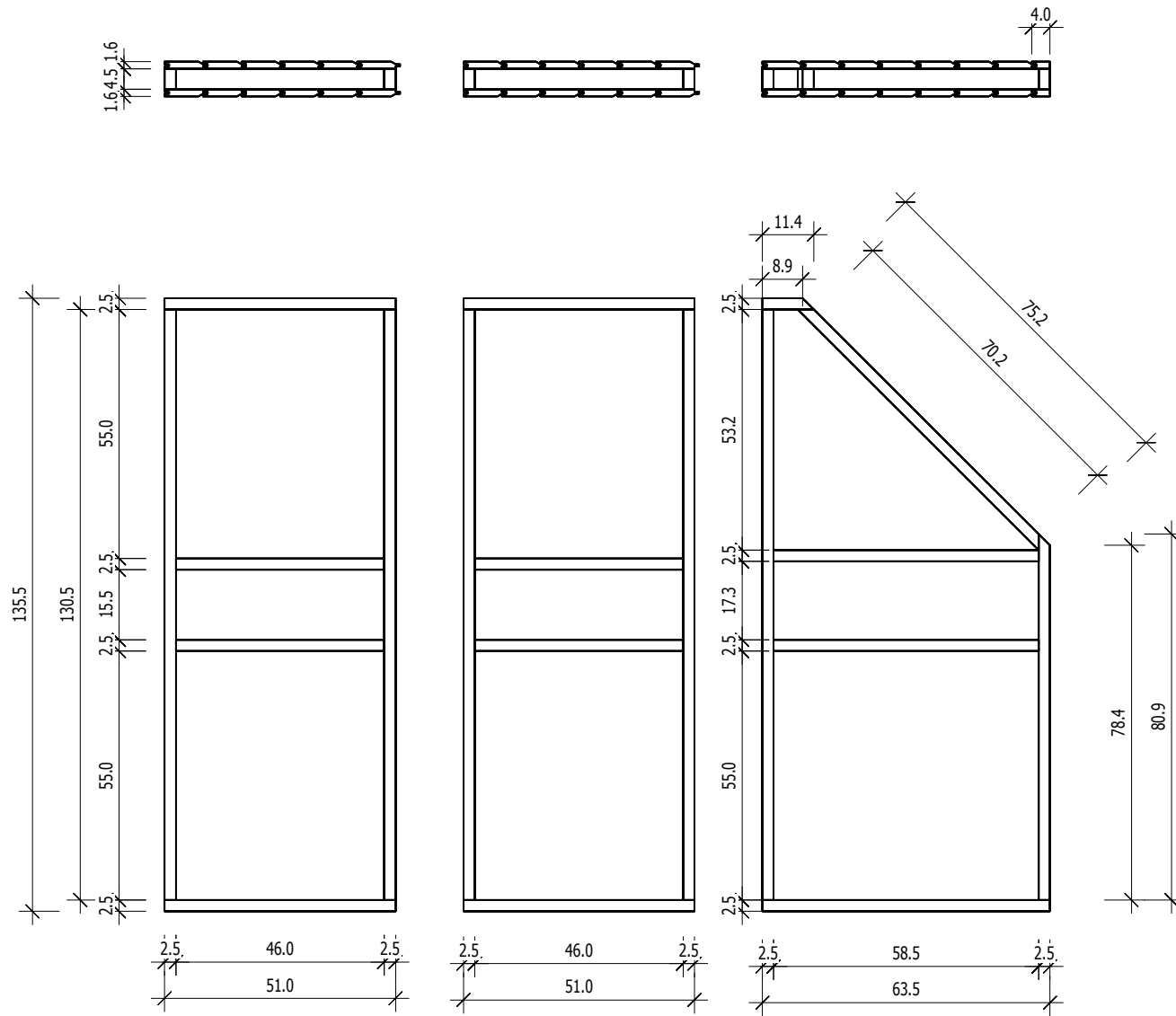

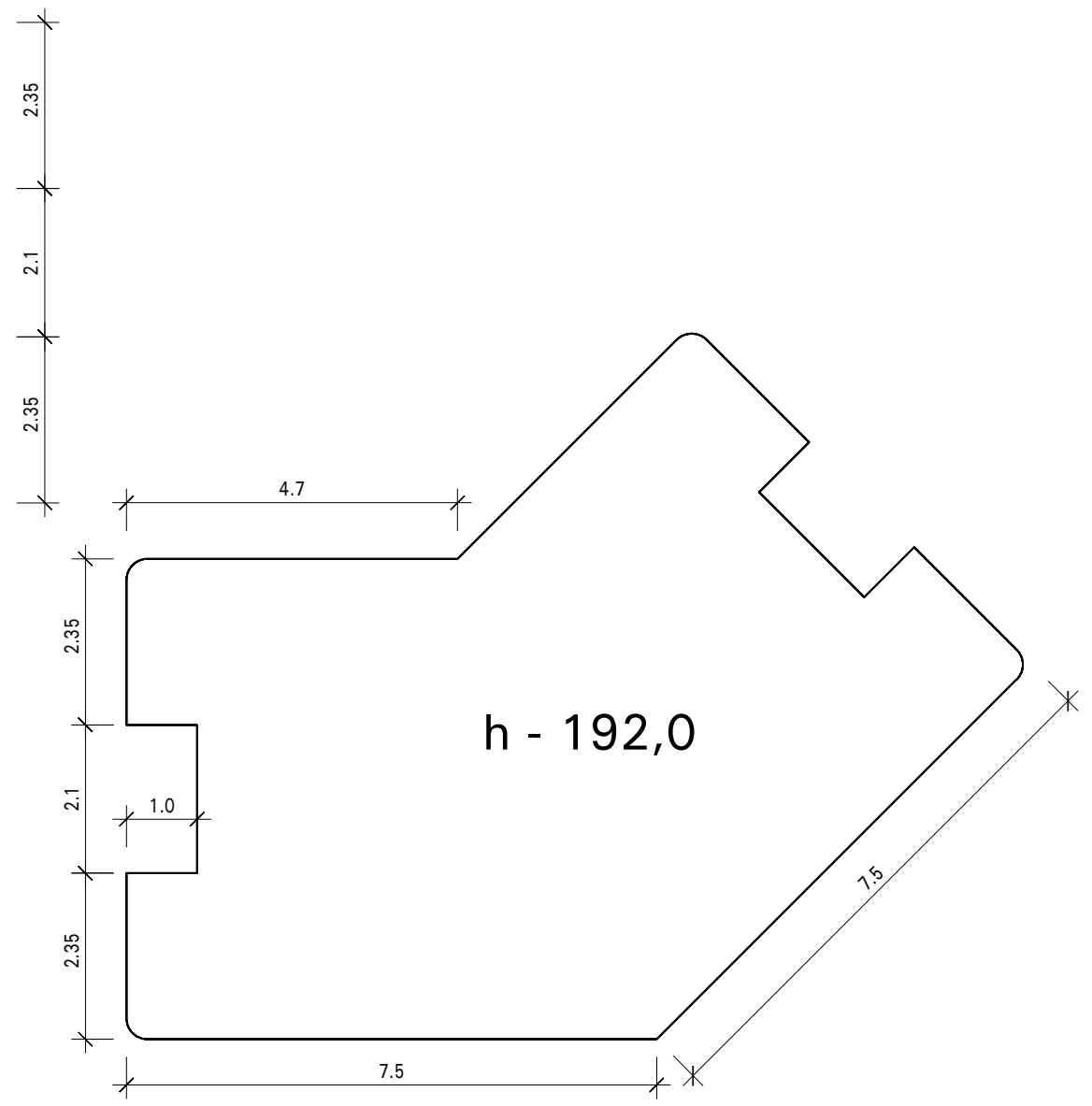
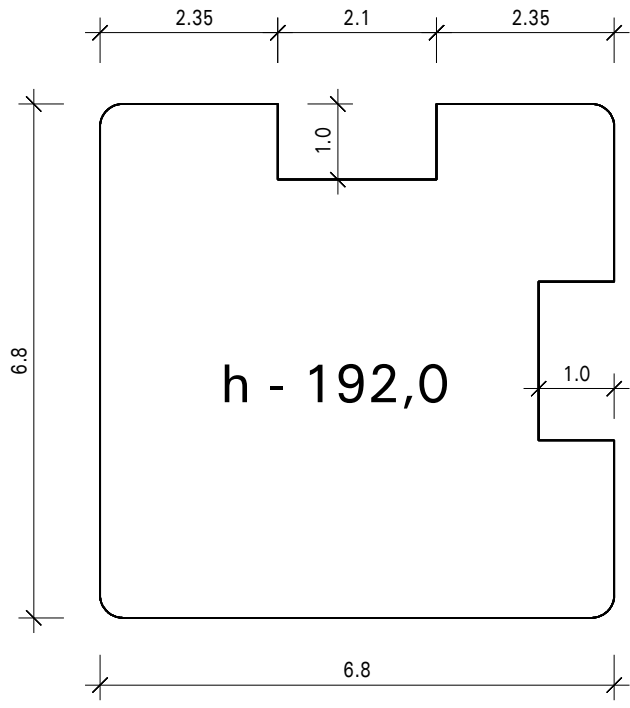

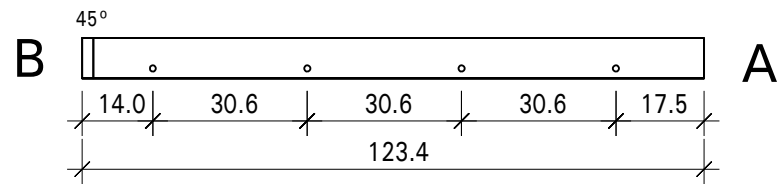
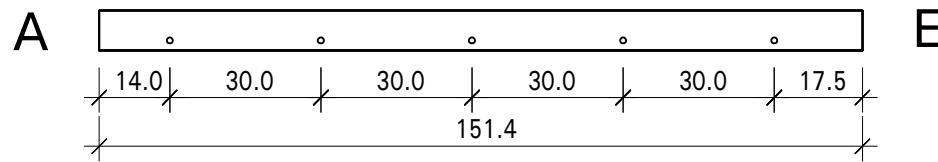
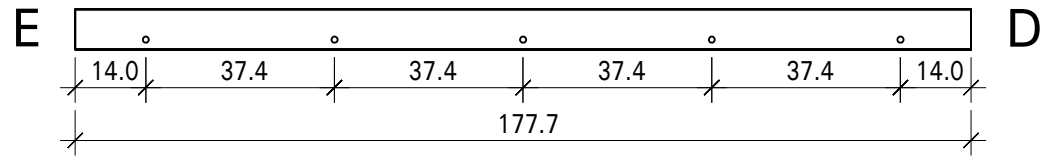
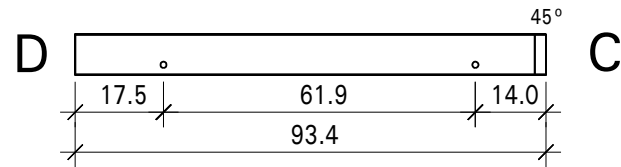
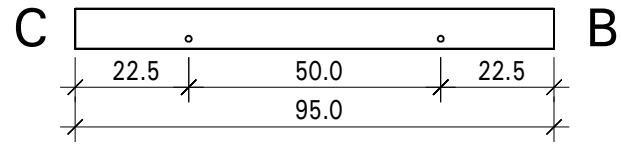

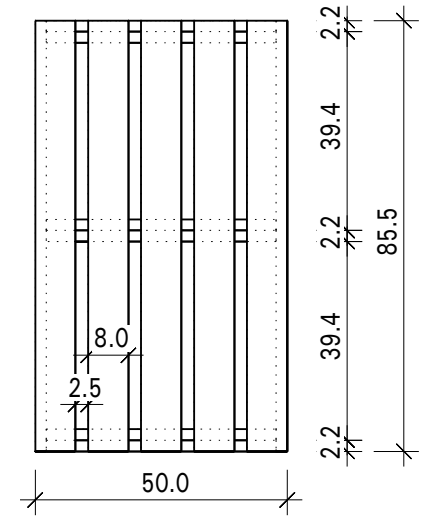
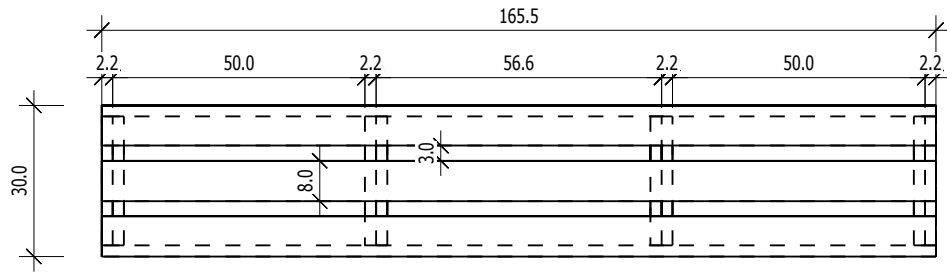
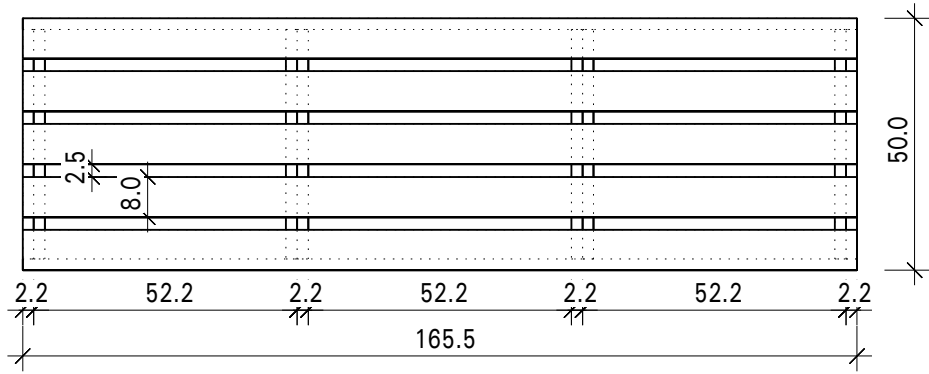

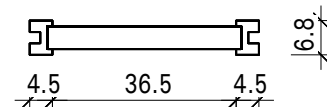
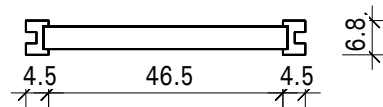
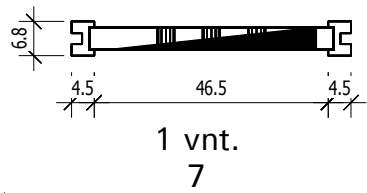
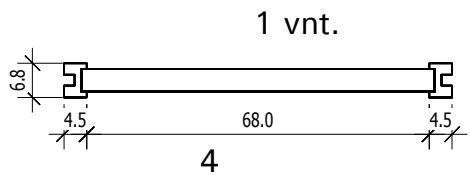

2 vnt.
5,6

3 vnt.
8,9,10

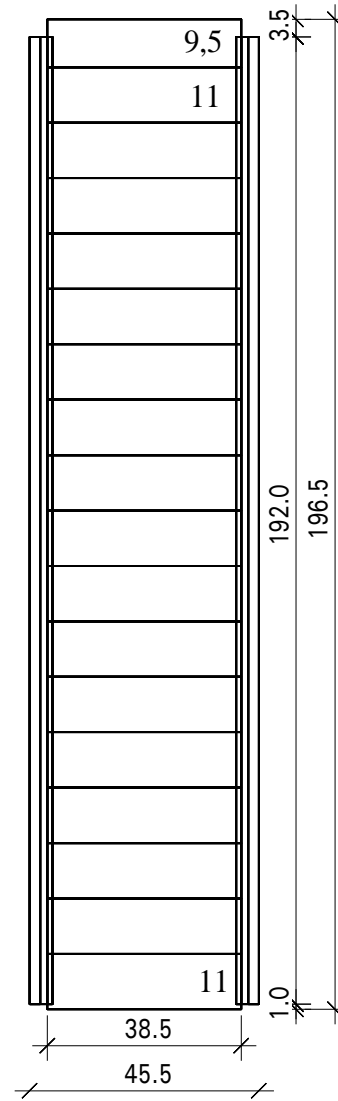
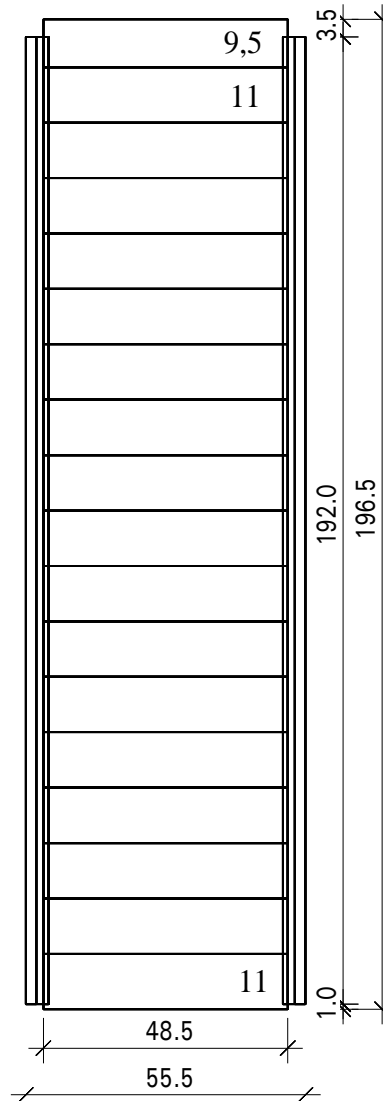
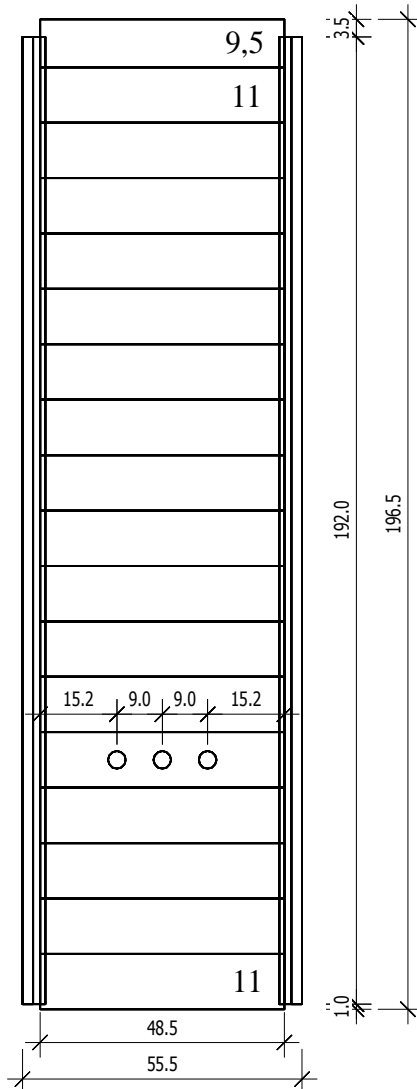
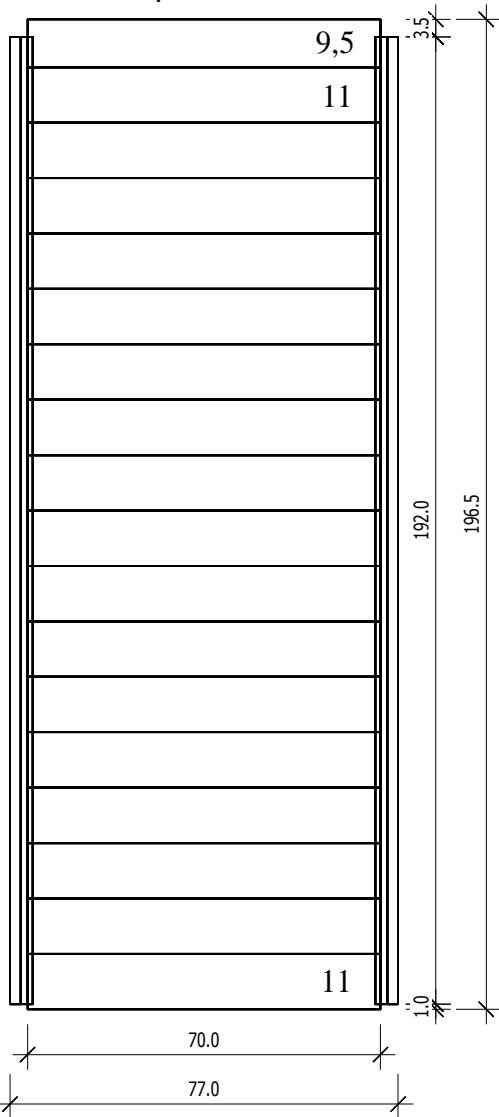

1 vnt.

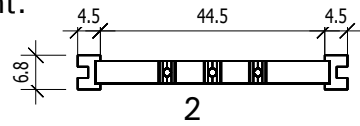

1 vnt.

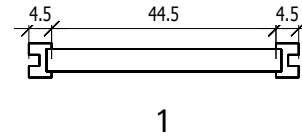

1 vnt.

3

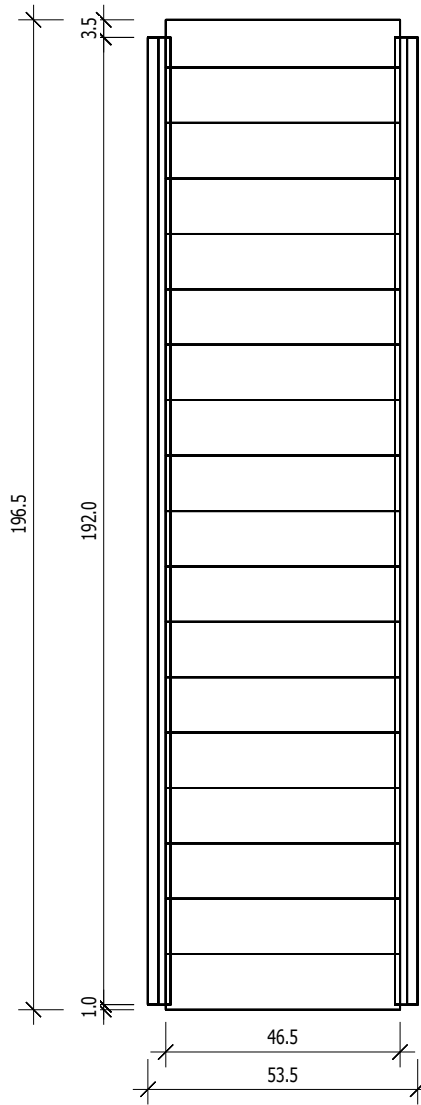
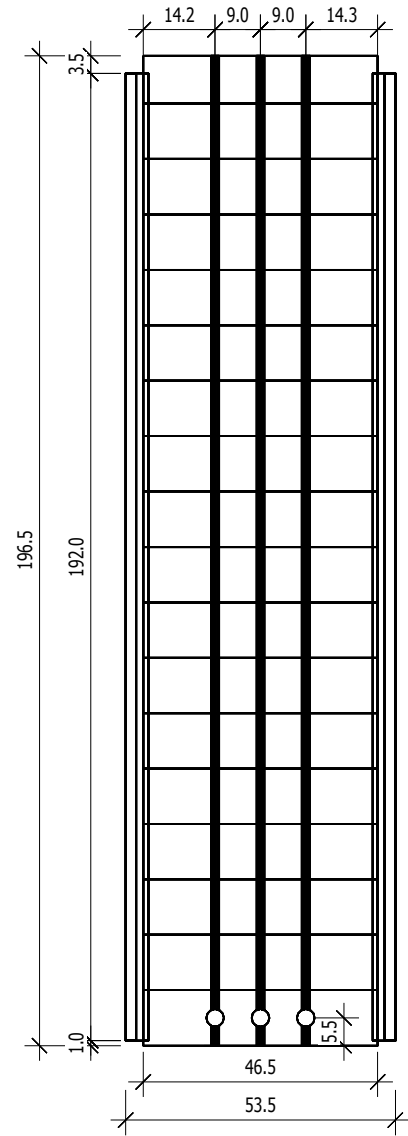
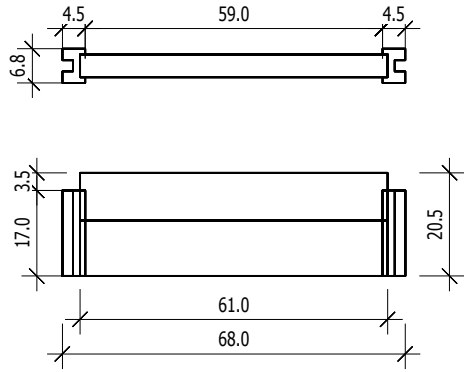

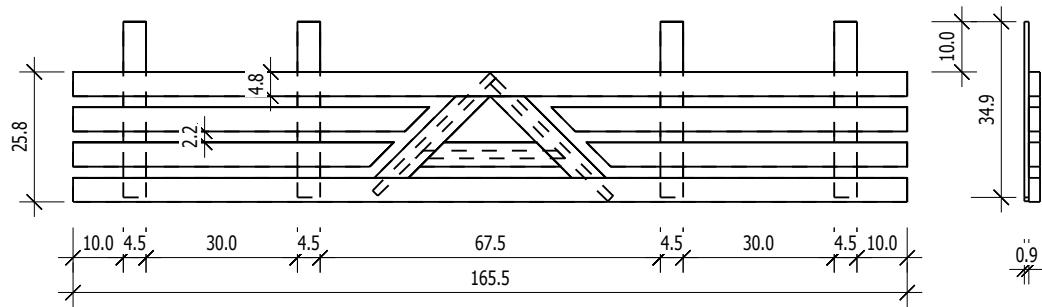
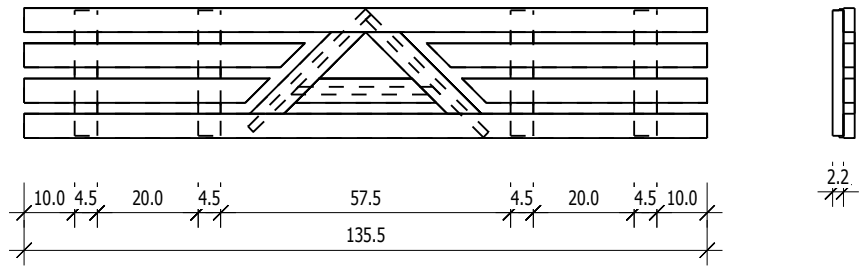
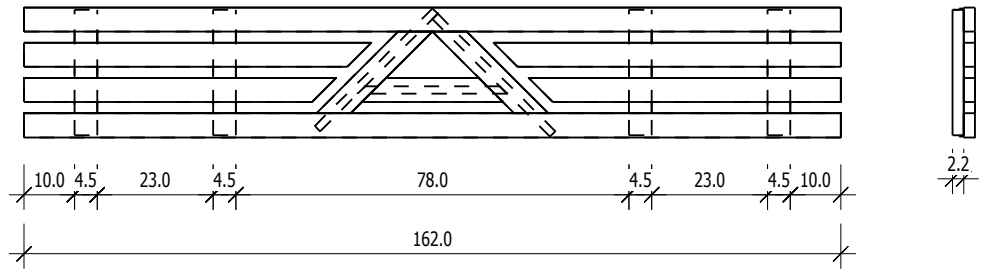

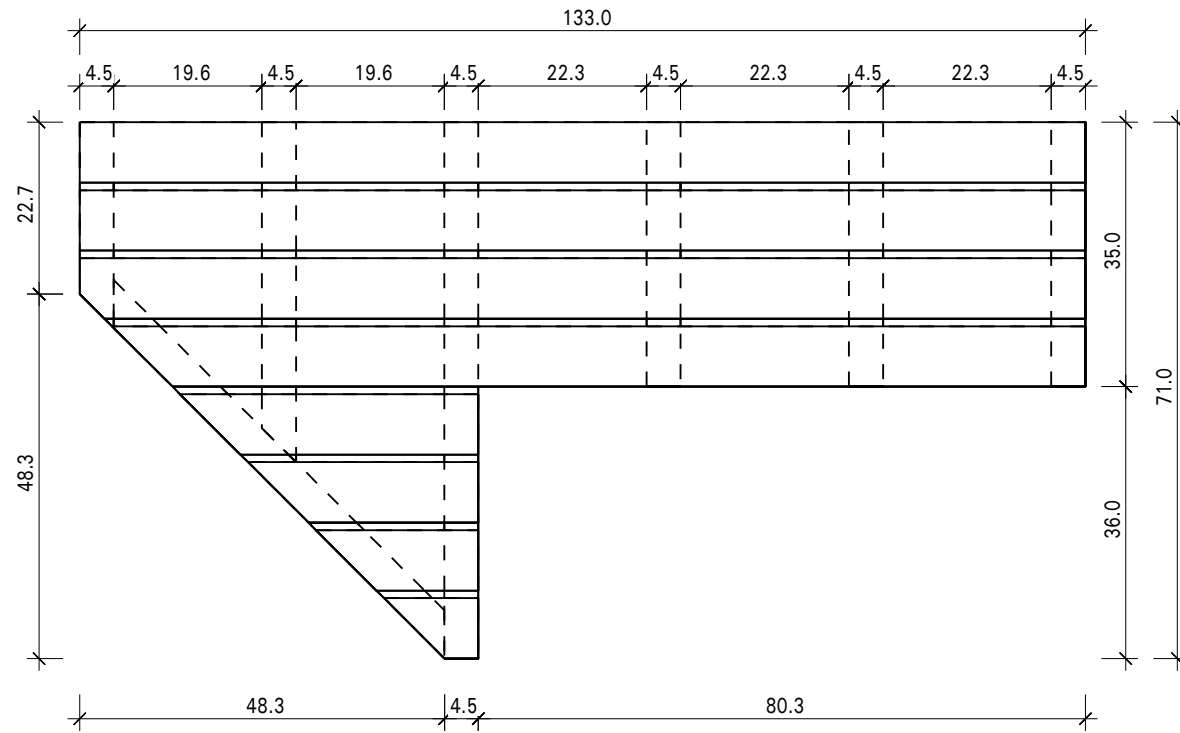

2 vnt.

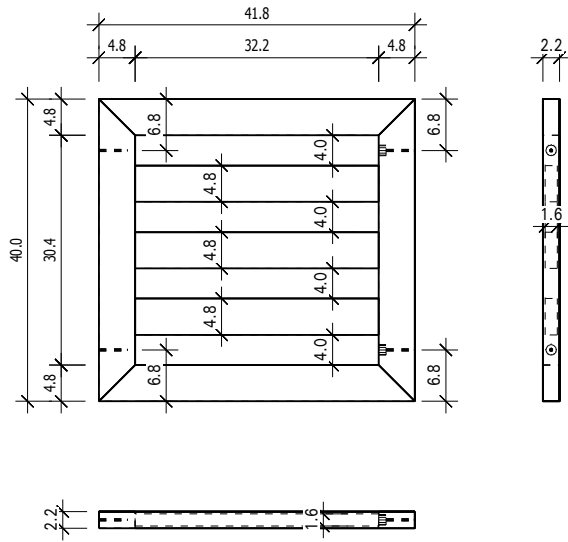

1 vnt.

