

***52-02-22AZ Lugano cabin
400x300cm***

-

| | | | | |
|--------------------|---|--|-----------|------------------------|
| Project Nr. | | 52-02-22AZ Lugano cabin 400x300cm | | |
| Dealer | - | COVER PAGE | | Scale |
| Dealers references | - | | | Date |
| | - | Drawer | Sheet Nr. | |
| | - | RB | TD | 09.02.2022 11:42:59 |

Wall logs

| Log thickness | Log height | Cut Length | Count |
|---------------|------------|------------|-------|
| 28 mm | 135 mm | 1224 | 30 |
| 28 mm | 135 mm | 3798 | 2 |

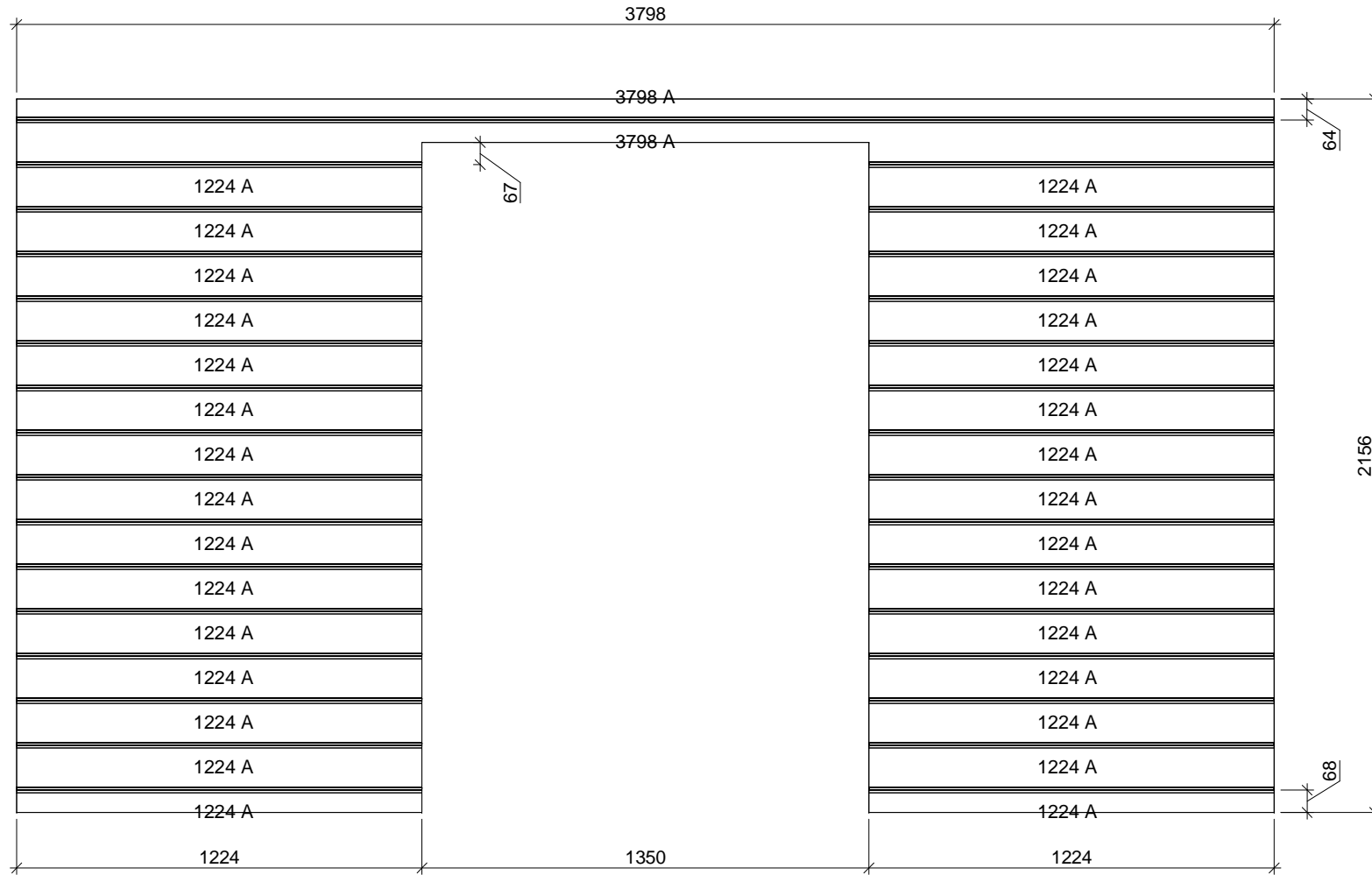

| | | | |
|--|---|------------------------|-----------|
| Project Nr. | | | |
| 52-02-22AZ Lugano cabin 400x300cm | | | |
| Dealer | - | Scale | |
| Dealers references | - | Wall logs | |
| | - | Drawer | Sheet Nr. |
| | - | RB | WALL - A |
| | - | Date | |
| | - | 09.02.2022 11:42:56 | |

Wall logs

| Log thickness | Log height | Cut Length | Count |
|---------------|------------|------------|-------|
| 28 mm | 135 mm | 2798 | 17 |

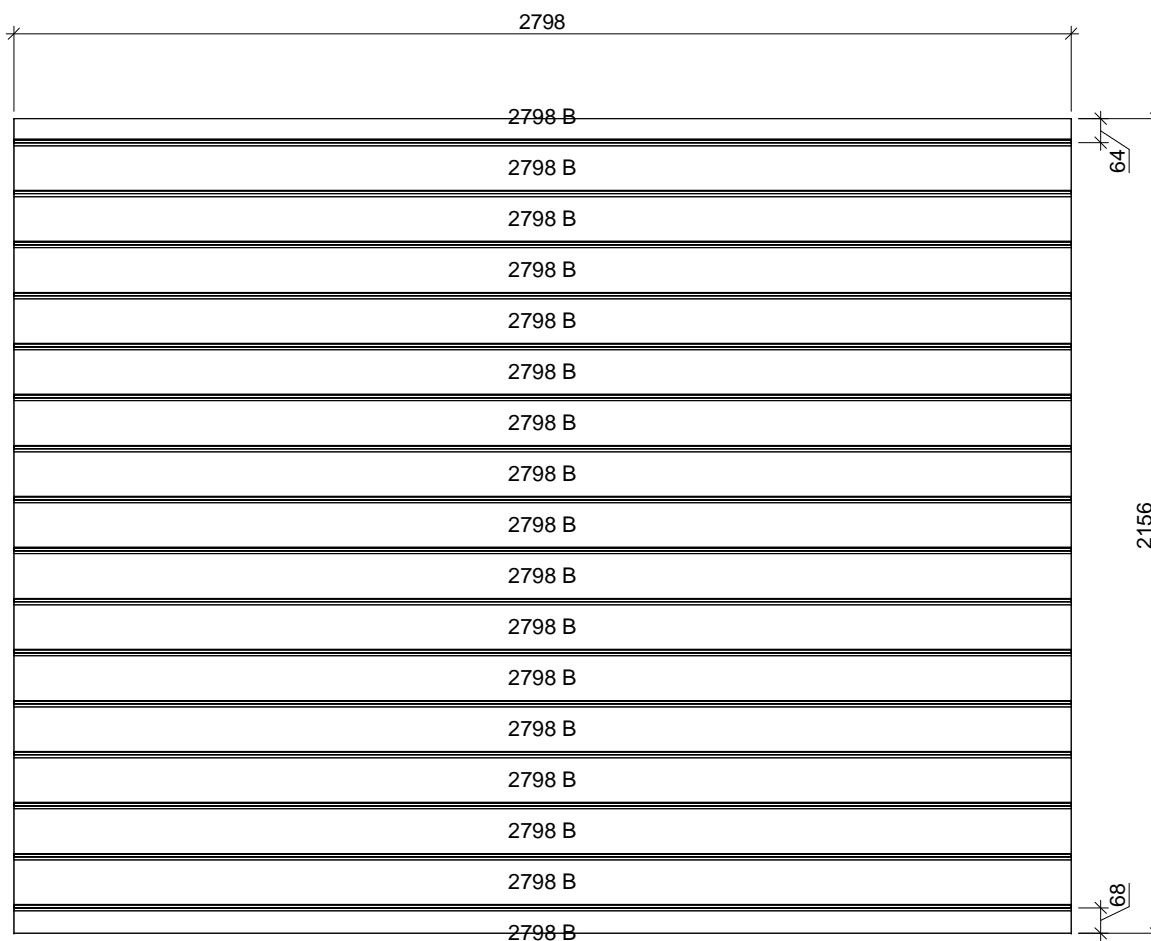

| | | | |
|--|---|-----------|------------------------|
| Project Nr. | | | |
| 52-02-22AZ Lugano cabin 400x300cm | | | |
| Dealer | - | Wall logs | Scale |
| Dealers references | - | | 1 : 20 |
| | - | Drawer | Sheet Nr. |
| | - | RB | WALL - B |
| | - | | Date |
| | - | | 09.02.2022 11:42:56 |

Wall logs

| Log thickness | Log height | Cut Length | Count |
|---------------|------------|------------|-------|
| 28 mm | 135 mm | 1858 | 17 |

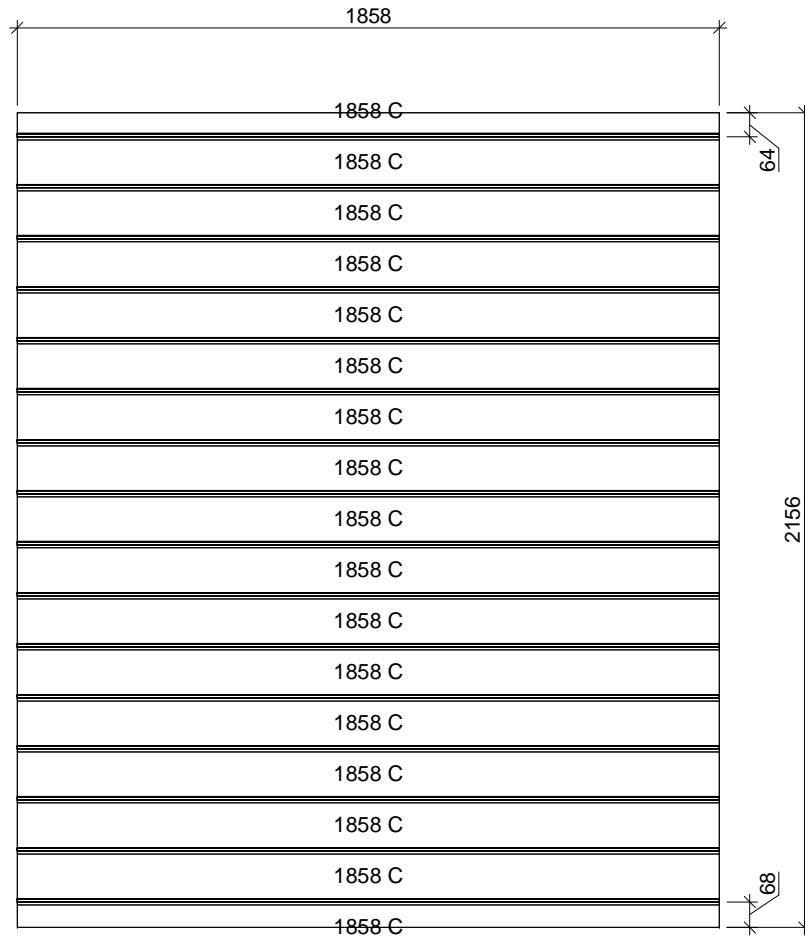

| | | | | |
|--|---|-----------|-----------|------------------------|
| Project Nr. | | | | |
| 52-02-22AZ Lugano cabin 400x300cm | | | | |
| Dealer | - | Wall logs | | Scale |
| | | | | 1 : 20 |
| Dealers references | - | Drawer | Sheet Nr. | Date |
| | - | RB | WALL - C | 09.02.2022 11:42:57 |

Wall logs

| Log thickness | Log height | Cut Length | Count |
|---------------|------------|------------|-------|
| 28 mm | 135 mm | 1858 | 17 |

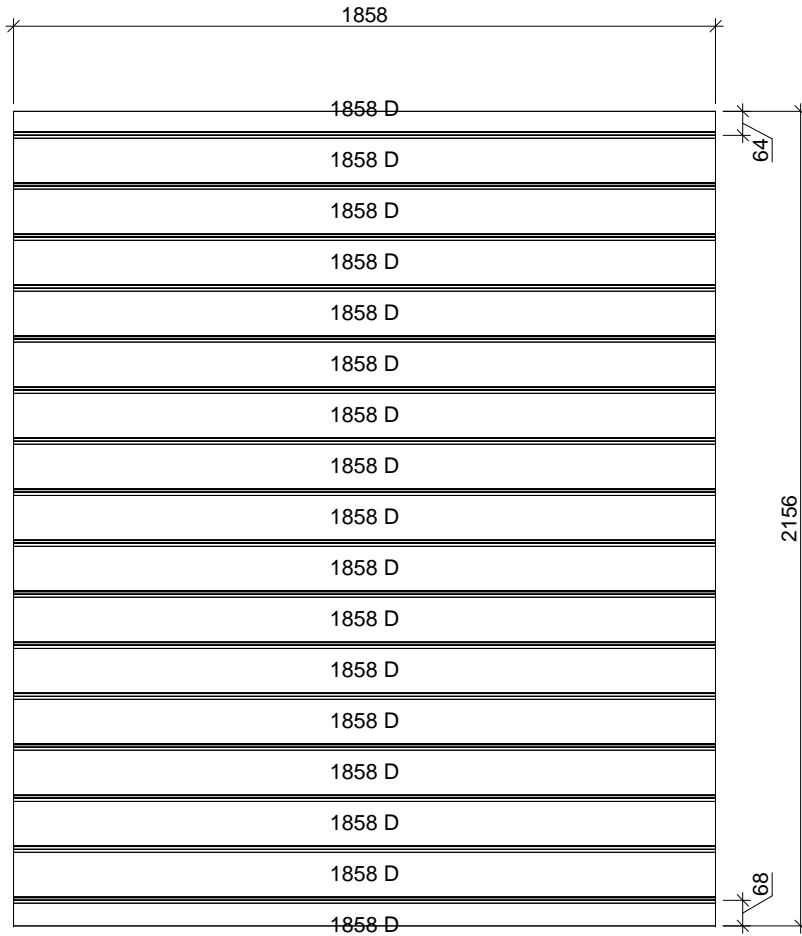

| | | | |
|--|---|-----------|------------------------|
| Project Nr. | | | |
| 52-02-22AZ Lugano cabin 400x300cm | | | |
| Dealer | - | Wall logs | |
| Dealers references | | | |
| | | Scale | 1 : 20 |
| | | Drawer | Sheet Nr. |
| | | RB | WALL - D |
| | | | Date |
| | | | 09.02.2022 11:42:57 |

Wall logs

| Log thickness | Log height | Cut Length | Count |
|---------------|------------|------------|-------|
| 28 mm | 135 mm | 2798 | 17 |

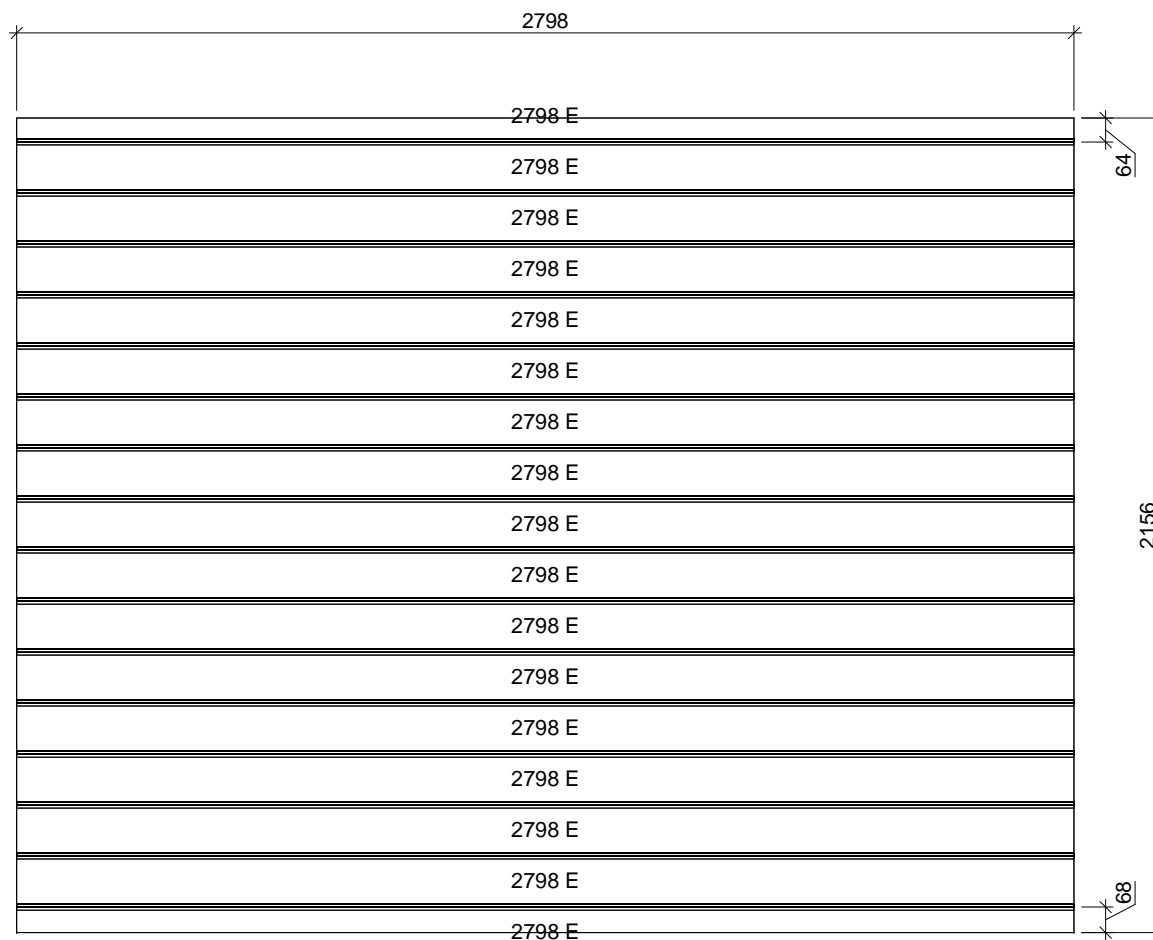

| | | | |
|--|---|-----------|------------------------|
| Project Nr. | | | |
| 52-02-22AZ Lugano cabin 400x300cm | | | |
| Dealer | - | Wall logs | |
| Dealers references | - | | |
| | - | Scale | 1 : 20 |
| | - | Drawer | Sheet Nr. |
| | - | RB | WALL - E |
| | - | Date | 09.02.2022 11:42:57 |

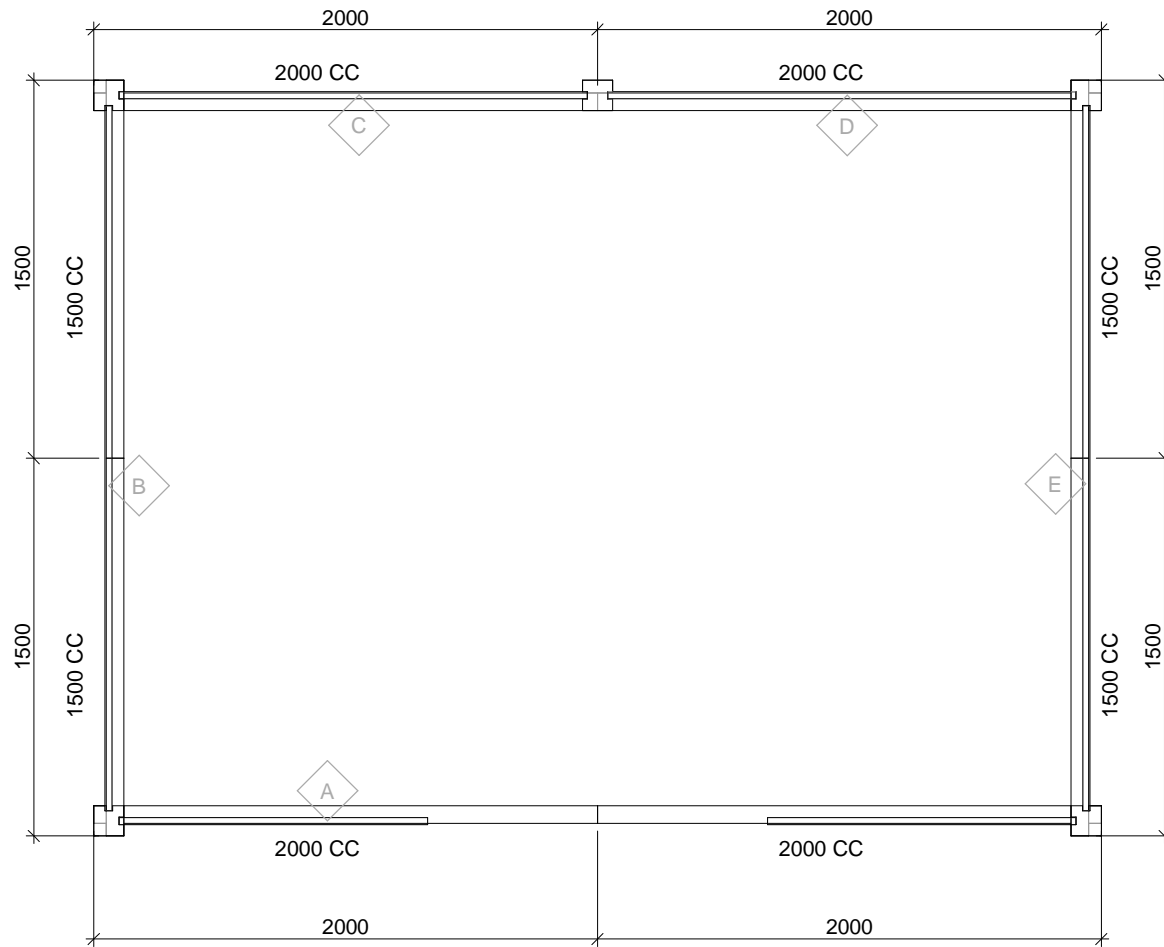

Base beam plan

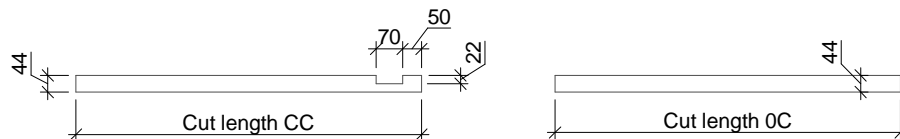

Base beam details



BASE BEAMS

| Image | Keynote | Description | Mark | Cut Length | Count | Volume |
|---|----------|-----------------|------|------------|-------|----------------------|
|  | BB 44x70 | Base beam 44x70 | CC | 1500 | 4 | 0.018 m ³ |
|  | BB 44x70 | Base beam 44x70 | CC | 2000 | 4 | 0.024 m ³ |
| | | | | | | 0.042 m ³ |

Project Nr.

52-02-22AZ Lugano cabin 400x300cm

Dealer

BASE BEAMS

Scale

As indicated

Dealers references

Drawer

Sheet Nr.

Date

RB

TD-1

09.02.2022
11:42:59

Post and wall plate 3D view

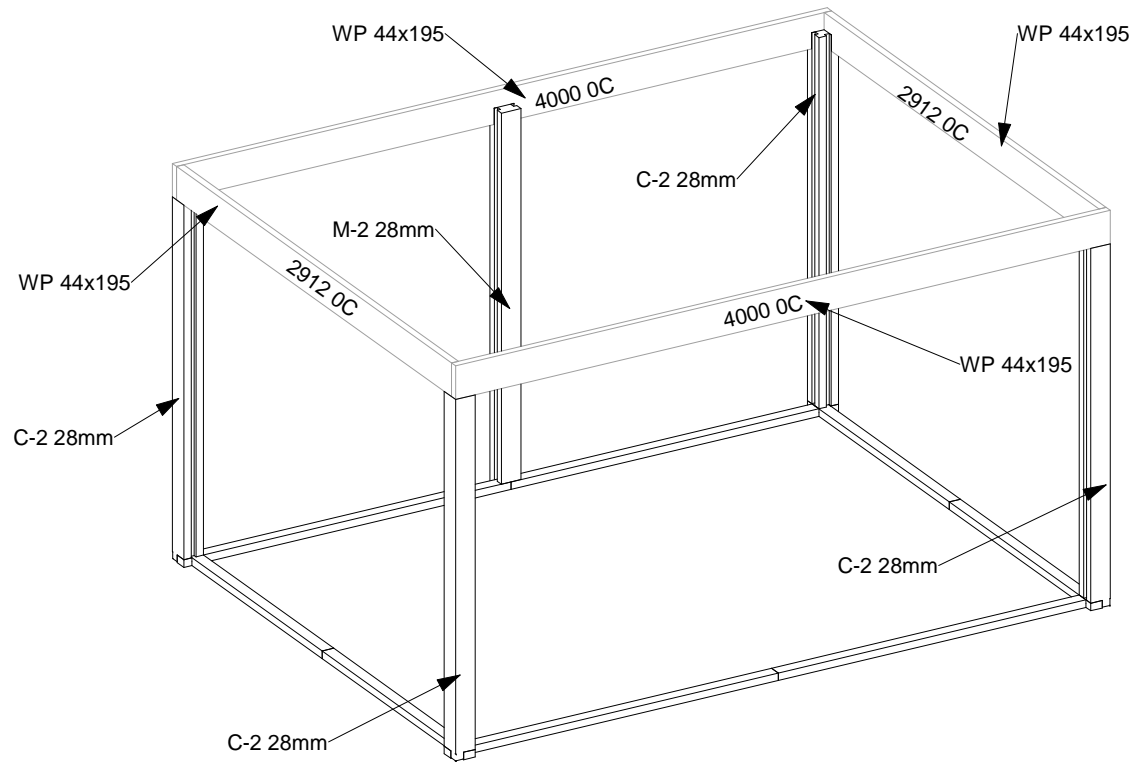

POST SCHEDULE

| Keynote | Description | Length | Count | Volume |
|----------|--------------|--------|-------|----------------------|
| C-2 28mm | Post 120x120 | 2195 | 4 | 0.111 m ³ |
| M-2 28mm | Post 120x120 | 2195 | 1 | 0.028 m ³ |
| | | | | 0.139 m ³ |

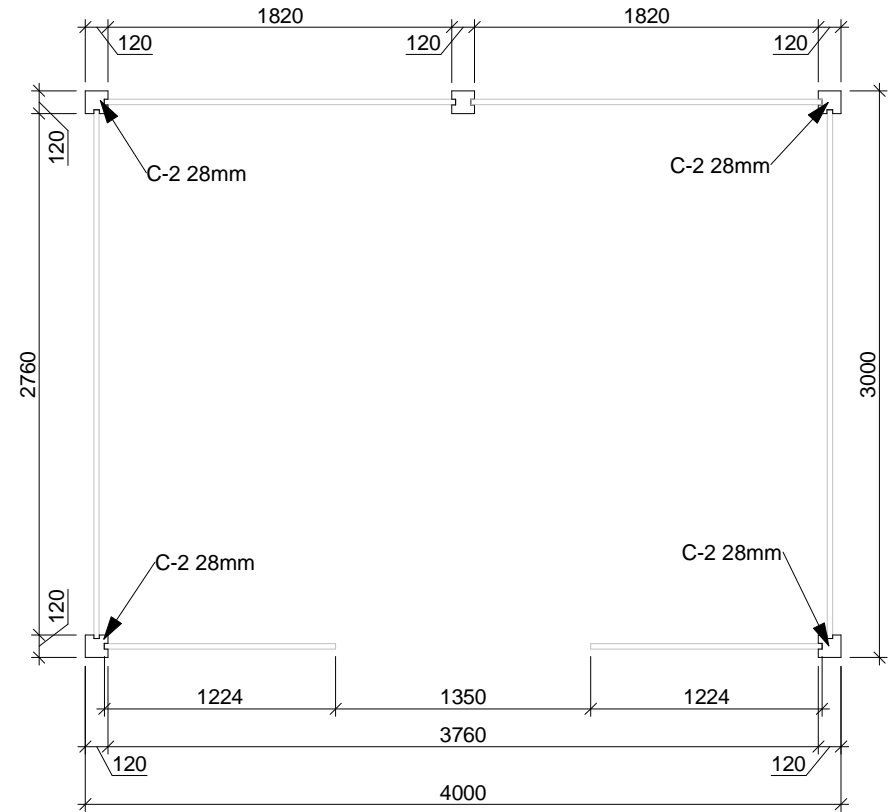

Front wall plate span is to big. No guarante to roof structure

Project Nr.

52-02-22AZ Lugano cabin 400x300cm

| Dealer | | POST SCHEDULE AND PLACEMENT | | Scale |
|--------------------|--|-----------------------------|-----------|------------------------|
| - | | | | 1 : 40 |
| Dealers references | | Drawer | Sheet Nr. | Date |
| - | | RB | TD-2 | 09.02.2022 11:42:59 |

Wall plate plan view

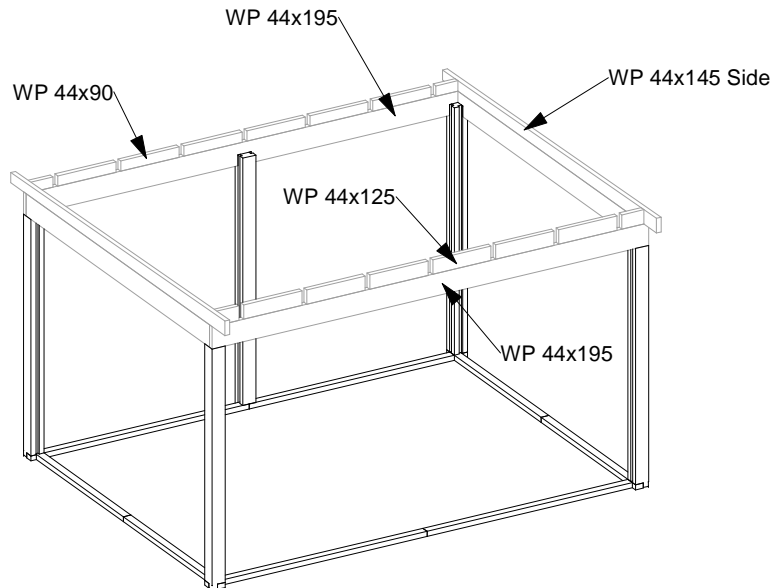
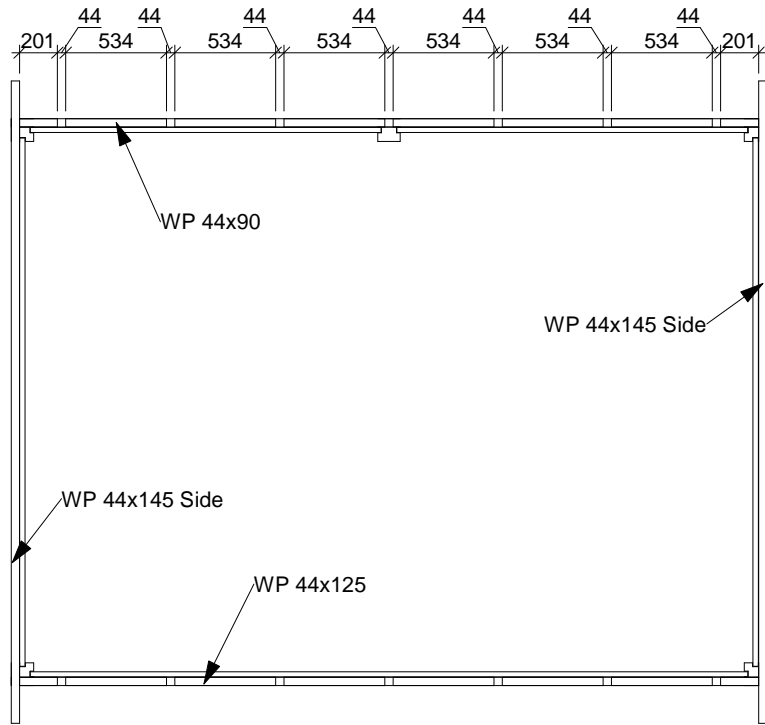

WALL PLATE

| Keynote | Description | Mark | Count | Cut Length |
|----------------|----------------|------|-------|------------|
| WP 44x90 | WP 44x90 | 0C | 2 | 201 |
| WP 44x90 | WP 44x90 | 0C | 6 | 534 |
| WP 44x125 | WP 44x125 | 0C | 2 | 201 |
| WP 44x125 | WP 44x125 | 0C | 6 | 534 |
| WP 44x145 Side | WP 44x145 Side | 0C | 2 | 3400 |
| WP 44x195 | Wp 44x195 | 0C | 2 | 2912 |
| WP 44x195 | Wp 44x195 | 0C | 2 | 4000 |

Wall plate detail view

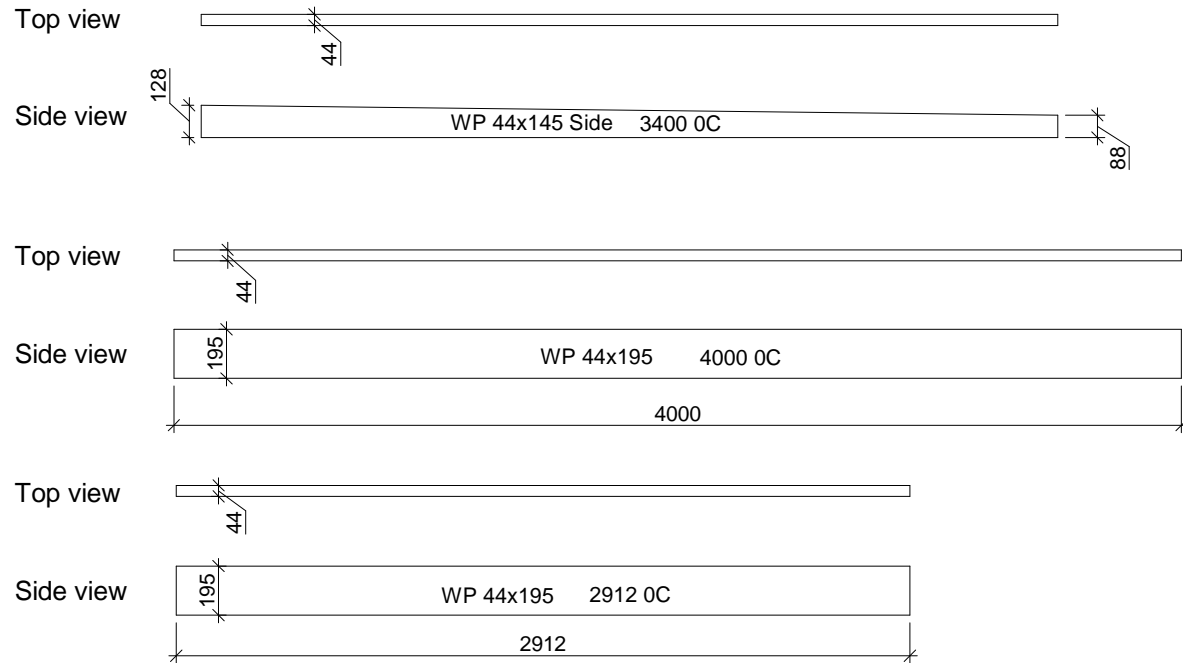

| | | | |
|--|---|------------------------|--------------|
| Project Nr. | | | |
| 52-02-22AZ Lugano cabin 400x300cm | | | |
| Dealer | WALL PLATE DETAIL VIEWS AND SCHEDULE | | Scale |
| - | | | As indicated |
| Dealers references | - | Drawer | Sheet Nr. |
| - | - | RB | TD-3 |
| - | - | Date | |
| - | - | 09.02.2022 11:42:59 | |

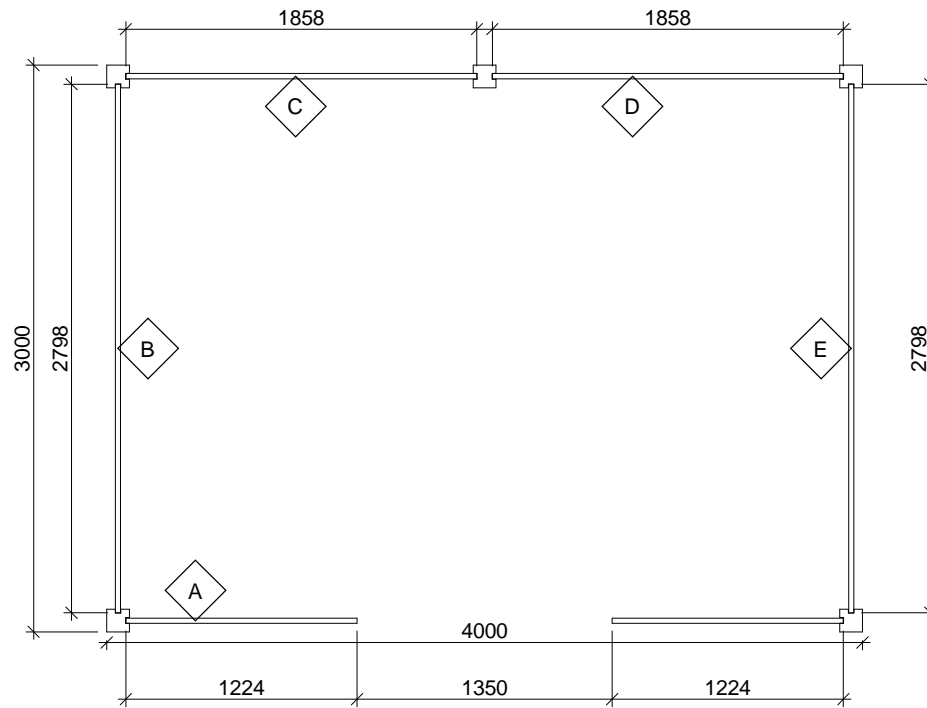

Wall log specification

| Keynote | Wall | Log height | Cut Length | Count | Volume |
|----------|------|------------|------------|-------|----------------------|
| LOG 28mm | A | 135 mm | 1224 | 30 | 0.130 m ³ |
| LOG 28mm | A | 135 mm | 3798 | 2 | 0.018 m ³ |
| LOG 28mm | B | 135 mm | 2798 | 17 | 0.164 m ³ |
| LOG 28mm | C | 135 mm | 1858 | 17 | 0.109 m ³ |
| LOG 28mm | D | 135 mm | 1858 | 17 | 0.109 m ³ |
| LOG 28mm | E | 135 mm | 2798 | 17 | 0.164 m ³ |

0.694 m³

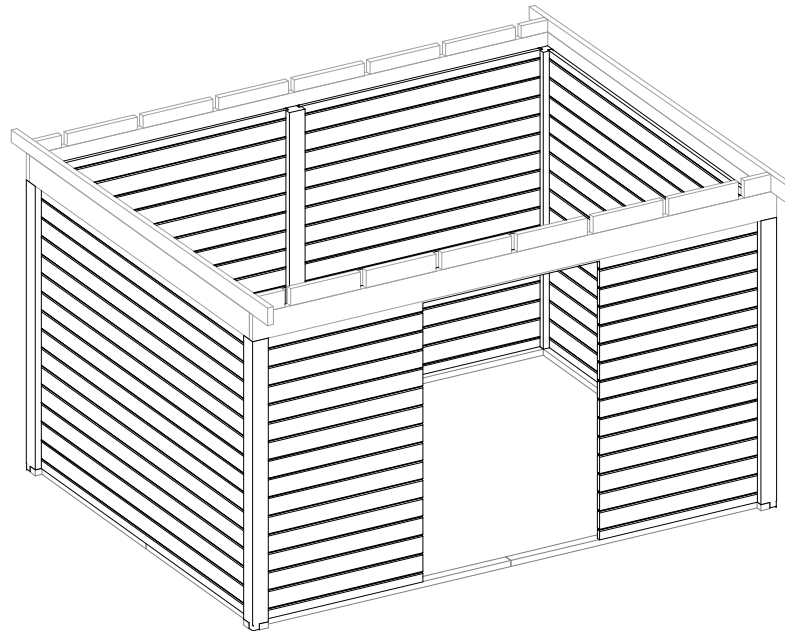

Project Nr.

52-02-22AZ Lugano cabin 400x300cm

Dealer

WALL PART FULL
SCHEDULE

Scale

1 : 40

Dealers
references

Drawer

Sheet Nr.

Date

RB

TD-4

09.02.2022
11:43:00

ROOF PARTS PLAN

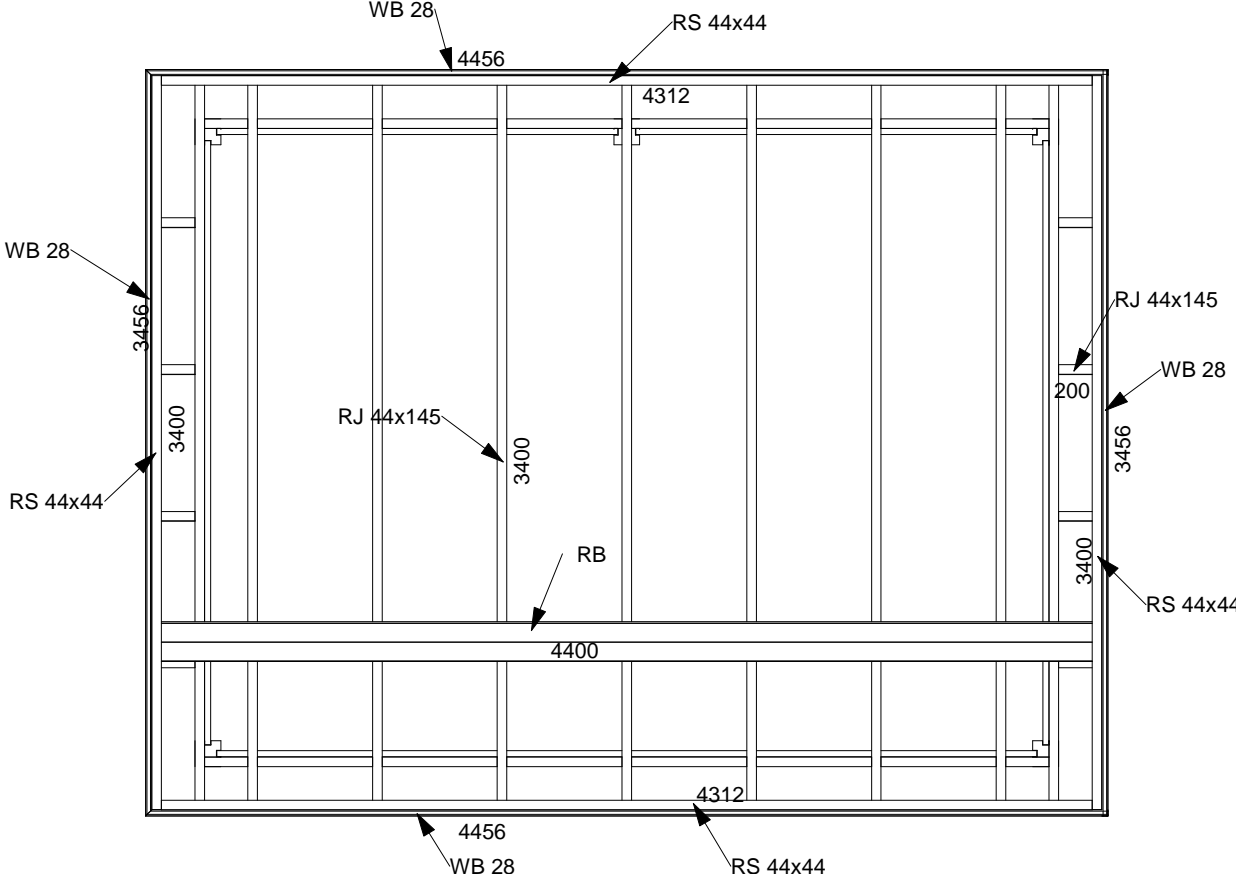

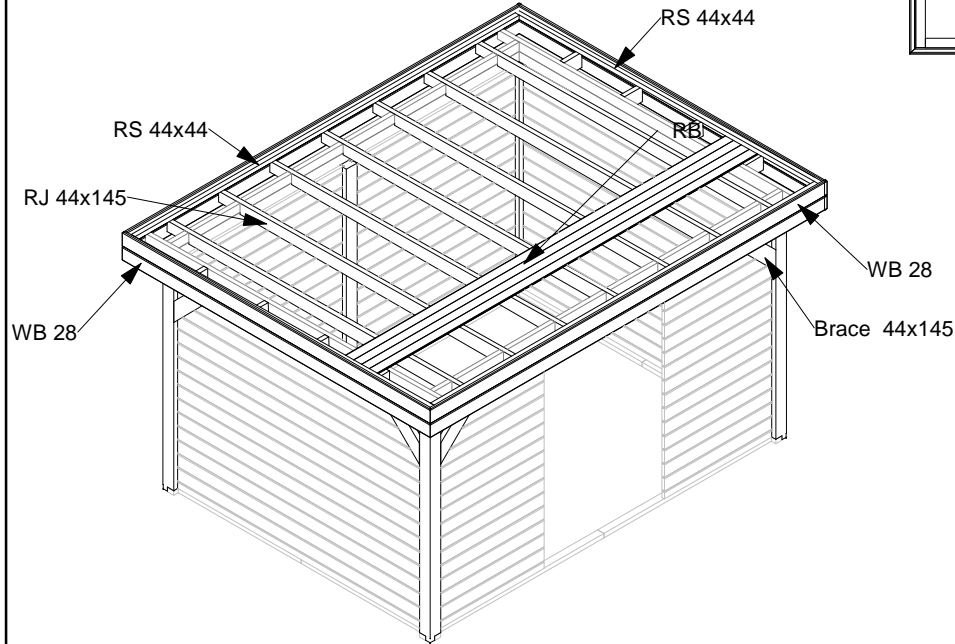

ROOF PARTS ASSEMBLY VIEW



| | | | |
|--|---|-------------------|------------------------|
| Project Nr. | | | |
| 52-02-22AZ Lugano cabin 400x300cm | | | |
| Dealer | - | ROOF PARTS | |
| Dealers references | - | | |
| | - | Scale | 1 : 35 |
| | - | Drawer | Sheet Nr. |
| | - | RB | TD-5 |
| | - | Date | 09.02.2022 11:43:00 |

ROOF BOARDS

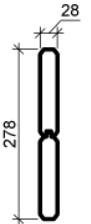
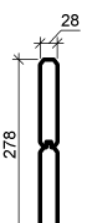
| Type Image | Keynote | Description | Count | Cut Length | Volume |
|--|-------------|--------------------------|-------|------------|----------------------|
|  | RB | Roof board 18mm | 39 | 4400 | 0.268 m ³ |
|  | RS 44x44 | Roof side board 44x44 | 2 | 3400 | 0.013 m ³ |
|  | RS 44x44 | Roof side board 44x44 | 2 | 4312 | 0.017 m ³ |
|  | WB 28 | Wind board 28mm | 2 | 3456 | 0.052 m ³ |
|  | WB 28 | Wind board 28mm | 2 | 4456 | 0.067 m ³ |
| 0.417 m³ | | | | | |

Notes:

- All wind boards are provided longer, for precise cut on site.

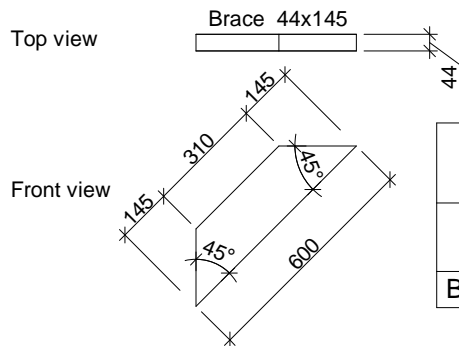

BRACE SCHEDULE

| Keynote | Description | Count | Cut Length | Volume |
|--------------|--------------|-------|------------|----------------------------|
| Brace 44x145 | Brace 44x145 | 8 | 600 | 0.023 m ³ |
| | | | | 0.023 m³ |

SCREW AND FIXING SCHEDULE

| Keynote | Length | Description | Count | Model |
|---------|--------|-------------|-------|-------------------------------|
| 3.5x45 | 45 | Screw | 468 | Roof board screws |
| 5x100 | 100 | Screw | 36 | 0,5 log screws |
| 5x100 | 100 | Screw | 2 | Post connection to base beam |
| 5x100 | 100 | Screw | 20 | Post connection to wall plate |
| 5x100 | 100 | Screw | 56 | Top log screws |
| 5x120 | 120 | Screw | 16 | Brace screws |
| 5x120 | 120 | Screw | 4 | Post connection to base beam |
| 5x120 | 120 | Screw | 80 | Roof joist screws |
| 6x200 | 200 | Screw | 14 | Roof joist screws |

Roof joist detail views

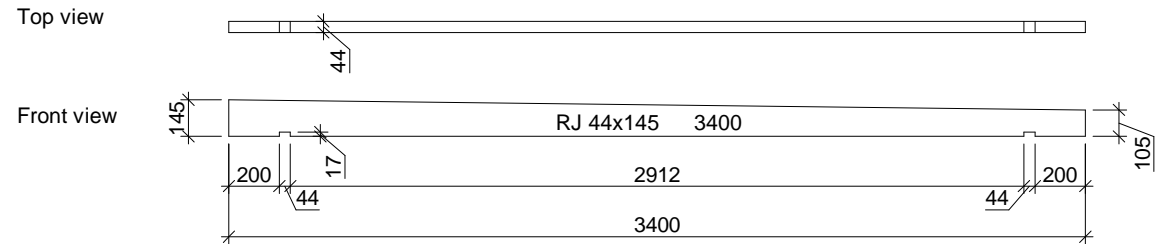

ROOF JOIST SCHEDULE

| Keynote | Description | Count | Cut Length | Volume |
|-----------|-------------------|-------|------------|----------------------------|
| RJ 44x145 | Roof joist 44x145 | 8 | 200 | 0.010 m ³ |
| RJ 44x145 | Roof joist 44x145 | 7 | 3400 | 0.130 m ³ |
| | | | | 0.141 m³ |

Project Nr.

52-02-22AZ Lugano cabin 400x300cm

| Dealer | ROOF PARTS SCHEDULES | | Scale |
|--------------------|----------------------|-----------|------------------------|
| - | | | As indicated |
| Dealers references | Drawer | Sheet Nr. | Date |
| - | RB | TD-6 | 09.02.2022 11:43:01 |