

Fouronnes

19-140-0220-0/S9123+S9133

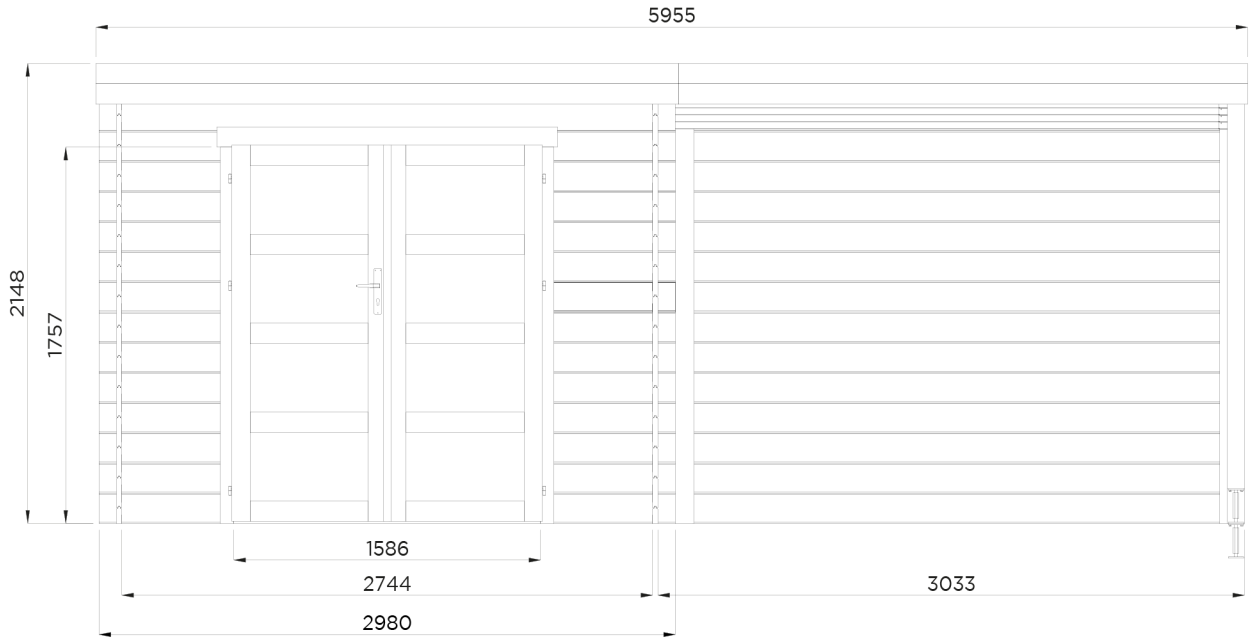

Fouronnes

19-140-0220-0/S9123+S9133

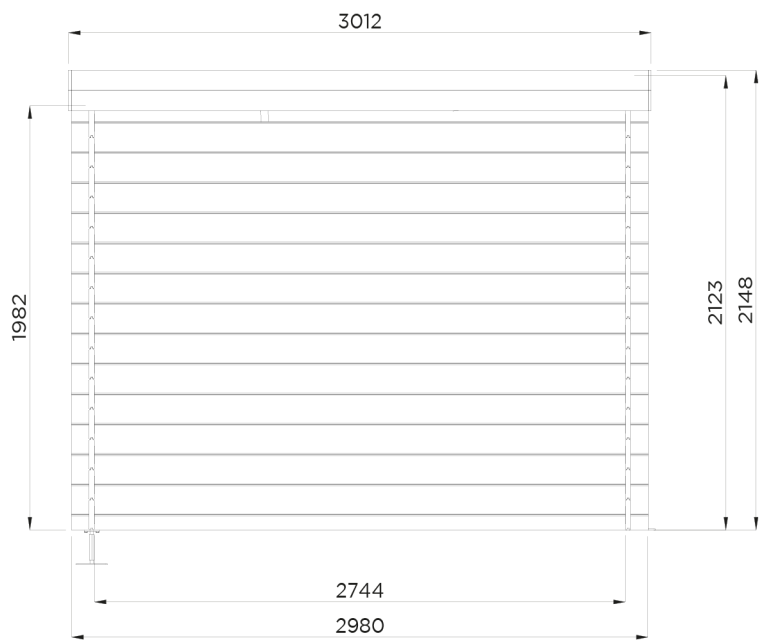

 7.53m²

 8.88m²

 17.94m²

Deuropening / Embrasure de porte / Doorway : 1586 x 1757

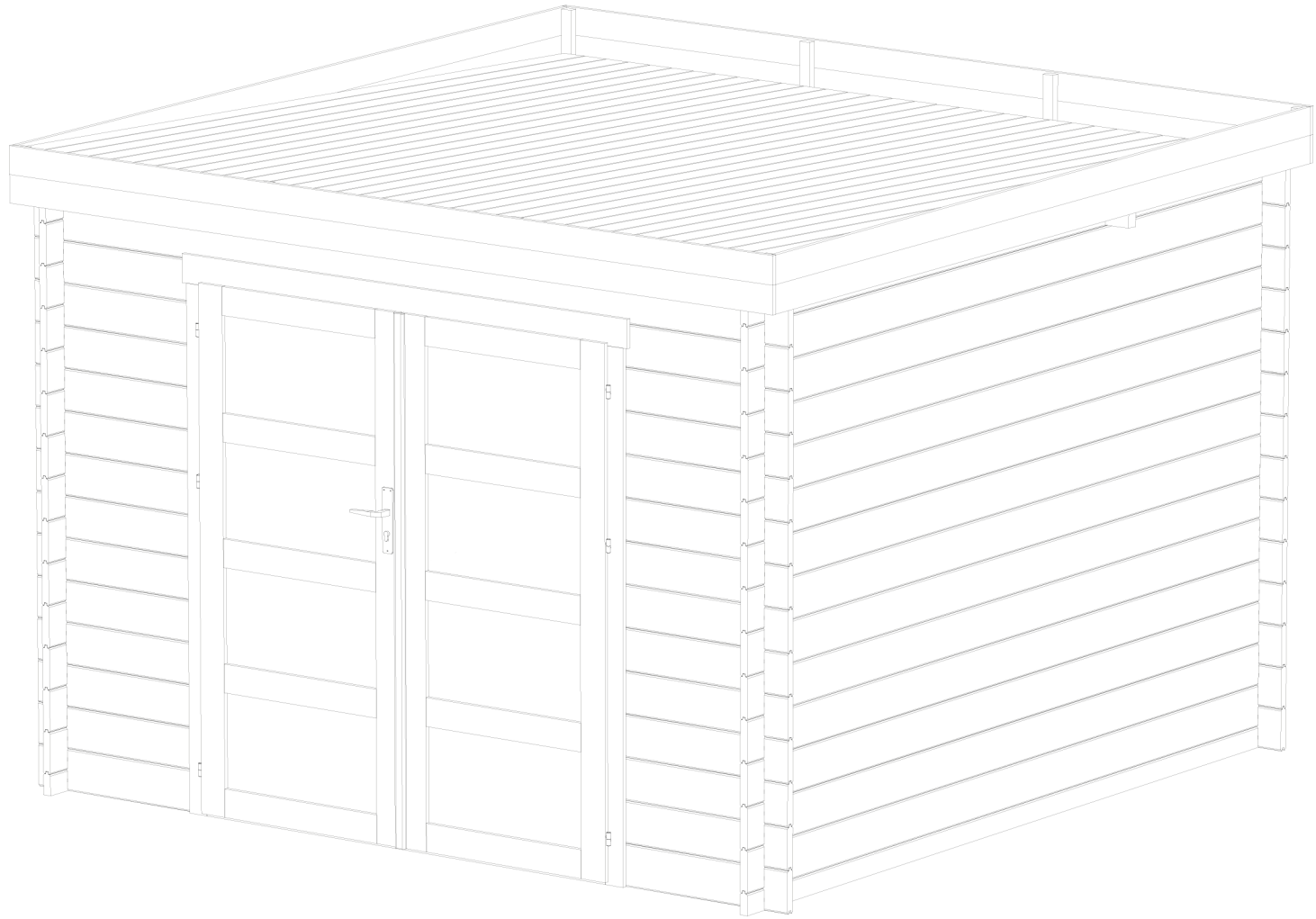

Ajaccio



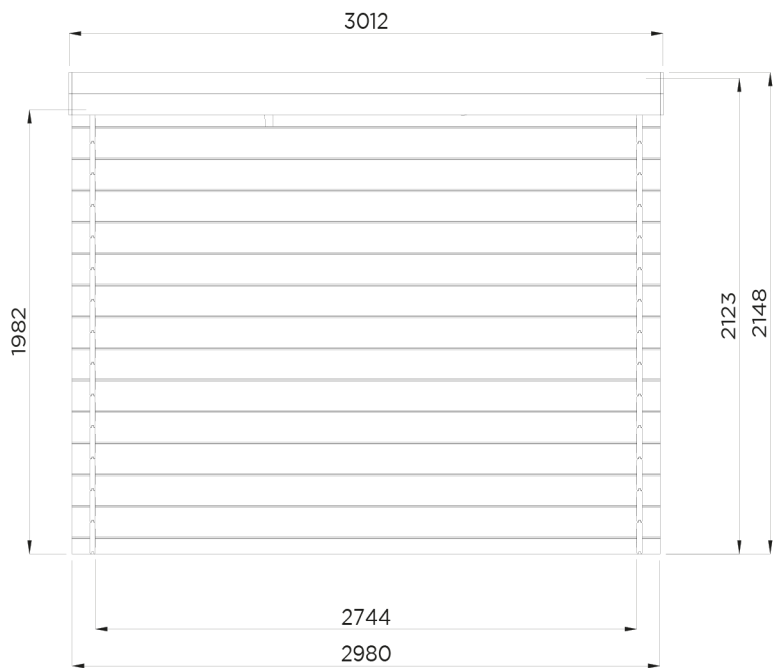
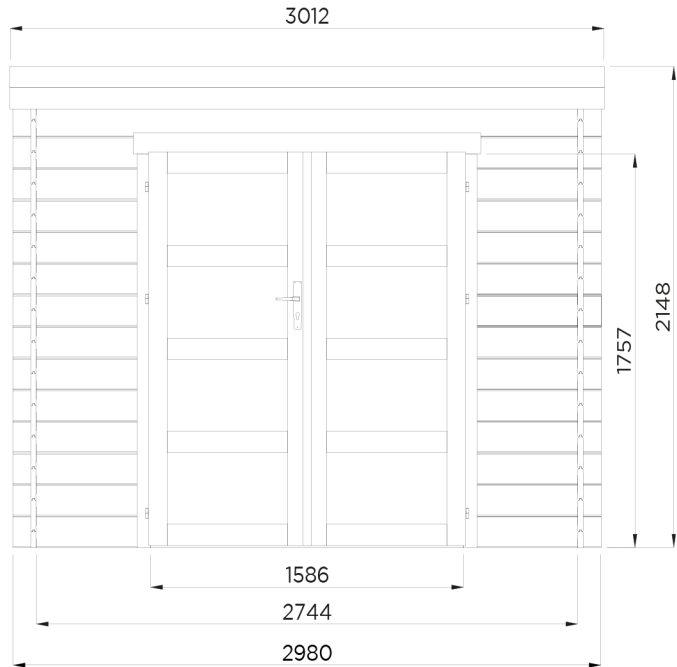



19-140-0096-0/S9123



Deuropening / Embrasure de porte / Doorway : 1586
x
1757

Stuklijst / Liste des pièces / Bill of material

1

	Ref.	Index	#
	A	WW028x149-STPP-IF1-O-2980	2
	B	WW028x149-S1IF-000-O-0650	26
	E	WW028x149-S2IF-000-O-2980	26
	G	WW028x149-S2IF-000-O-2980	16
	I	WW028x079-SDEM-000-O-2980	2
	J	WW016x095-PLA-000-O-2950	35

ALTERNATIEF :

Het kan productiematig zijn dat er andere planchettes J in de verpakking zitten.
De referentie is dan WW016x120-PLA-000-O-2950 => # 27 stuks

ALTERNATIVE :

Il peut être lié à la production que d'autres planchettes J soient incluses dans l'emballage.
La référence est alors WW016x120-PLA-000-O-2950 => # 27 pièces





ALTERNATIVE :









It may be production-related that other planchettes J are included in the package.
The reference is then WW016x120-PLA-000-O-2950 => # 27 pieces

ALTERNATIVE :

Es kann produktionsbedingt sein, dass andere Planchetten J im Paket enthalten sind.
Die Referenz ist dann WW016x120-PLA-000-O-2950 => # 27 Stück

	K	WW040x120-PT0-000-O-2980	2
	M	WW016x095-4FA-000-O-3100	8
	M1	WW028x040-4FA-000-O-1750	1



P	S8047C28	1
<ul style="list-style-type: none"> 1 x S8047  1 x S8094-K28  1 x WW012x040-2R8-000-O-1757  1 x RW020x060-4FA-000-O-1586  1 x S618  8 x S5245 (glass 345mm x 630mm)  1 x S646  + 6 x S6201  1 x S673  		



R	S637	2
 2.8 x 50 #100		



R1	S617	2
 3.5 x 35 #20		

PRINCIPE TPP

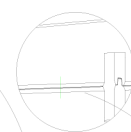
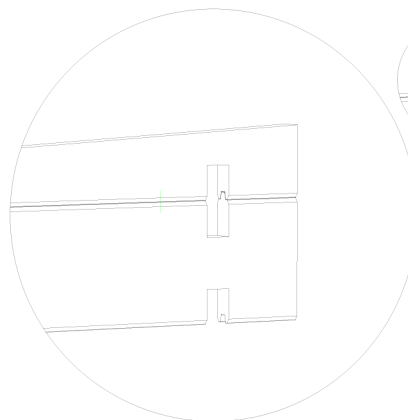
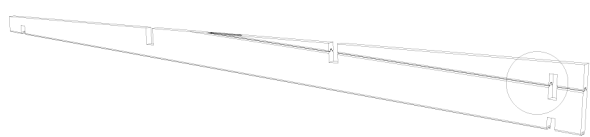

S9123

- A = 2
- B = 26
- E = 26
- G = 16
- I = 2
- K = 2

 2.8 x 50 # 12

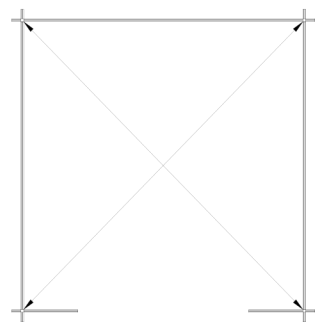
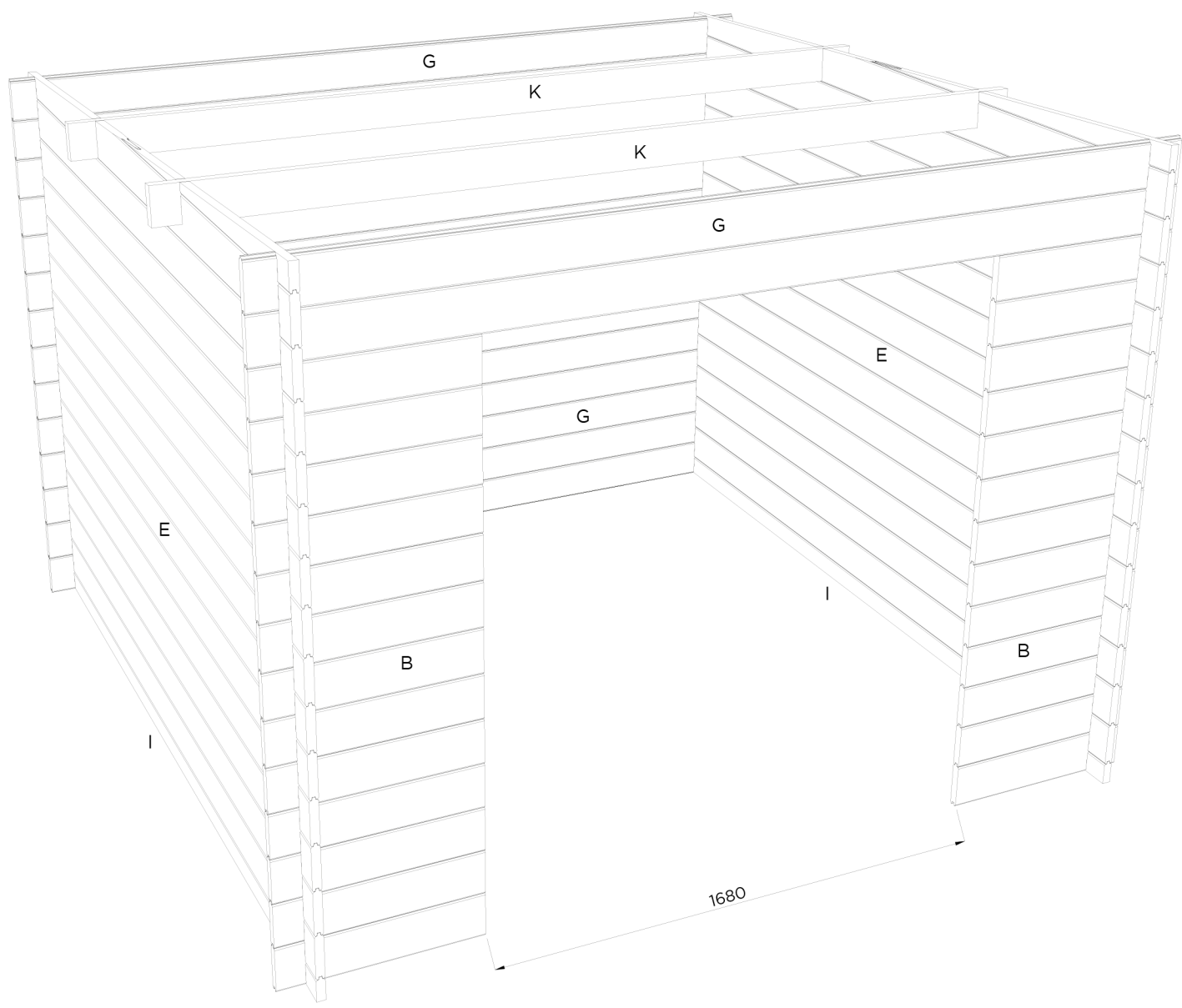

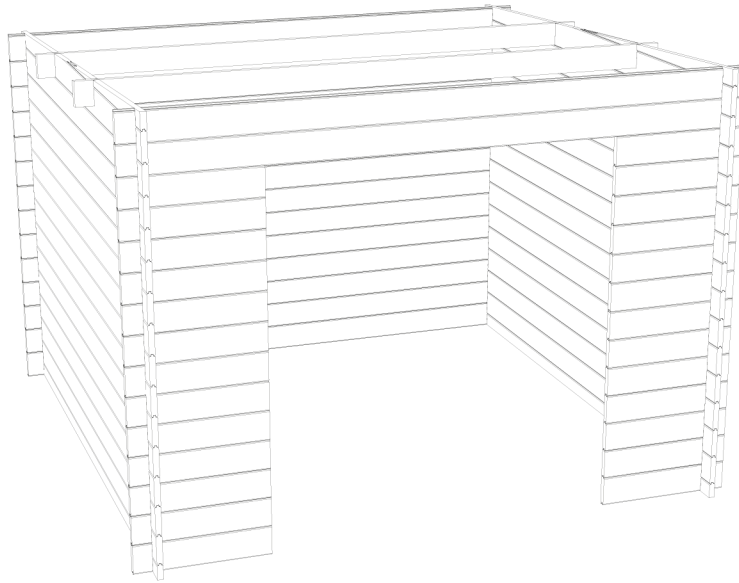

(NL) INFORMATIE :

Het is niet abnormaal dat kleine openingen te zien zijn bij de montage, zowel boven de deur als bij de dakopbouw. Deze zullen na het natuurlijk drogen van het product verdwijnen, hou er evenwel rekening mee dat dit enkele weken kan duren.

(FR) INFORMATION :

Il n'est pas anormal qu'il y ait des ouvertures à voir lors du montage tant au-dessus de la porte et les fenêtres qu'en montant le toit. Ceux-ci disparaîtront après le séchage naturel du produit. Tenez cependant compte que cela peut durer quelques semaines.

(GB) INFORMATION :

It is not unusual that small openings are visible during the assembly, both above the door and in the roof. These will disappear after the natural drying of the product, keep in mind, however, that this may take several weeks.

(D) INFORMATION :

Es ist nicht abnormal, dass beim Aufbau, sowohl oberhalb der Tür als auch beim Dachaufbau kleine Öffnungen zu sehen sind. Nach der natürlichen Trocknung des Produktes werden diese verschwinden. Berücksichtigen Sie aber, dass dies einige Wochen in Anspruch nehmen kann.

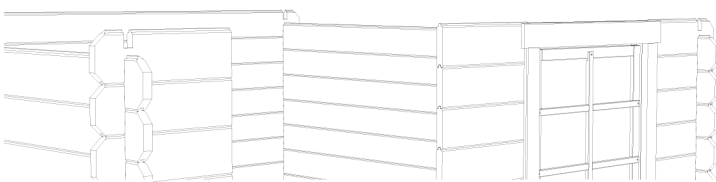
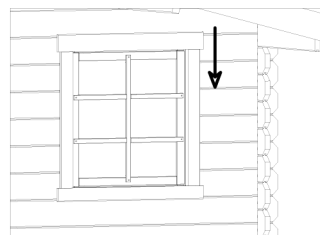
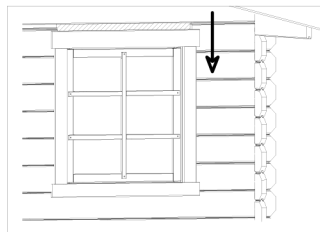
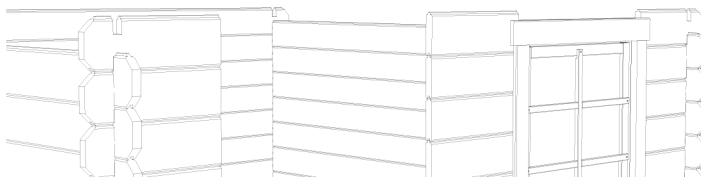

S9123

J = 35 of/ou/or/oder 27
2.8 x 50 # 140

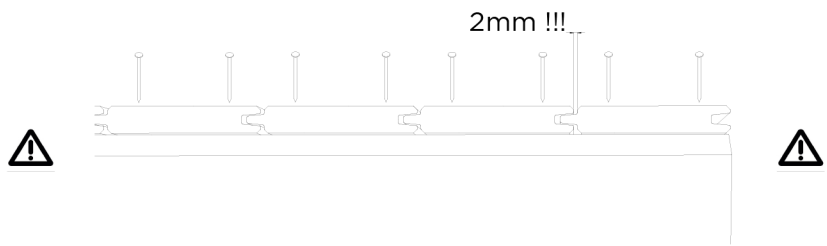
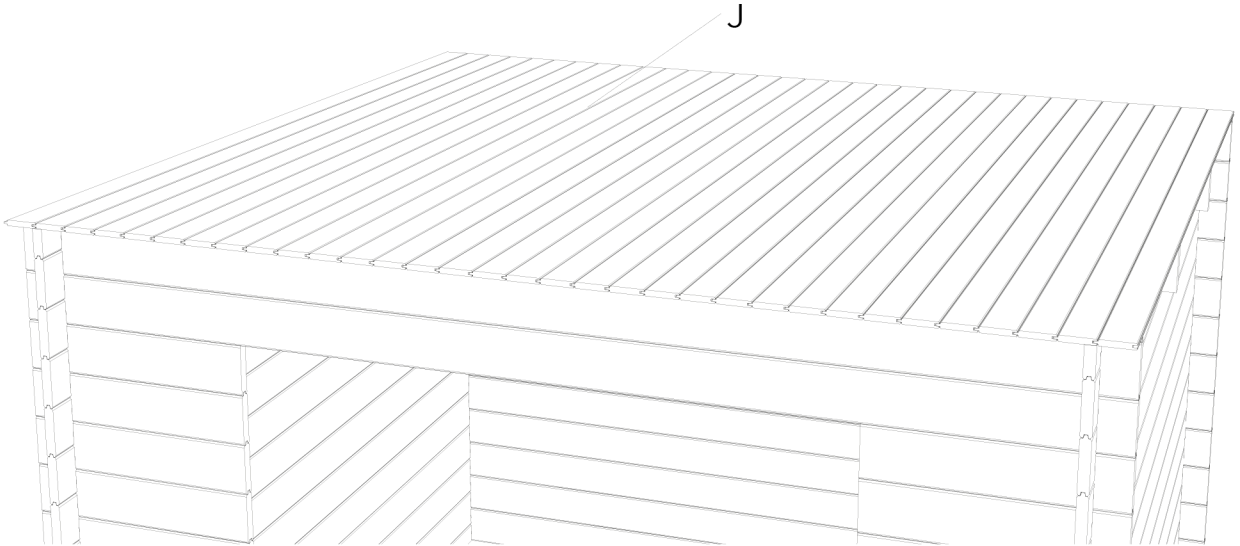

M = 8
M1 = 1
R1 = 24

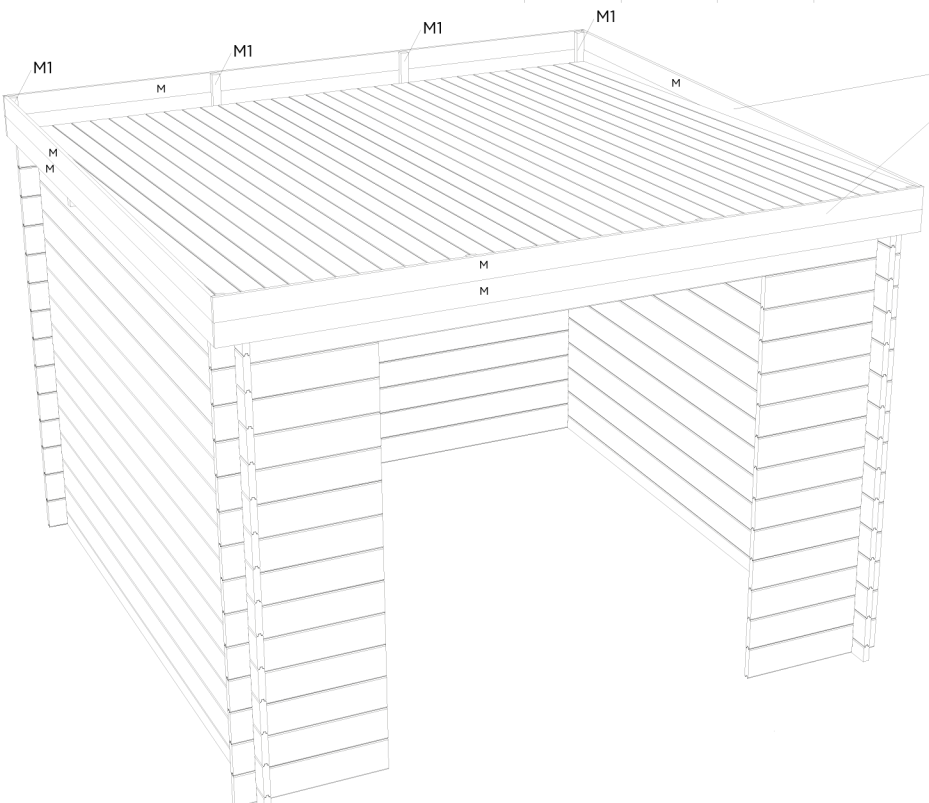

M
Af te korten in lengte !!!!
À raccourcir en longueur !!!!
To be shortened in length !!!!

S8047C28

1

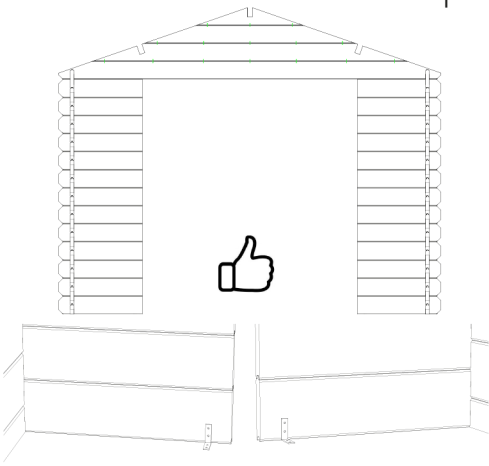

2

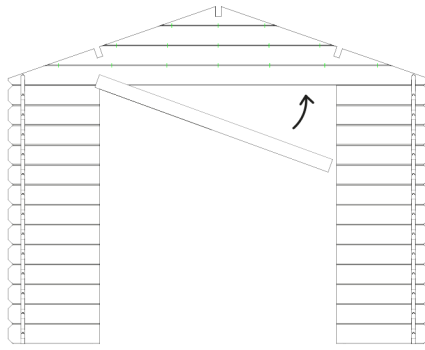

3

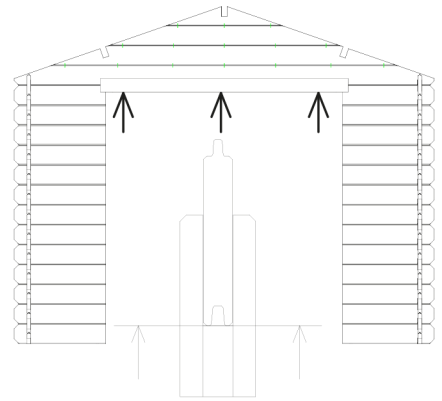

4

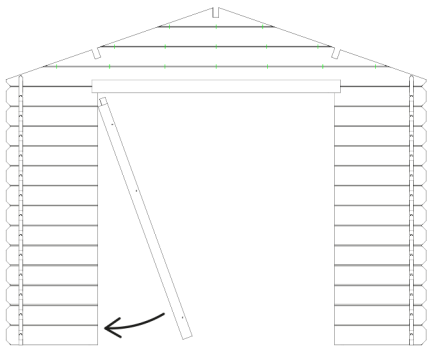

5

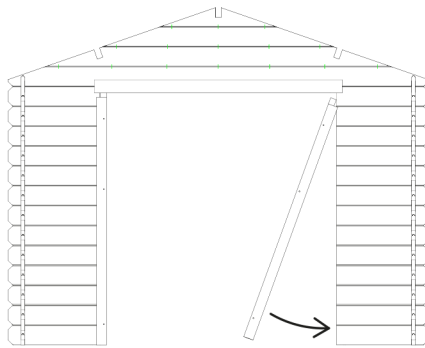

6

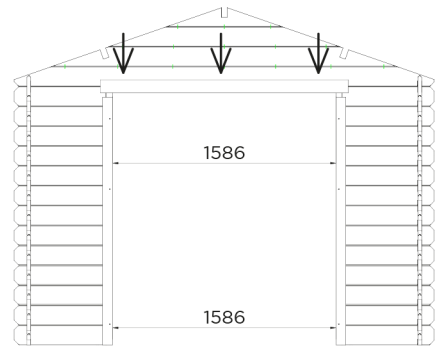

7

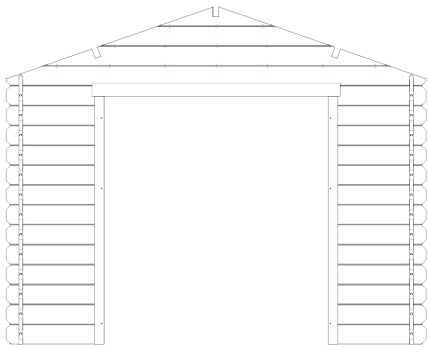

8

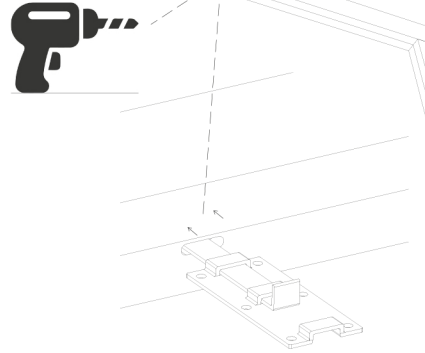

9

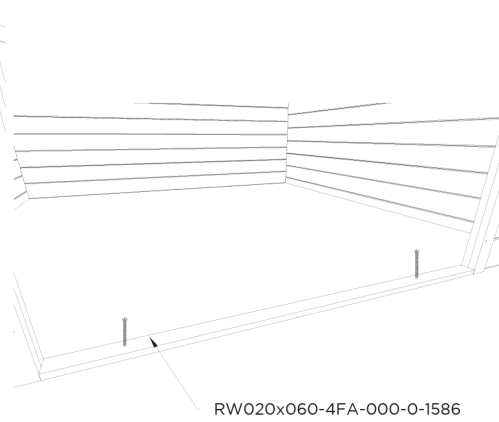

10

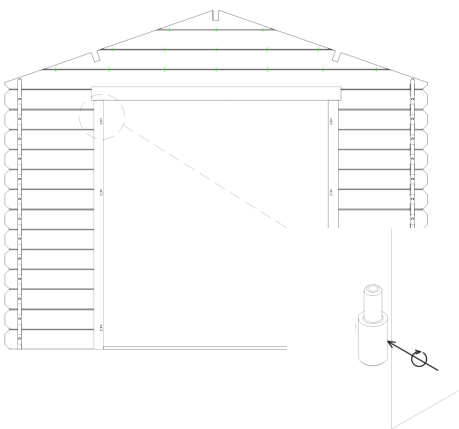

11

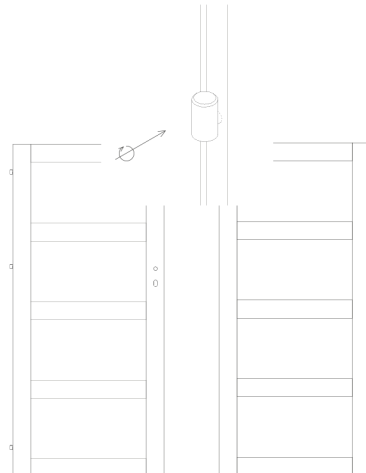

12

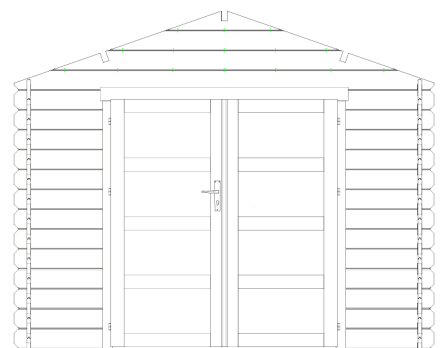

S8047C28

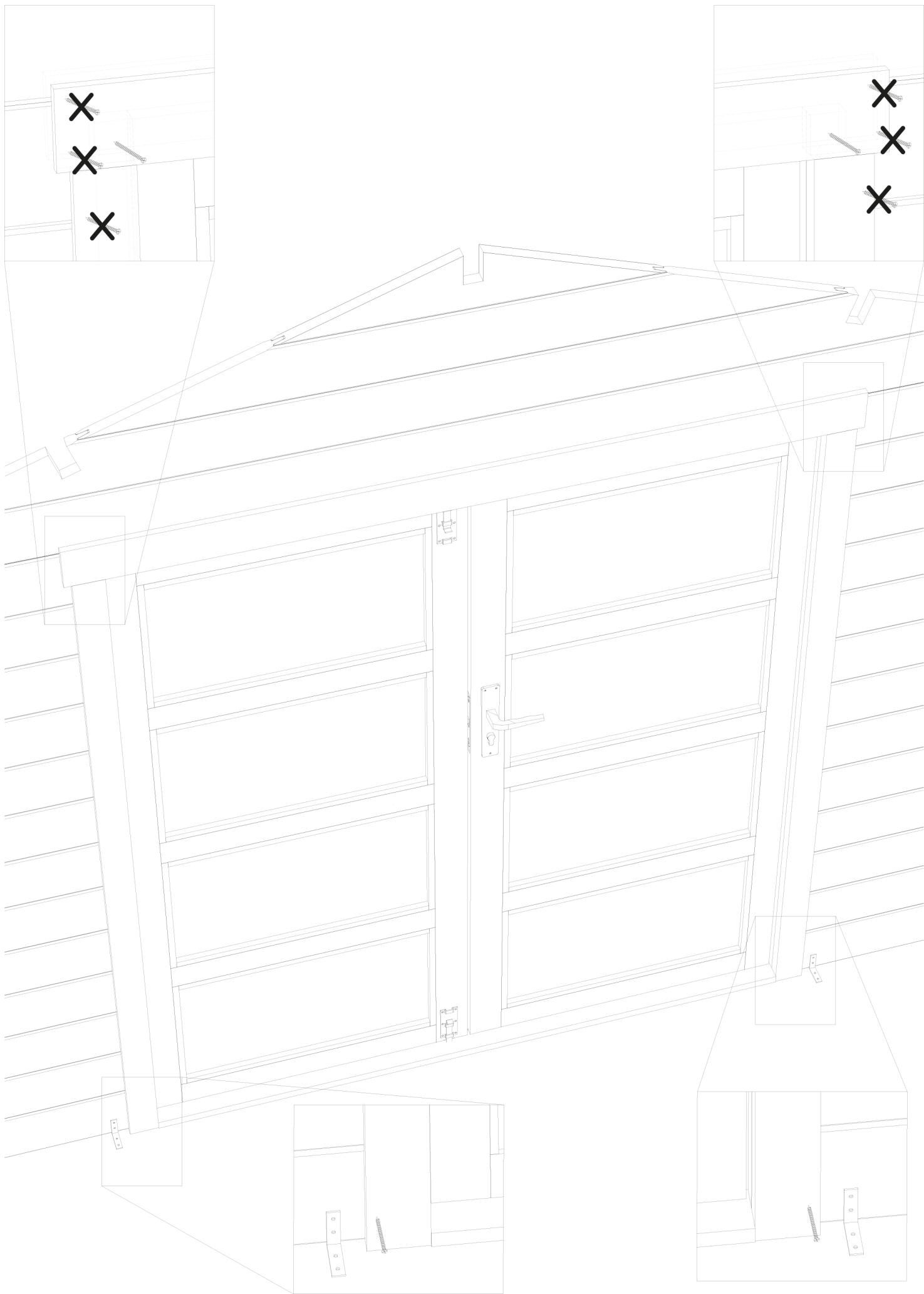

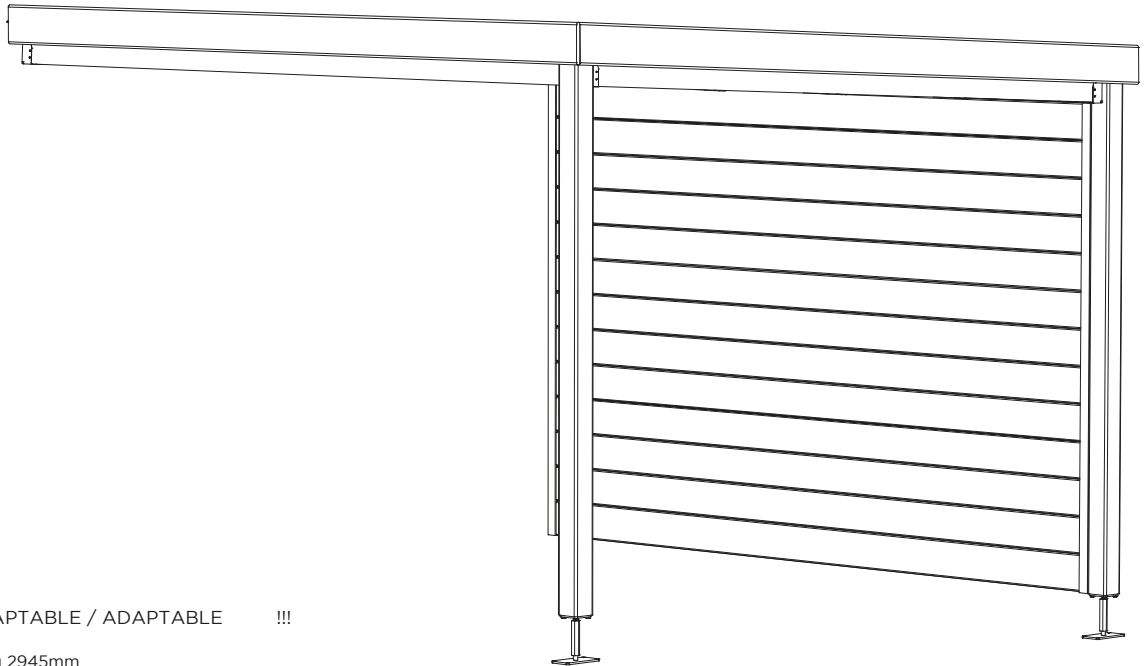

!!! AANPASBAAR / ADAPTABLE / ADAPTABLE !!!



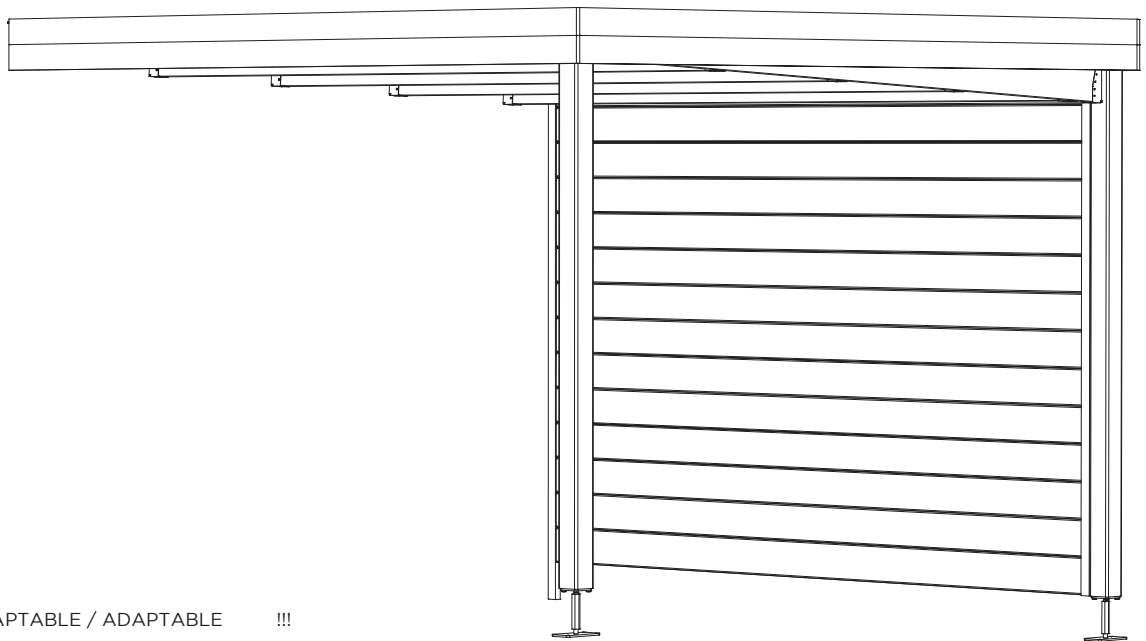











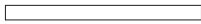
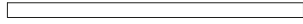
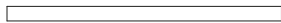
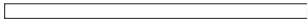

maximale breedte overkapping 2945mm
aanpassen naar kleinere breedte is mogelijk !!
largeur maximale du toit 2945mm
l'ajustement à une plus petite largeur est possible !!
maximum roof width 2945mm
adjusting to smaller width is possible !!



!!! AANPASBAAR / ADAPTABLE / ADAPTABLE !!!

maximale breedte overkapping 2945mm
aanpassen naar kleinere breedte is mogelijk !!
largeur maximale du toit 2945mm
l'ajustement à une plus petite largeur est possible !!
maximum roof width 2945mm
adjusting to smaller width is possible !!

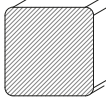
Stuklijst / Liste des pièces / Bill of material

	Ref.	Index	#
	↓	↓	↓
	G	WW028x149-PRF-000-0-2800	14
	J	WW016x095-PLA-000-0-2950	35
		ALTERNATIEF: Het kan productiematig zijn dat er andere planchettes J in de verpakking zitten. De referentie is dan WW016x120-PLA-000-0-2950 => aantal 28 stuks	
		ALTERNATIVE: Il peut être lié à la production que d'autres planchettes J soient incluses dans l'emballage. La référence est alors WW016x120-PLA-000-0-2950 => # 28 pièces	
		 ALTERNATIVE: It may be production-related that other planchettes J are included in the package. The reference is then WW016x120-PLA-000-0-2950 => # 28 pieces	
		ALTERNATIVE: Es kann produktionsbedingt sein, dass andere Planchetten J im Paket enthalten sind. Die Referenz ist dann WW016x120-PLA-000-0-2950 => # 28 Stück	
	H	WW028x040-4FA-000-0-2100	3
	H1	WW016x145-4R8-000-0-1950	2
	K	WW040x145-4FA-000-0-2945	5
	K1	WW040x145-4FA-000-0-2730	1
	M	WW016x145-4R8-000-0-3012	1
	M1	WW016x095-4FA-000-0-3100	4
	M2	WW028x040-4FA-000-0-1750	1
	R	S617  3.5 x 35 #20	3
	R1	S625  5.0 x 70 #20	1
	R2	S637  2.8 x 50 #100	2
	R3	S6810 M8 x 80	8
	S	S5515	2
	T	RW088x088-4R8-000-1-2100	2
	U	S6747 146	12

K = 5
 K1 = 1
 R = 24
 R1 = 12
 R3 = 8
 S = 2
 T = 2
 U = 12

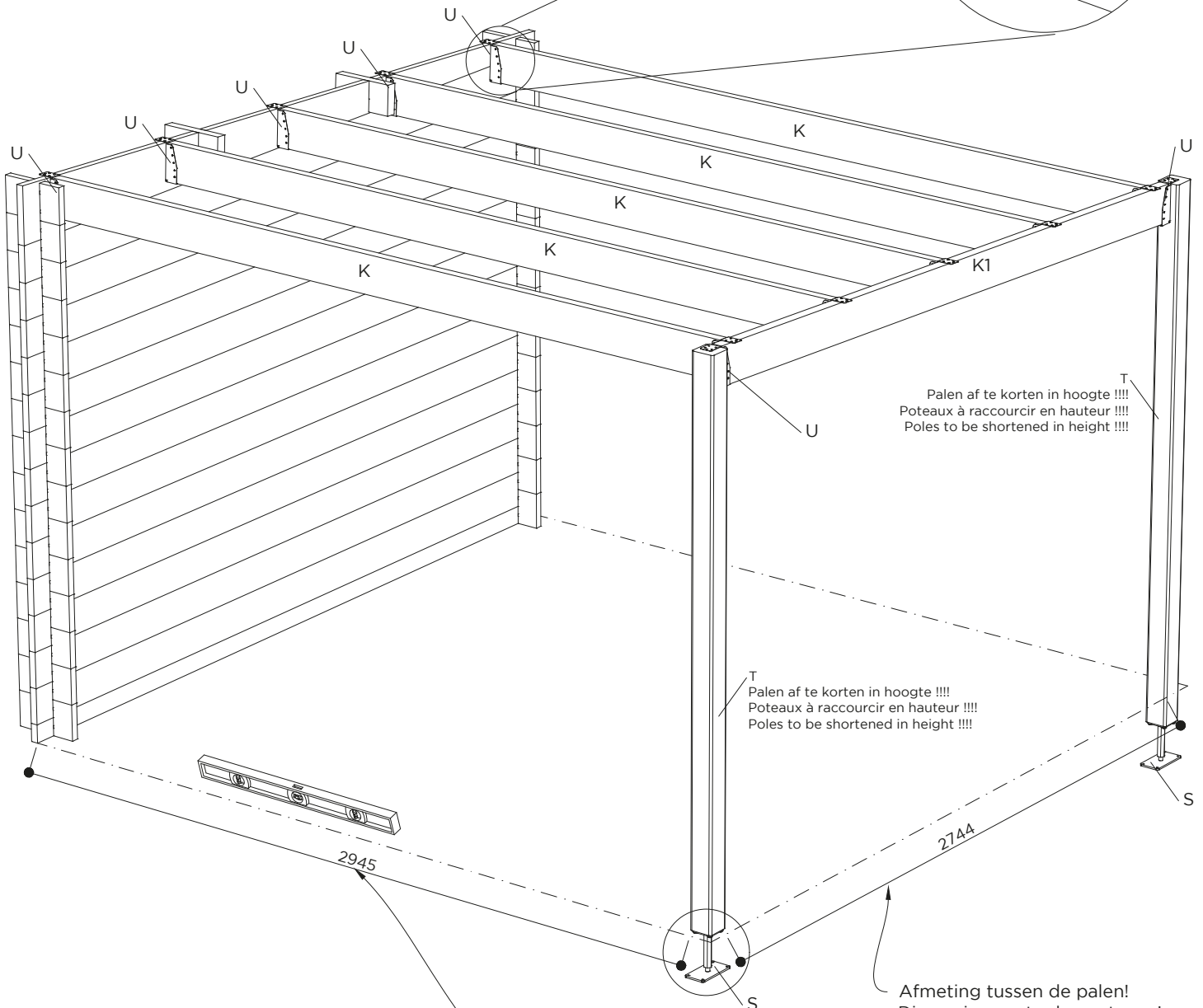
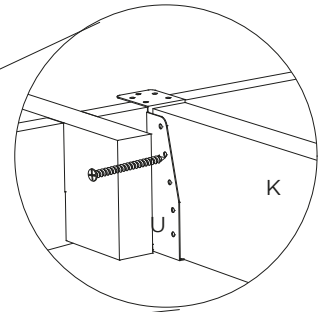
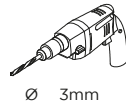
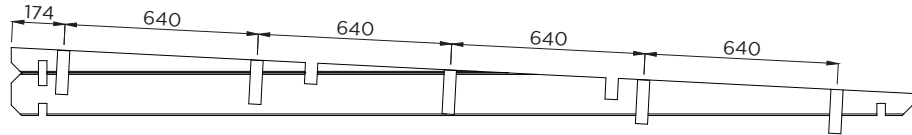

Palen af te korten in hoogte !!!!
 Poteaux à raccourcir en hauteur !!!!
 Poles to be shortened in height !!!!

Palen af te korten in hoogte !!!!
 Poteaux à raccourcir en hauteur !!!!
 Poles to be shortened in height !!!!

Afmeting tussen de palen!
 Dimensions entre les poteaux!
 Dimensions between the posts!

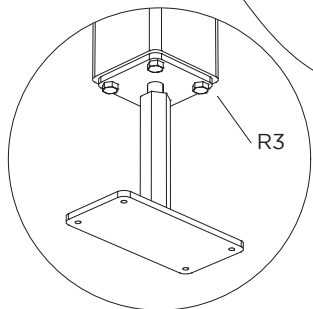

!!! AANPASBAAR / ADAPTABLE / ADAPTABLE !!!

onderdelen 'K' en 'G' af te korten volgens gewenste lengte
 les parties 'K' et 'G' peuvent être raccourcies selon la longueur souhaitée
 parts 'K' and 'G' can be shortened according to desired length

R = 8
R1 = 8

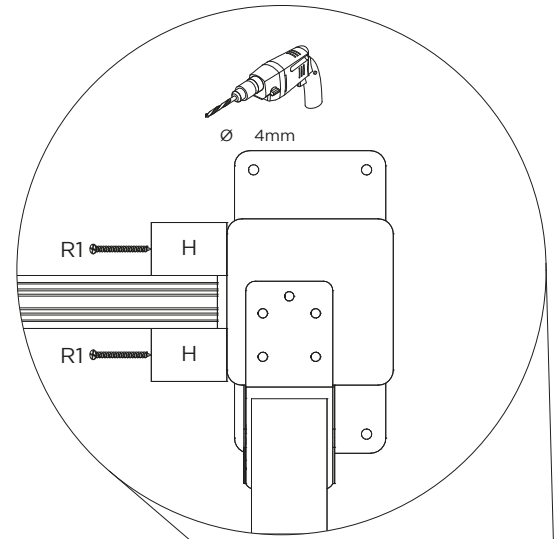
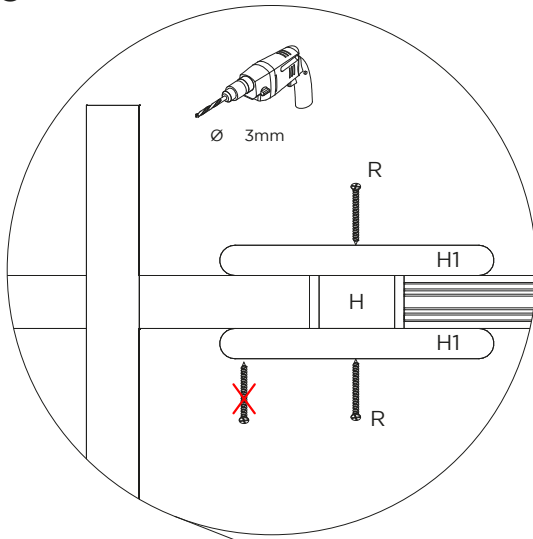

Opening werking hout !!!!
Ouverture dillation bois !!!!
Opening working wood !!!!

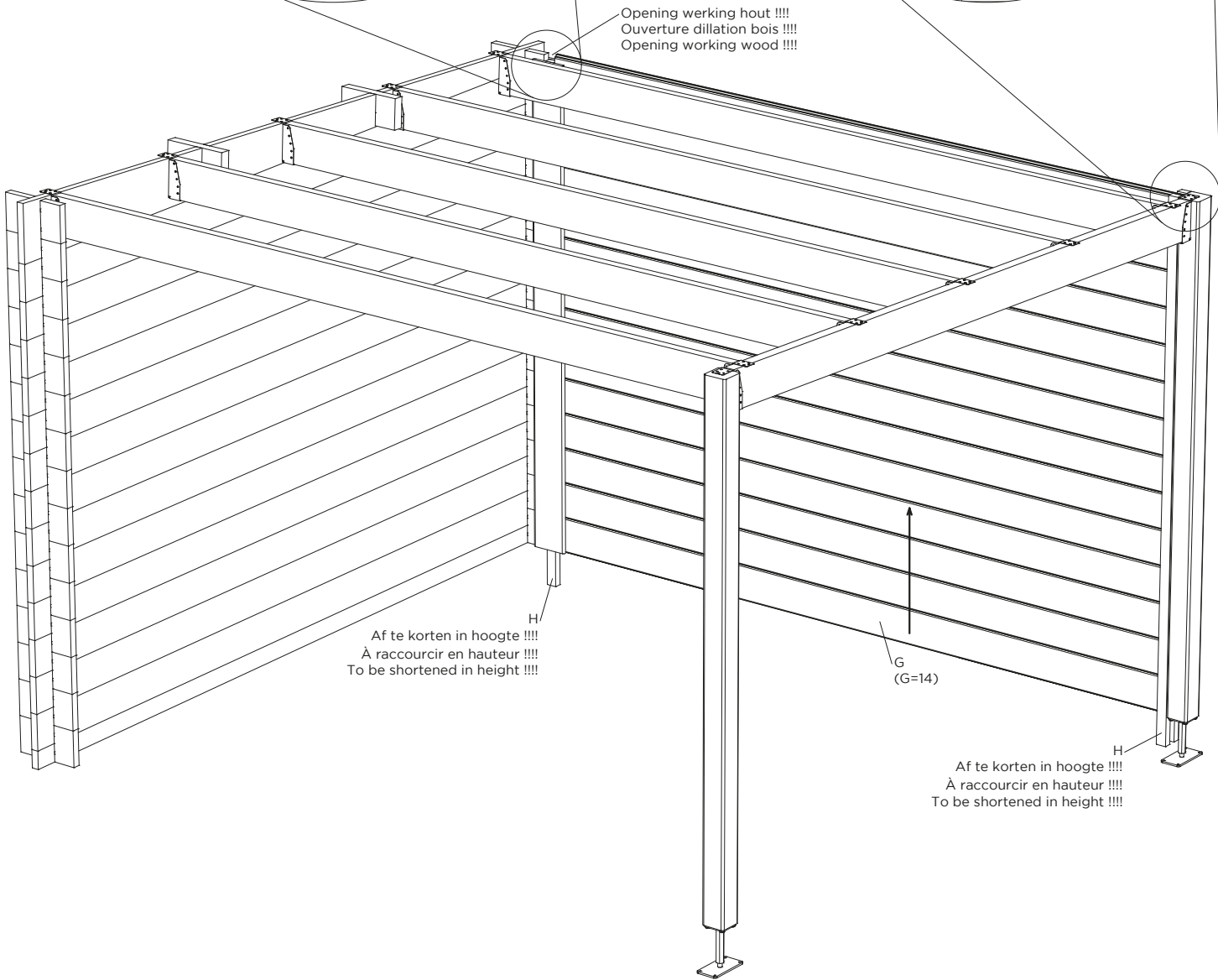

H
Af te korten in hoogte !!!!
À raccourcir en hauteur !!!!
To be shortened in height !!!!

H
Af te korten in hoogte !!!!
À raccourcir en hauteur !!!!
To be shortened in height !!!!

J = 35 of/ou/or/oder 28
2.8 x 50 # 92

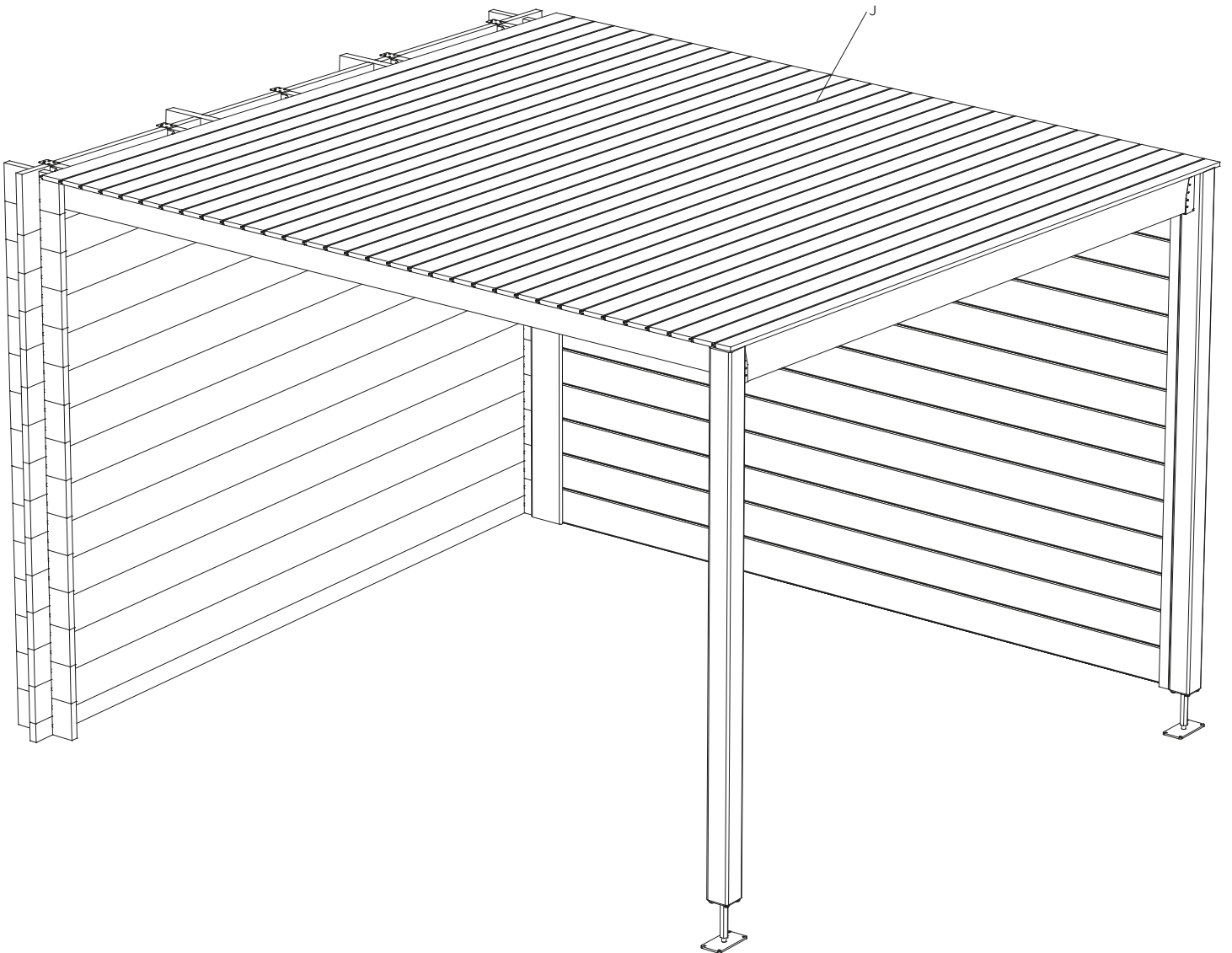
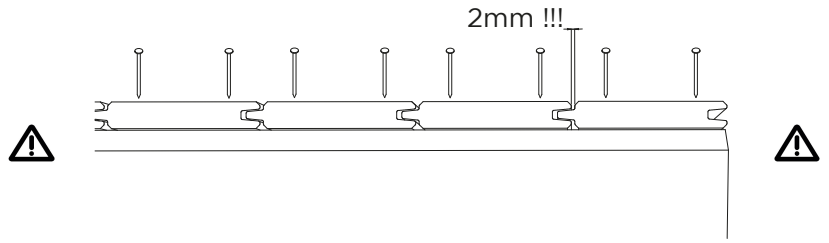

M = 1
2.8 x 50 # 20

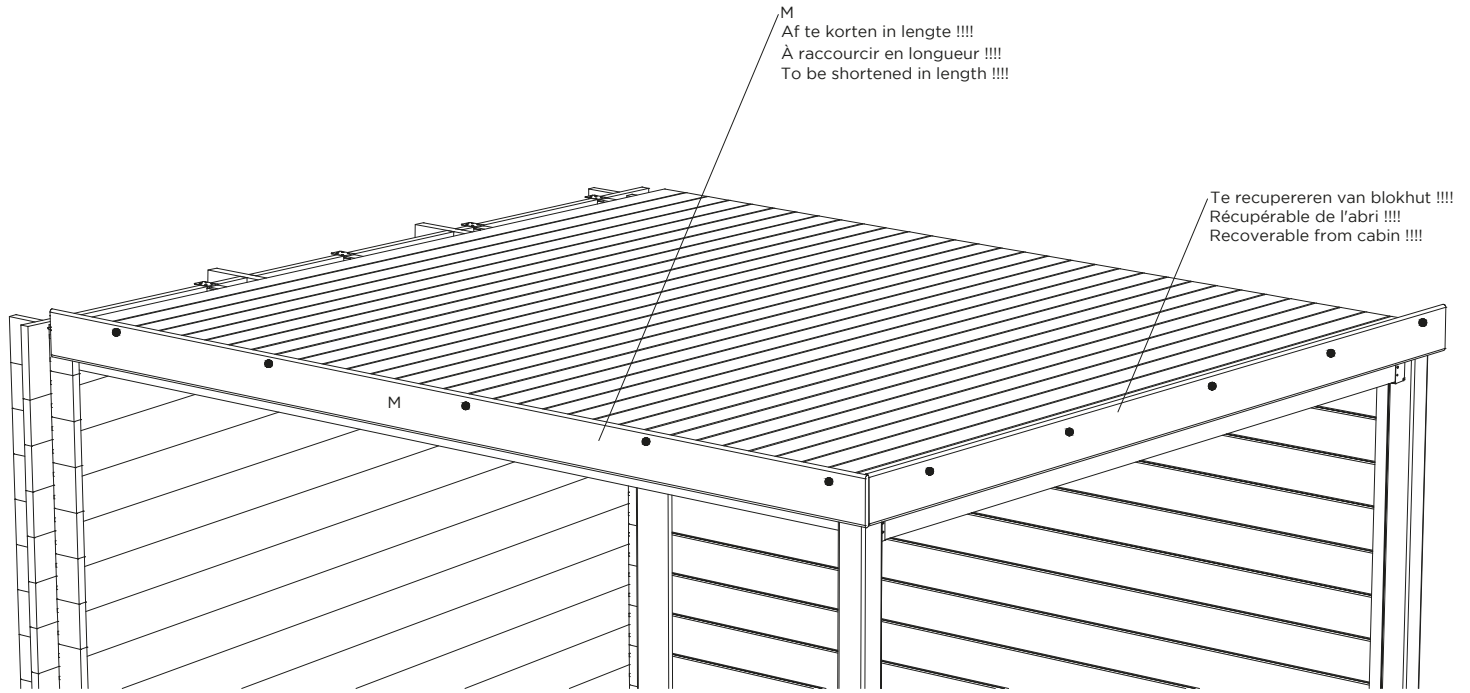
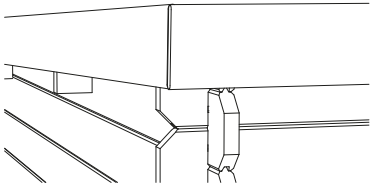

M
Af te korten in lengte !!!!
À raccourcir en longueur !!!!
To be shortened in length !!!!

Te recupereren van blokhut !!!!
Récupérable de l'abri !!!!
Recoverable from cabin !!!!

M1 = 4
M2 = 1
R = 28

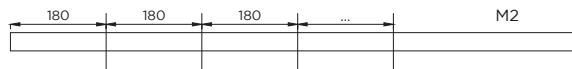
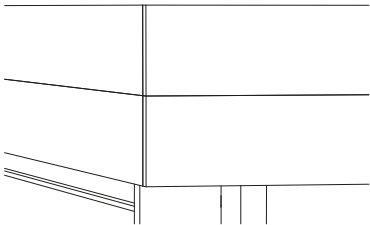

M1 + M2
Af te korten in lengte !!!!
À raccourcir en longueur !!!!
To be shortened in length !!!!

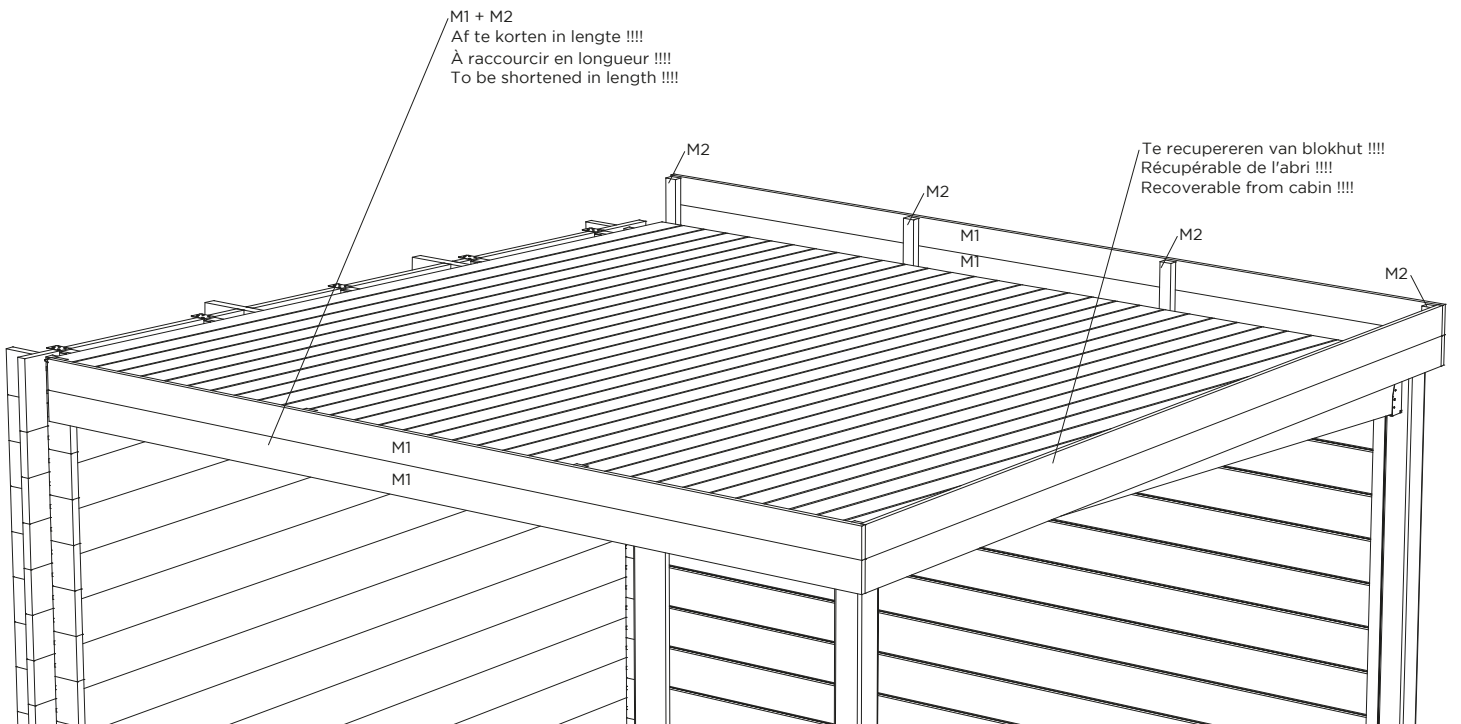

Te recupereren van blokhut !!!!
Récupérable de l'abri !!!!
Recoverable from cabin !!!!