

"Facet" 203 x 186

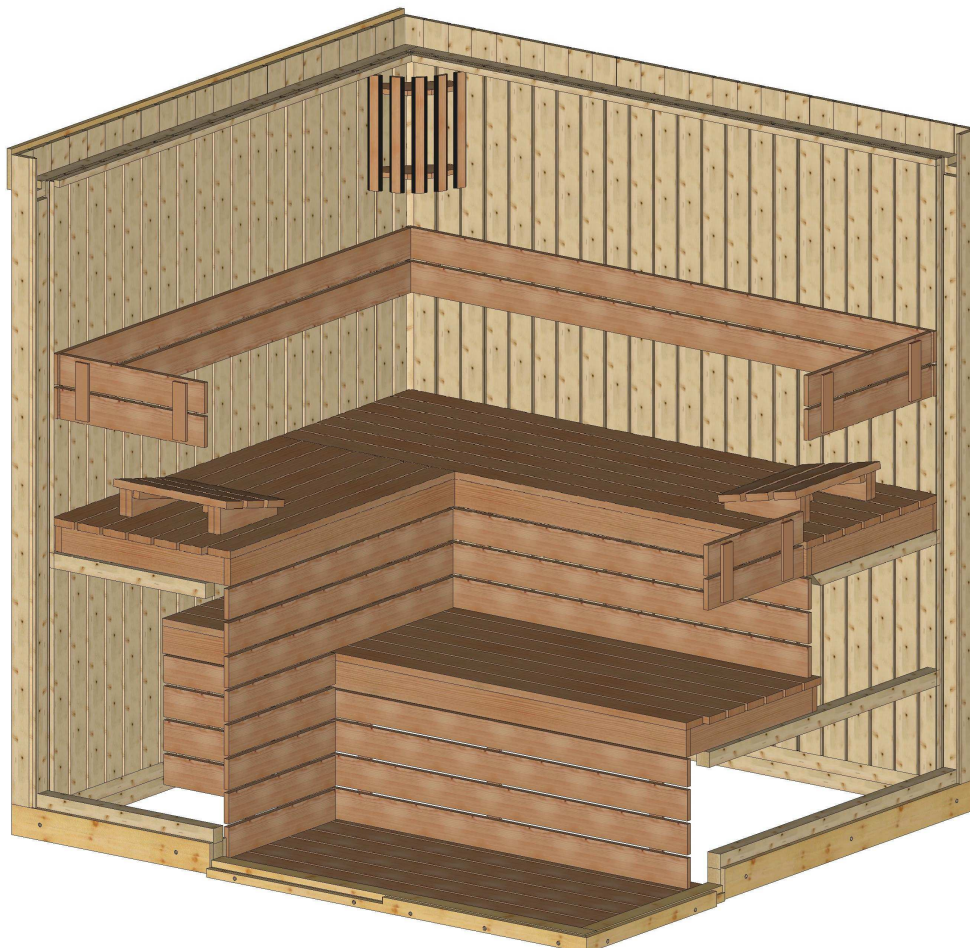

Bemerkung: die Ansicht von Türen, Fenster und anderen Teilen kann abweichen von diesem Bild

# Grundriss

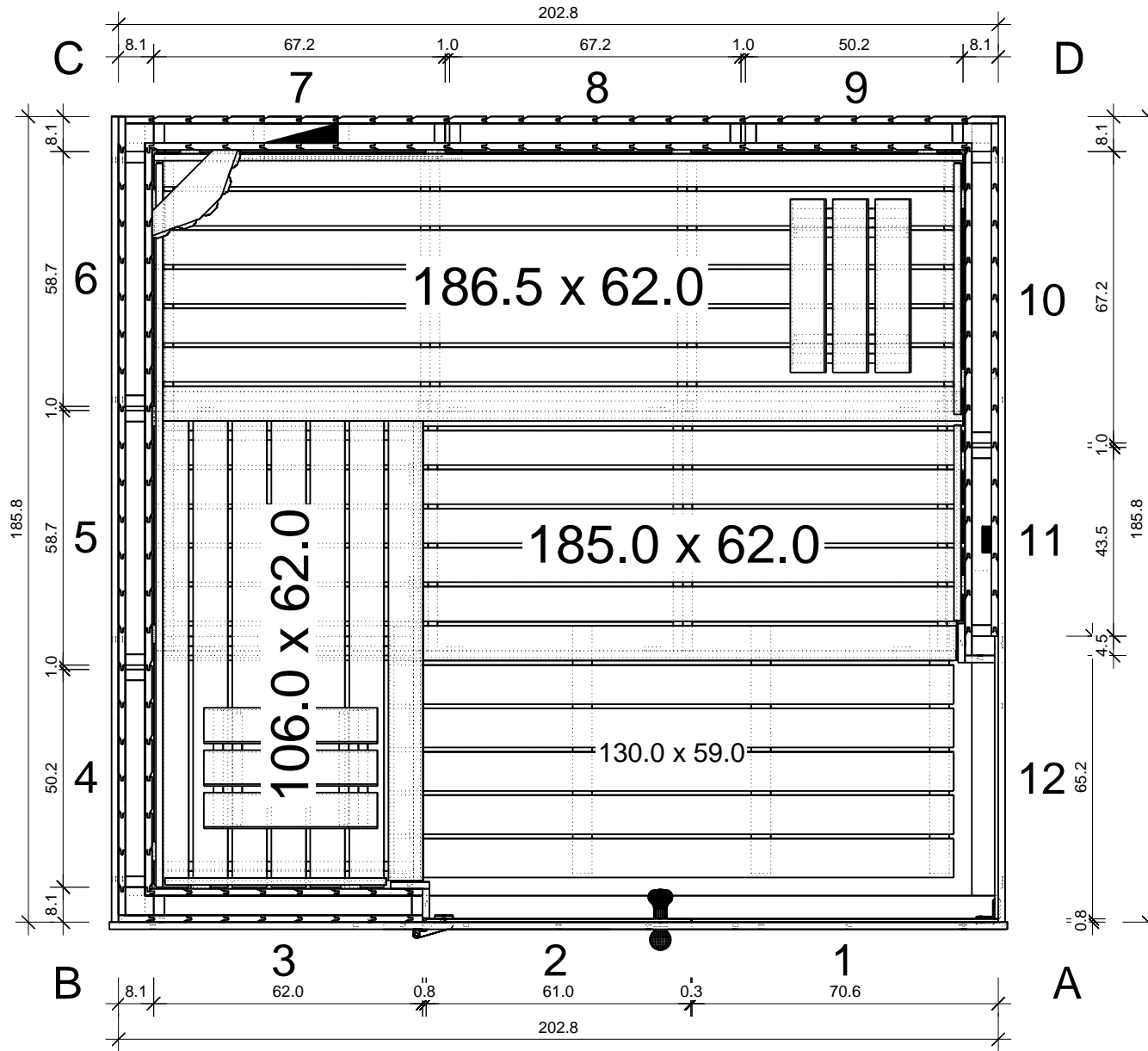

# "Facet" 203 x 186

## Schnitt

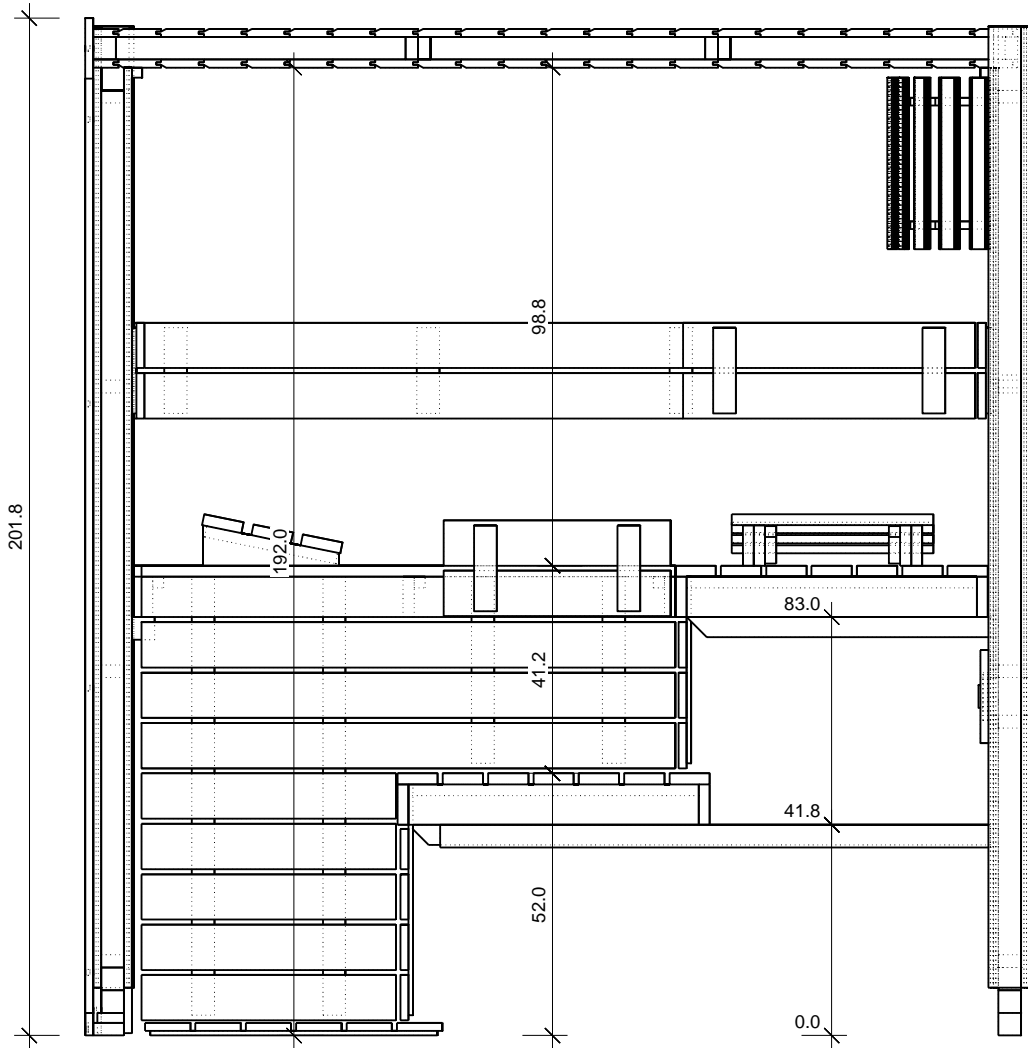

# Glaswand

## "Facet" 203 x 186

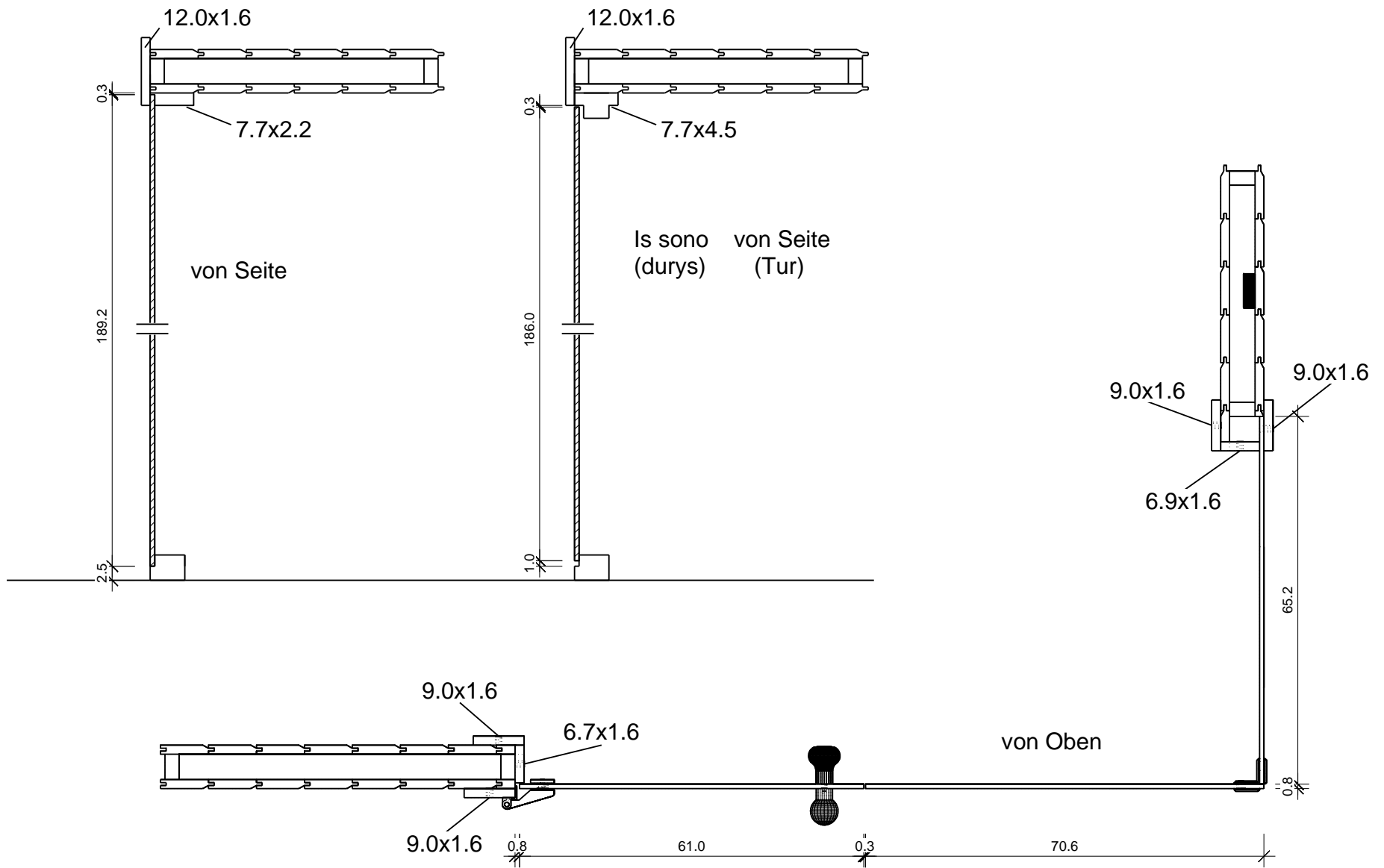

# Grundrahmen

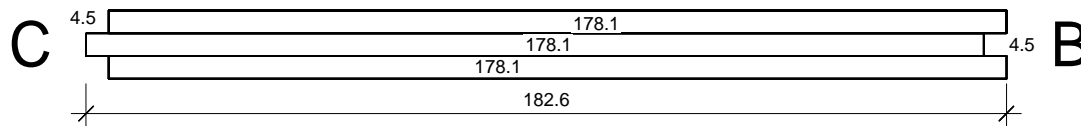
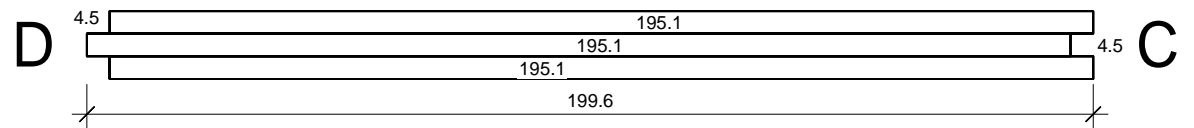
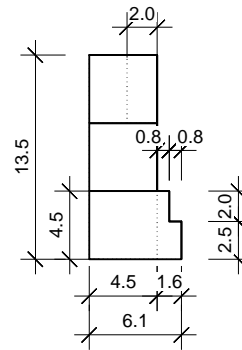
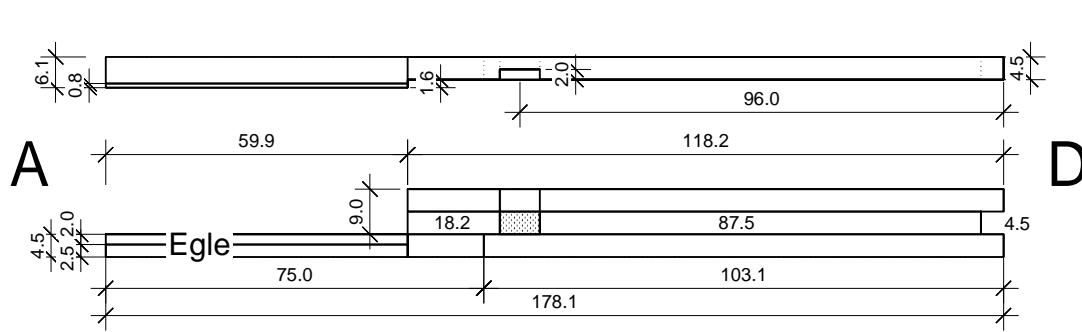
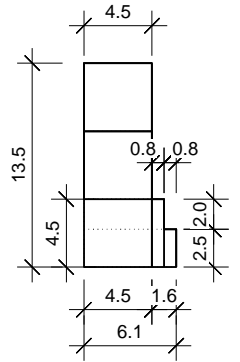
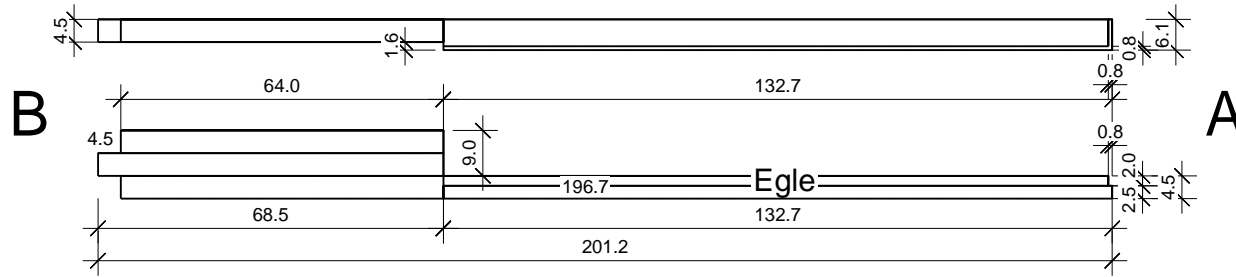
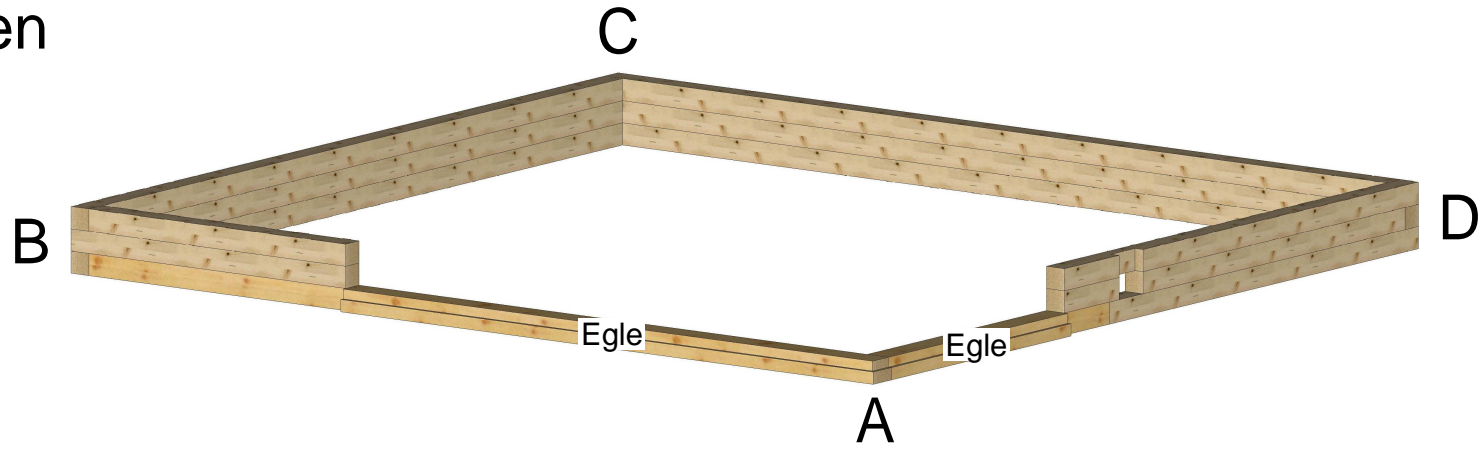

# Dachrahmen

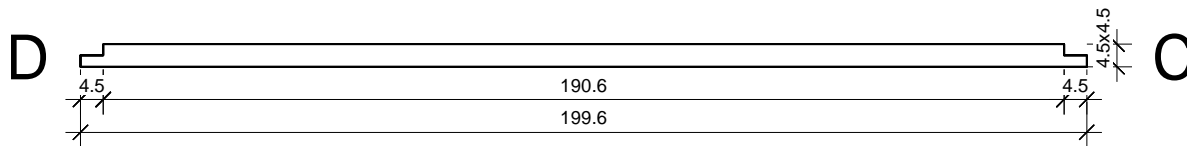
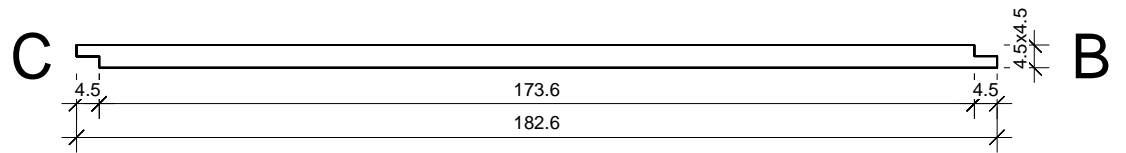
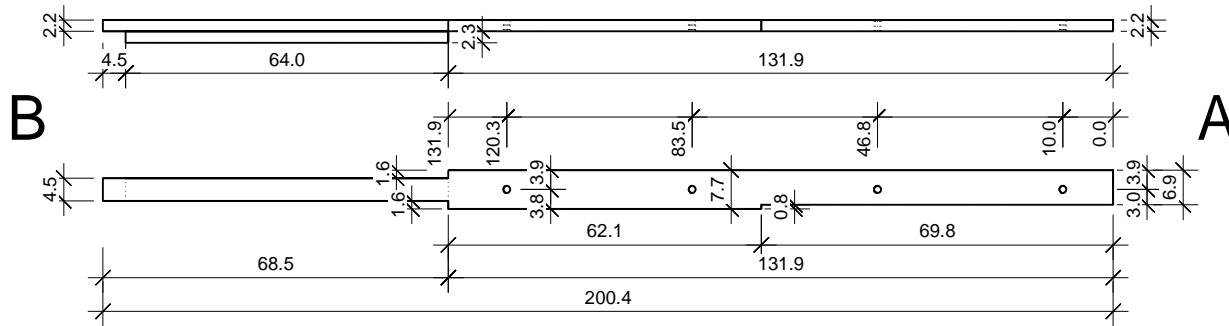
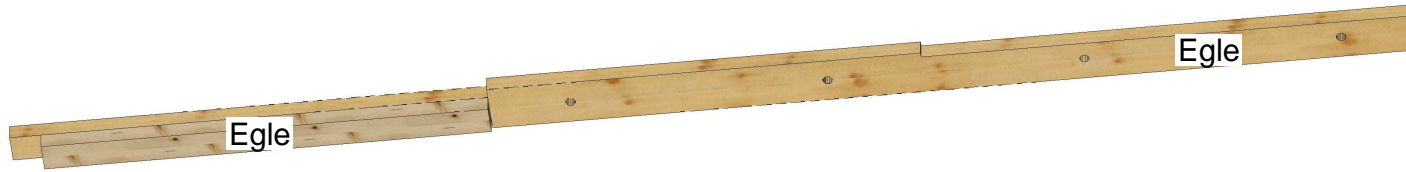
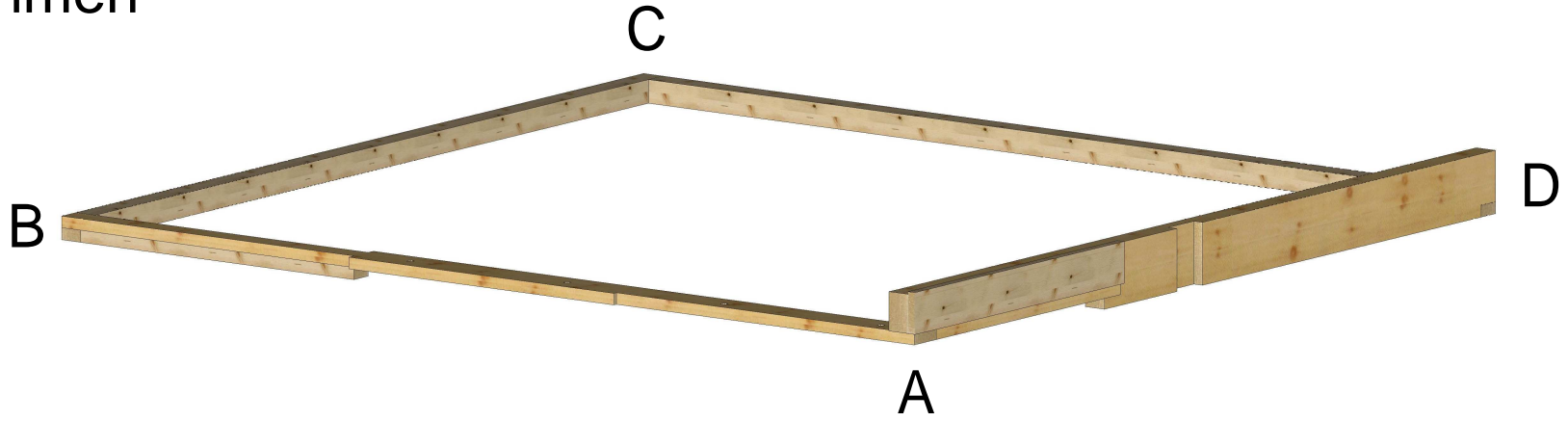

# Dachrahmen

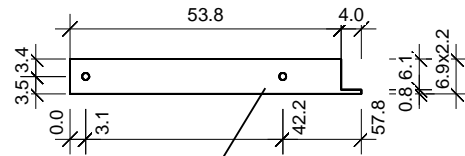
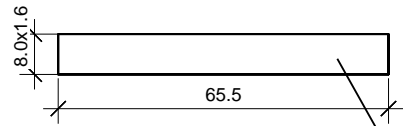

A

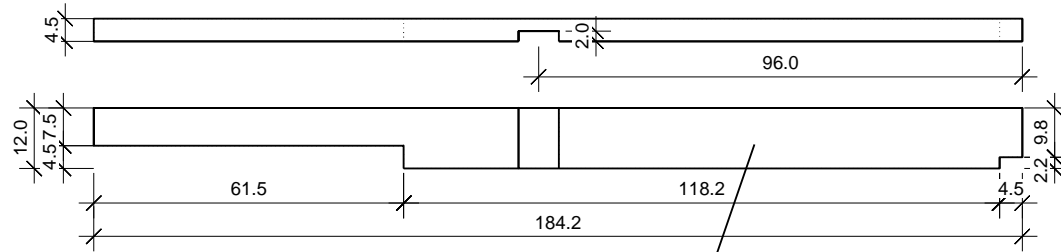

D

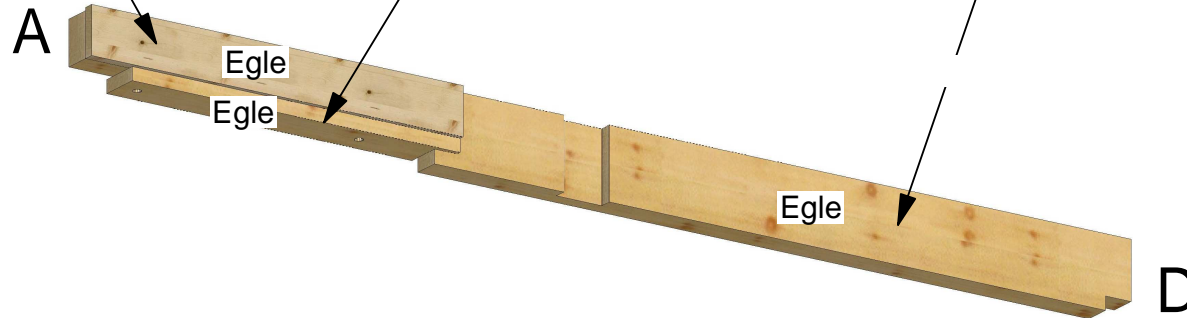
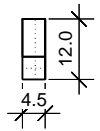

A

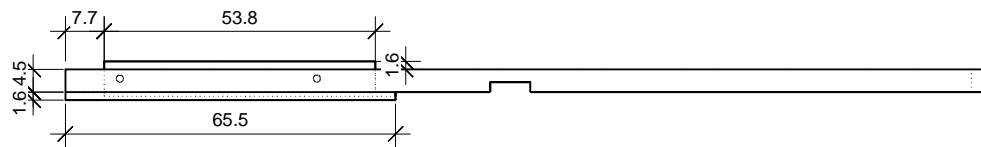

D

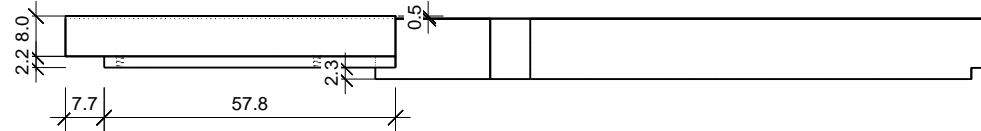

# Dachelemente

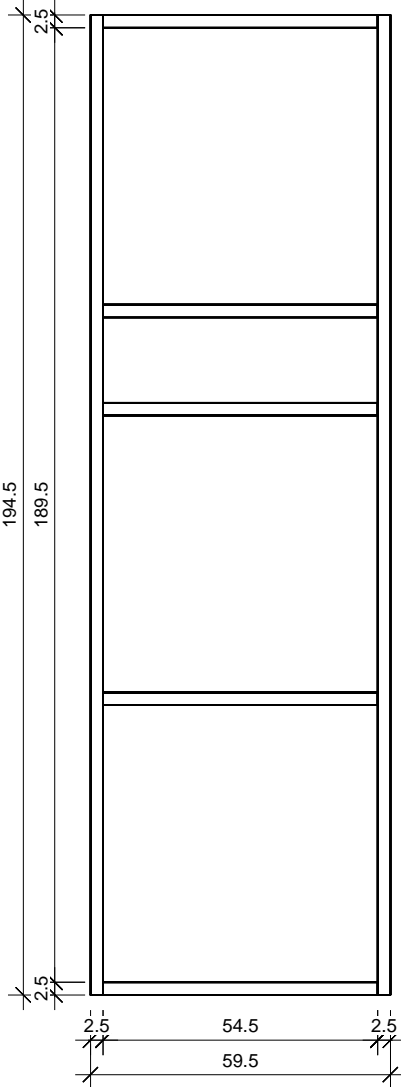
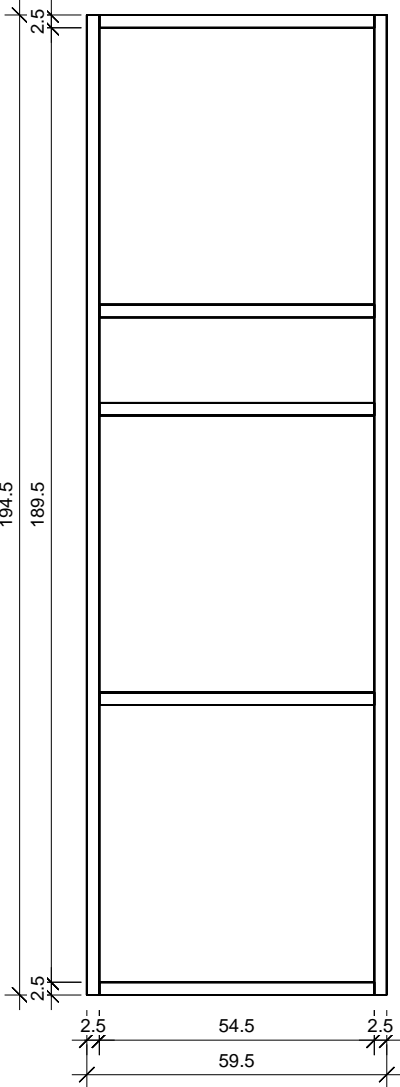
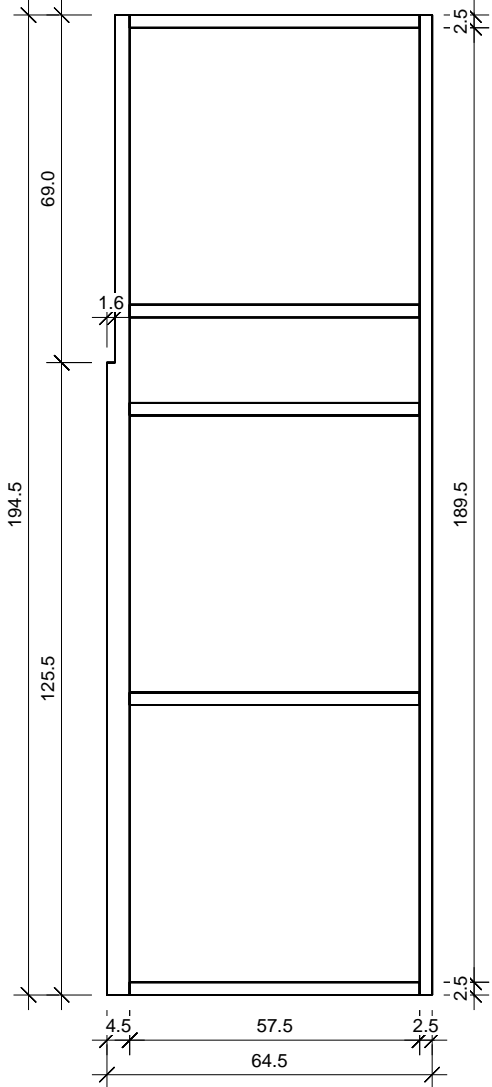
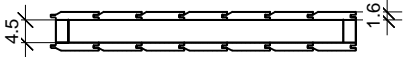
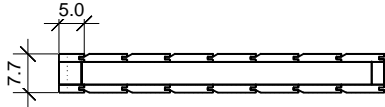



# Stiklai 8mm

