

S8715

NL

F

GB

D

Bedankt voor de aanschaf van dit product.

Nous tenons à vous remercier pour l'acquisition de ce produit.

Thank you for acquiring this product.

Vielen Dank für den Kauf dieses Produkt.

Bij eventuele schade of problemen, vragen wij u onze website **www.solid.eu/sav** te raadplegen en de procedure te volgen die op onze website uitgelegd wordt. Als u niet in de mogelijkheid bent om via het web de aanvraag te doen, vragen wij u te begeven naar de winkel waar u uw constructie heeft gekocht, samen met de beschadigde stukken (of met een foto) en met de **Stuklijst**, terug te vinden in het montageplan, zodat een eerste controle door de winkel uitgevoerd kan worden. Vergeet ook niet de barcode (beginnend met PO) mee te nemen of ze te vermelden op de **Stuklijst** op de voorziene plaats. U kan deze terug vinden op het etiket op de verpakking van de constructie ofwel op de leveringsbon. (zie uitleg hieronder)
 Al deze zaken zijn onontbeerlijk en dus noodzakelijk voor de behandeling van uw klacht.

En cas de problèmes ou de dégâts, nous vous invitons à vous rendre sur le lien internet suivant **www.solid.eu/sav** et à suivre la procédure indiquée sur la page web. S'il ne vous est pas possible de vous rendre sur internet, il vous est demandé de prendre contact avec le magasin où vous avez acheté votre produit, muni des pièces défectueuses (ou d'une photo) et la **Liste des pièces** figurant dans le plan de montage, afin qu'un premier contrôle puisse être effectué par le magasin. Veuillez transmettre le code barres (commençant par PO), ou le mentionner dans la **Liste des pièces** à l'endroit indiqué. Vous le trouverai sur l'étiquette de l'emballage de votre produit ou sur le bon de livraison (voir explication ci-dessous). Ces données sont indispensables au traitement de votre réclamation.

In case of problems or damages please visit our website **www.solid.eu/sav** and follow the instructions. If not possible to access our webpage by internet please contact the shop where the product was bought, provided with the flawed parts (or with a picture) and the **Bill of material** enclosed in the assembly plan, so that the shop can carry out a first control. Also communicate the following bar code (beginning with PO) or mention it in the **Bill of material** in the field provided. You can locate the bar code on the label fixed on the packaging or on the delivery order. (explained below) information is needed in order to handle your claim.

Bitte wenden Sie sich bei eventuellen Beschädigungen oder Problemen an unsere website **www.solid.eu/sav** und folgen sie unseren Website. Wenn Sie nicht in der möglichkeit die Anforderung über das internet zu machen, bitte wenden Sie sich an den Händler, bei dem Sie Ihr Produkt gekauft haben, und nehmen Sie die beschädigten Teile (oder ein Foto davon) sowie der **Materialliste**, das Sie im Montageplan finden, mit, sodass ihr Händler das Problem untersuchen kann. Bitte denken Sie auch an unten stehenden Barcode (beginnend mit PO). Nehmen Sie diesen ebenfalls mit oder geben Sie ihn an der dafür vorgesehenen Stelle auf dem **Materialliste** an. Sie können diese zurück finden auf das Etiket von der Verpackung der Konstruktion oder auf der Lieferschein (siehe Erklärung unten) Oben genannte Informationen und Dokumente sind für die Bearbeitung Ihrer Beschwerde notwendig.



- (NL)** Verpakking
- (F)** Emballage
- (GB)** Packaging
- (D)** Verpackung



- (NL)** Sticker
- (F)** Autocollant
- (GB)** Sticker
- (D)** Aufkleber



n° PO xxxxxxxxxxxx

Kopie pakbon 16.4.2025

SOLID
 creating outdoor comfort

Leveringsdatum: 14/03/2025	Leveringsadres eindpunt:	Aankomstpunt:
Client: ...	Opmerking: ...	Productcode: ...
Betaaldatum: ...	Opmerking: ...	Productcode: ...

Achtnummer	Ref klant	Omschrijving	Lengte	Kleur	Kwaliteit
S8715		...			

Serial ID: [redacted]

Handtekening: [redacted]

Totaal gewicht: 0,00 KG

Contacteer ons: ...

Totaal volume: ...

DE CLAUUSE VAN EIGENDOMVOORBEHOUD IS VAN TOEPASSING BIJ DEZE LEVERING IN GOEDE STAAT ONTVANGEN.

Theo. Baatman ...

- (NL)** Leveringsbon
- (F)** Bon de livraison
- (GB)** Delivery note
- (D)** Lieferscheibleg

Stuklijst / Liste des pièces / Bill of material / Materialliste

S8715

Code	Productnaam	Quantiteit
A	...	2
B	...	10
C	...	7
D	...	6
E	...	24
F	...	2
G	...	15
H	...	2
I	...	2
J	...	48
K	...	3
L	...	7
M	...	4
N	...	2
O	...	1
P	S8715 23	1

ALERT: ...

ALTERNATIEF: ...

gereedschap (excl.) / Outils (excl.) / Tools (excl.) / Werkzeuge (excl.)

- (NL)** Dienst na verkoop
- (F)** Service Après Vente
- (GB)** After Sales Service
- (D)** Kundendienst



S8715

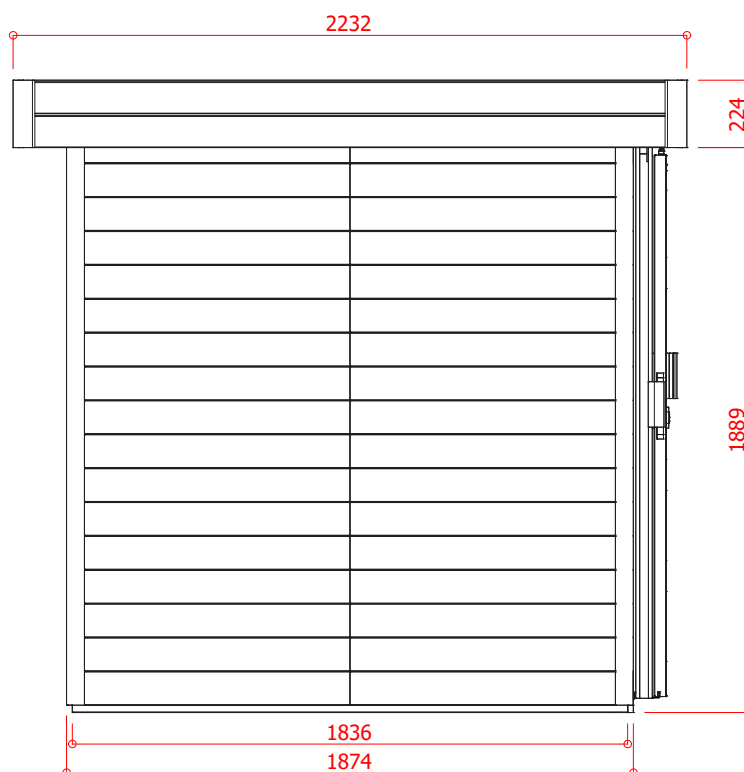
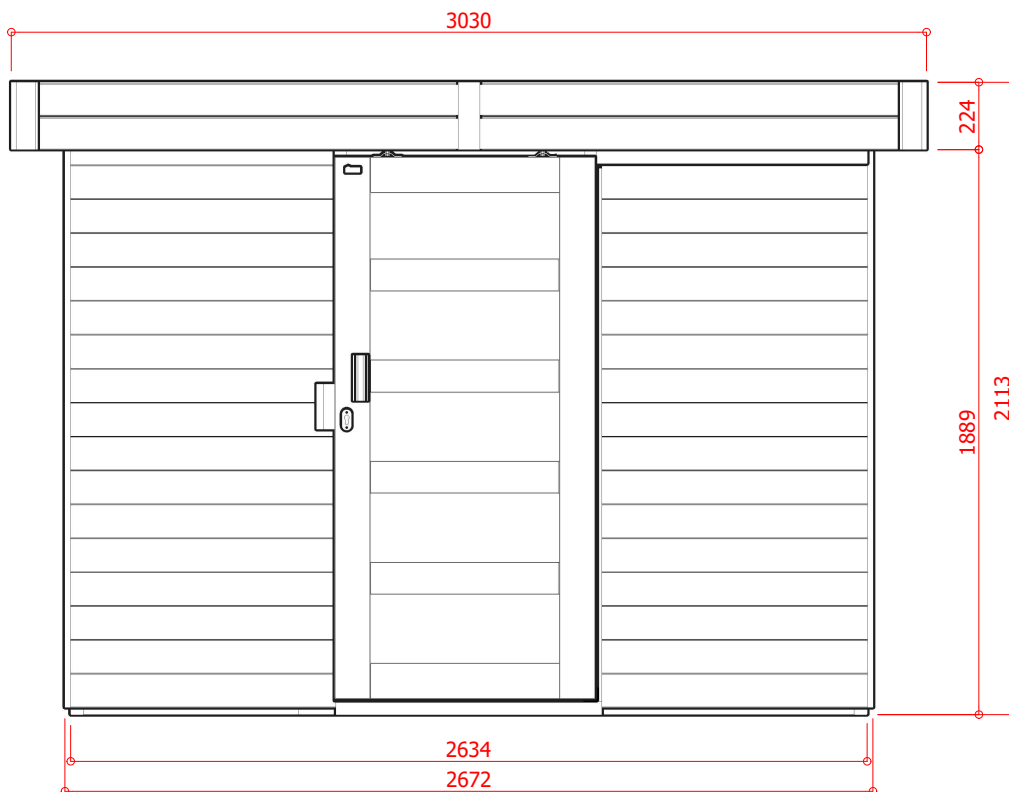

4.84m²



5.01m²



6.74m²

Industriepark 8
8587 Spiere-Helkijn

CreateDate: 09.12.2020
SaveDate: 09.12.2020
PlotDate: 09.12.2020

Deze technische tekening, montagehandleiding, afgeleide of detail ervan kan beschermd zijn door intellectuele eigendomsrechten en niets daarvan mag zonder schriftelijke toestemming van Solid NV worden gereproduceerd of gebruikt, anders dan het downloaden, het bekijken daarvan op een enkele computer en/of printen van een enkele hardcopy ten behoeve van persoonlijk, niet bedrijfsmatig gebruik. Elk ander gebruik van deze informatie (inclusief, maar niet beperkt tot, het geheel of gedeeltelijk reproduceren, de verdere verspreiding of distributie ervan onder welke vorm dan ook) is verboden en kan strafrechtelijk vervolgd worden. Met dank voor uw medewerking.

EAN code: 5412025087150



SOLID SUPERIA



S8715

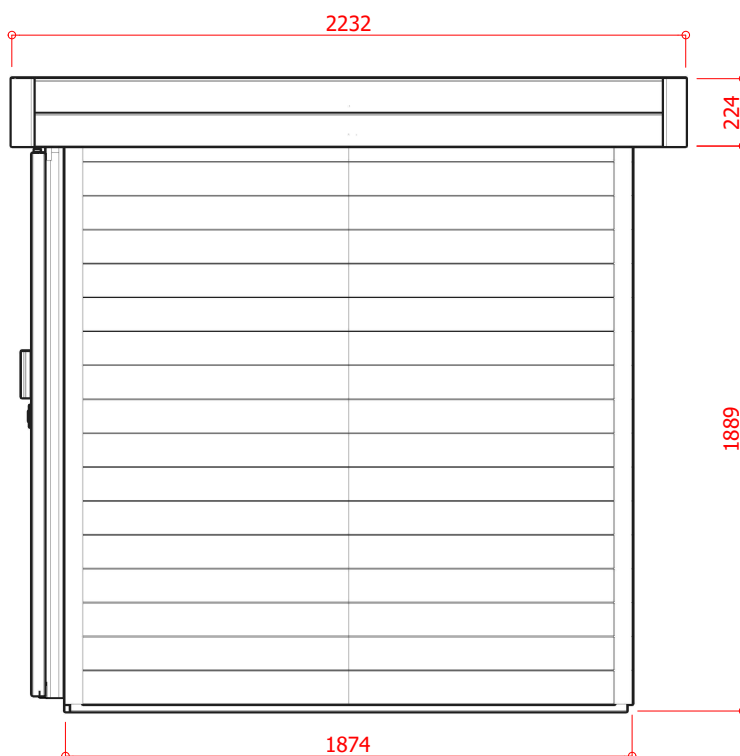
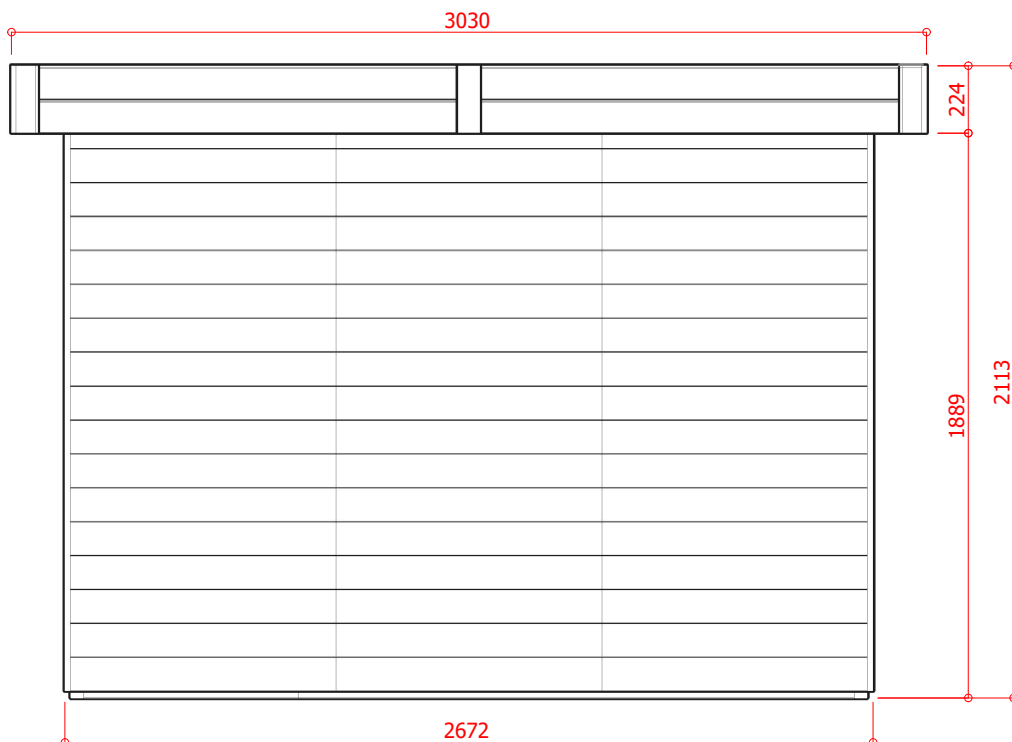

Industriepark 8
8587 Spiere-Helkijn

CreateDate: 09.12.2020
SaveDate: 09.12.2020
PlotDate: 09.12.2020

Deze technische tekening, montagehandleiding, afgeleide of detail ervan kan beschermd zijn door intellectuele eigendomsrechten en niets daarvan mag zonder schriftelijke toestemming van Solid NV worden gereproduceerd of gebruikt, anders dan het downloaden het bekijken daarvan op een enkele computer en/of printen van een enkele hardcopy ten behoeve van persoonlijk, niet bedrijfsmatig gebruik. Elk ander gebruik van deze informatie (inclusief, maar niet beperkt tot, het geheel of gedeeltelijk reproduceren, de verdere verspreiding of distributie ervan onder welke vorm dan ook) is verboden en kan strafrechtelijk vervolgd worden. Met dank voor uw medewerking.

EAN code: 5412025087150



SOLID SUPERIA

S8715

Ref.

Index

#

ok/nok

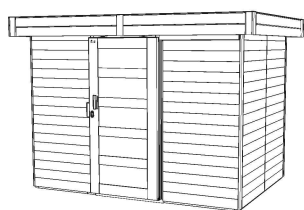

PO

Afmetingen, uiterlijk, vorm, gewicht kunnen afwijken.
 Les dimensions, l'apparence, la forme, le poids peuvent différer.
 Dimensions, appearance, shape, weight may differ.
 Maße, Aussehen, Form, Gewicht können abweichen.

	↓		↓		↓
	V	WW044x044-4FA-000-0-	1836	4	
	V1	WW044x044-4FA-000-0-	710	2	
	A1	WW019x878-TPP-CPR-0-	1915	7	
	A2	WW019x878-TPP-CPR-0-	2027	2	
	A3	WW019x878-TPP-CPR-0-	235	1	
	C1A	WW019x123-1IF-CPR-0-	1756	1	
	C2A	WW019x123-1IF-CPR-0-	1756	1	
	C3	WW040x145-1IF-CPR-0-	145	6	
	C4	WW040x55-1IF-CPR-0-	145	6	
	D	WW056x095-1IF-CPR-0-	2000	2	
	E	WW019x044-2IF-CPO-0-	878	1	
	F	WW016x090-AV1-CPO-0-	1600	1	
	J2	WW016x095-PLA-000-0-	2120	34	
	L	WW016x040-2IF-CPO-0-	2120	4	
	M	WW016x236-PLA-000-0-	1500	2	
	M1	WW016x236-PLA-000-0-	1500	2	
	M2	WW016x236-2R8-RAI-0-	2164	2	
	N	WW019x059-4FA-000-0-	2038	2	
	K	WW028x095-4FA-000-0-	2000	2	

Gereedschap (excl.) / Outils (excl.) / Tools (excl.) / Werkzeuge (exkl.)

Hamer Marteau Hammer Hammer	Schroefboormachine Perceuse / Visseuse Screw drill Schraubenbohrer	Ladder Echelle Ladder Leiter	Winkelhaak Crochet carré Square hook Quadratischer Haken	Cirkelzaag Scie circulaire Circular saw Kreissäge	Klokbuur Ø 60mm Scie cloche Ø 60mm Hole saw Ø 60mm Bohren Ø 60mm
Handzaag Scie à main Saw Säge	Meter Mètre Meter Rollenmesser	Breekmas Couteau Cutter Messer	Waterpas Niveau à bulle Plumb rule Wasserwaage	Decoupeerzaag Scie sauteuse Jigsaw Stichsäge	Silicone + pomp Silicone + pompe Silicone + pump Silikon + Pumpe

Stuklijst / Liste des pièces / Bill of material / Materialliste



S8715

Ref.

Index

#

ok/nok

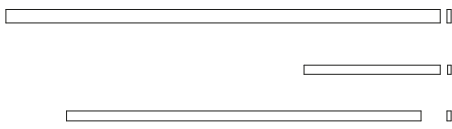

N1 WW019x059-4FA-000-0- 1926 2

N2 WW016x040-4FA-000-0- 600 1

S WW028x059-2IF-CPO-0- 1762 2



P2 WW036x058-2IF-CPO-0- 150 1

S505

O Roofing 10.70 m 1

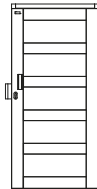
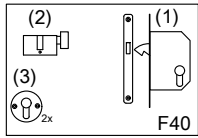

P S8050

- 1 x S8050
- 1 x PIR
- 1 x P1L
- 1 x P2
- 1 x ALU
- 2 x P4
- 1 x S3
- 5 x S5246 (glass 249mm x 650mm)

- + S676 F40 (1)
- + S677 (2)
- + S6861 (3)

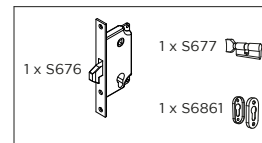

P4

2

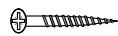

3 x 30 (20)

3 x 35 (48)

3 x 40 (3)

4 x 45 (116)

4 x 60 (10)

5 x 60 (24)

5 x 90 (4)

2.5 x 40 (110)

2.5 x 16 (100)

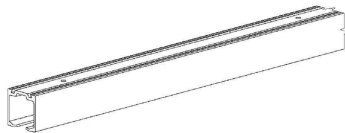
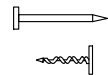

S564

1



S565

1



S6477

1



S678-R-ASK

2

Afmetingen, uiterlijk, vorm, gewicht kunnen afwijken.
Les dimensions, l'apparence, la forme, le poids peuvent différer.
Dimensions, appearance, shape, weight may differ.
Maße, Aussehen, Form, Gewicht können abweichen.

Gereedschap (excl.) / Outils (excl.) / Tools (excl.) / Werkzeuge (exkl.)



Hamer
Marteau
Hammer
Hammer



Schroefboormachine
Perceuse / Visseuse
Screw drill
Schraubenbohrer



Ladder
Echelle
Ladder
Leiter



Winkelhaak
Crochet carré
Square hook
Quadratischer Haken



Cirkelzaag
Scie circulaire
Circular saw
Kreissäge



Klokboor Ø 60mm
Scie cloche Ø 60mm
Hole saw Ø 60mm
Bohren Ø 60mm



Handzaag
Scie à main
Saw
Säge



Meter
Mètre
Meter
Rollenmesser



Breekmas
Couteau
Cutter
Messer



Waterpas
Niveau à bulle
Plumb rule
Wasserwaage



Decoupeerzaag
Scie sauteuse
Jigsaw
Stichsäge



Silicone + pomp
Silicone + pompe
Silicone + pump
Silikon + Pumpe

V = 4

V1 = 2

1

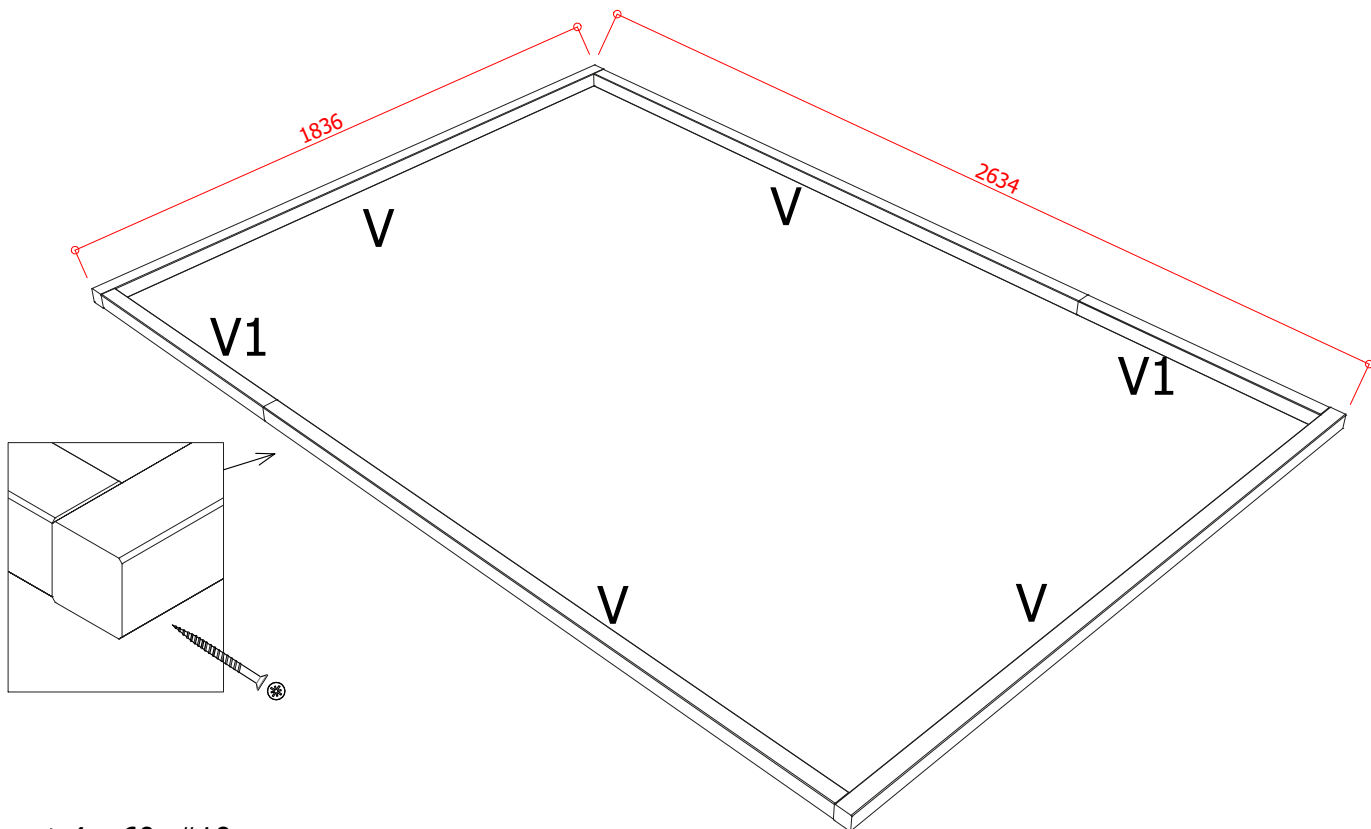

4 x 60 #10

A1 = 7

2

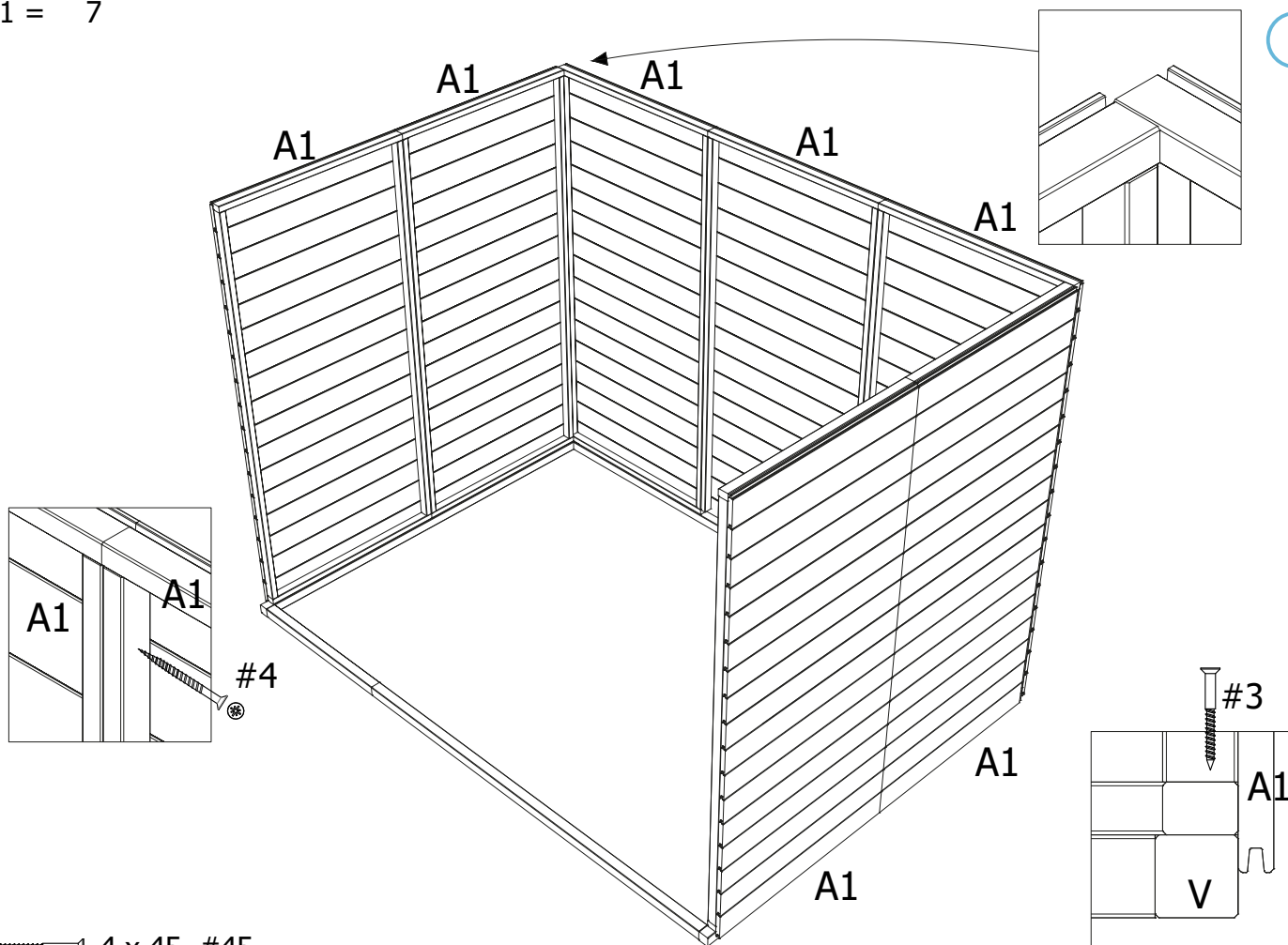

4 x 45 #45

A2 = 2
 A3 = 1
 E = 1

3

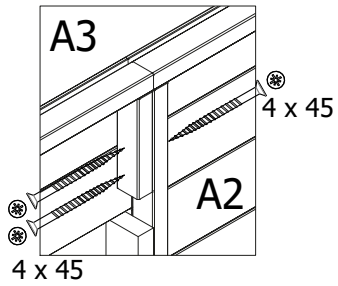
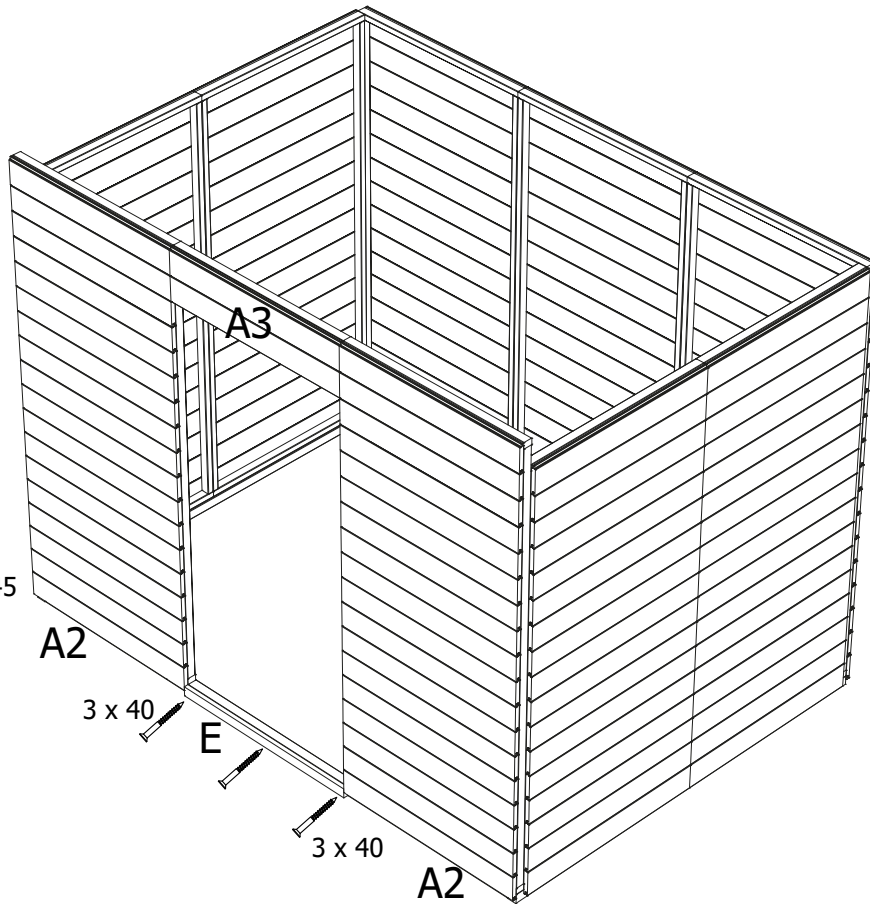

3 x 40 #3
 4 x 45 #6



C1 = 1
 C2 = 1
 D = 2
 D = 2
 K = 2

4 x 45 #32

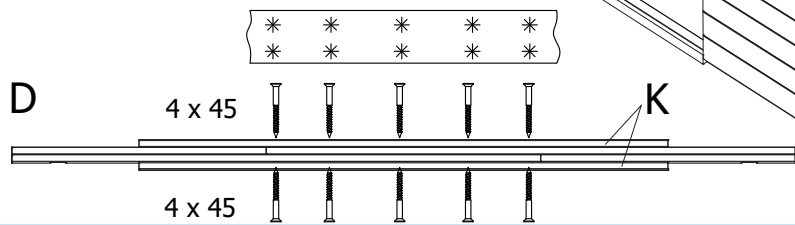
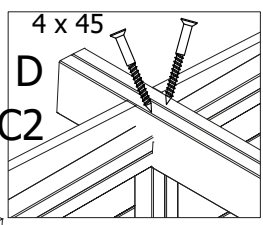
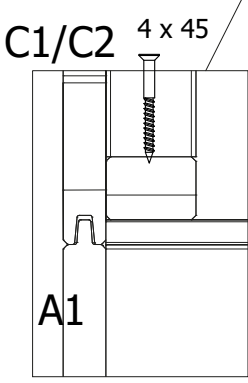
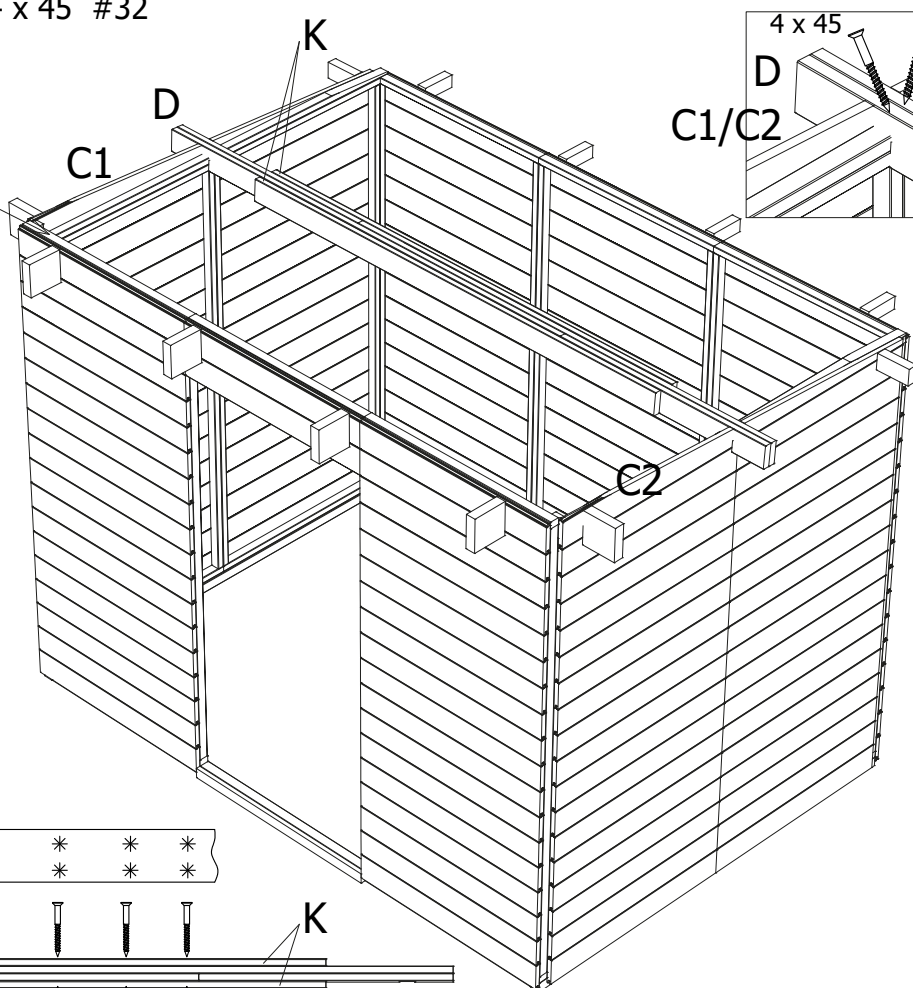
4

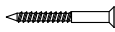

S8715

- C3 = 6  3 x 30 #4
- C4 = 6  4 x 45 #10
- S = 2  5 x 60 #24

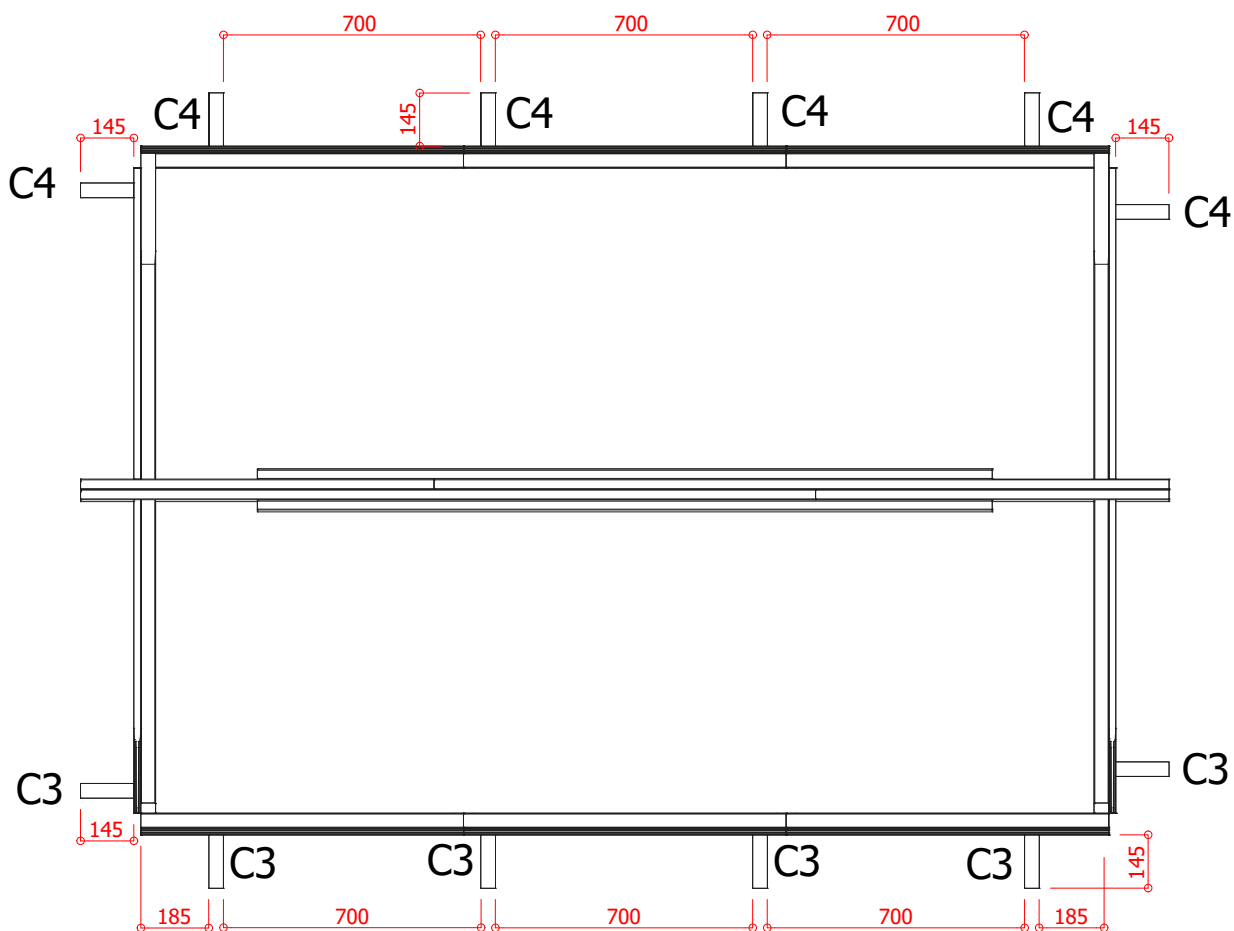
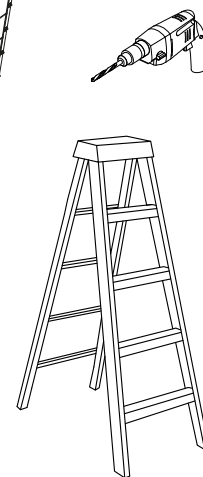
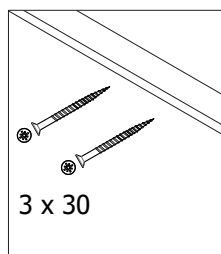
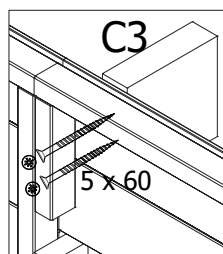
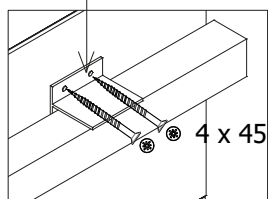
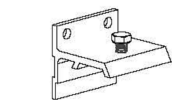
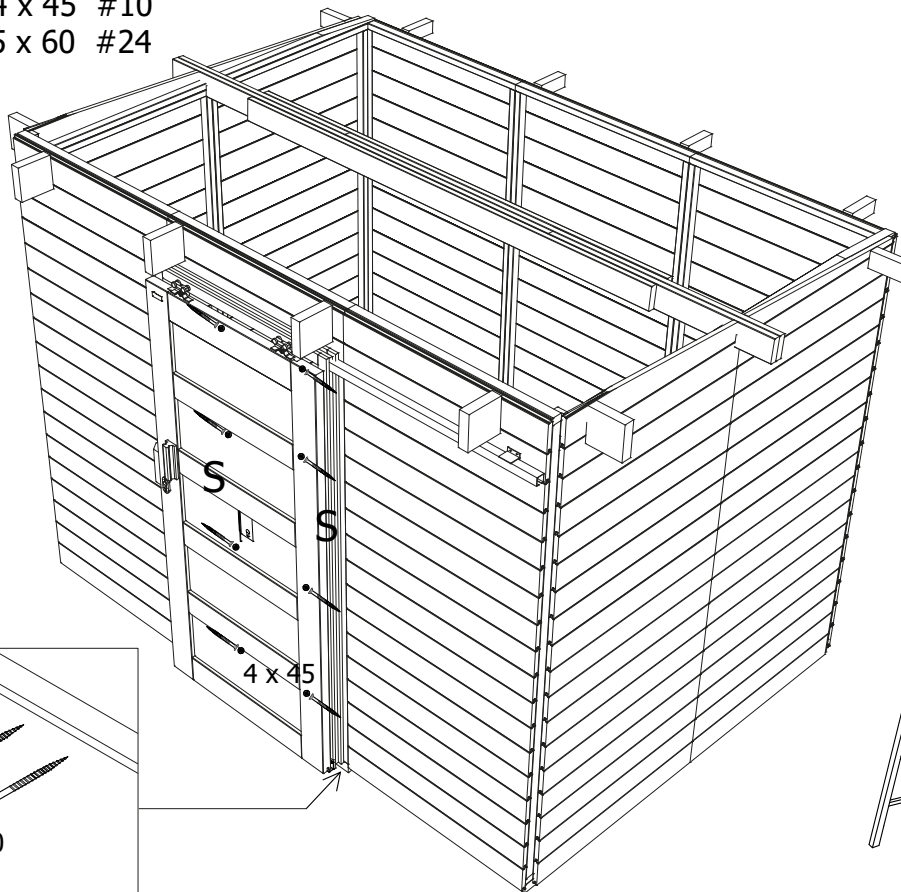

F = 1
P2 = 1
P4 = 2
S8050 #1

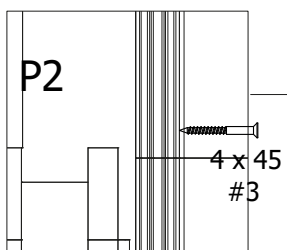
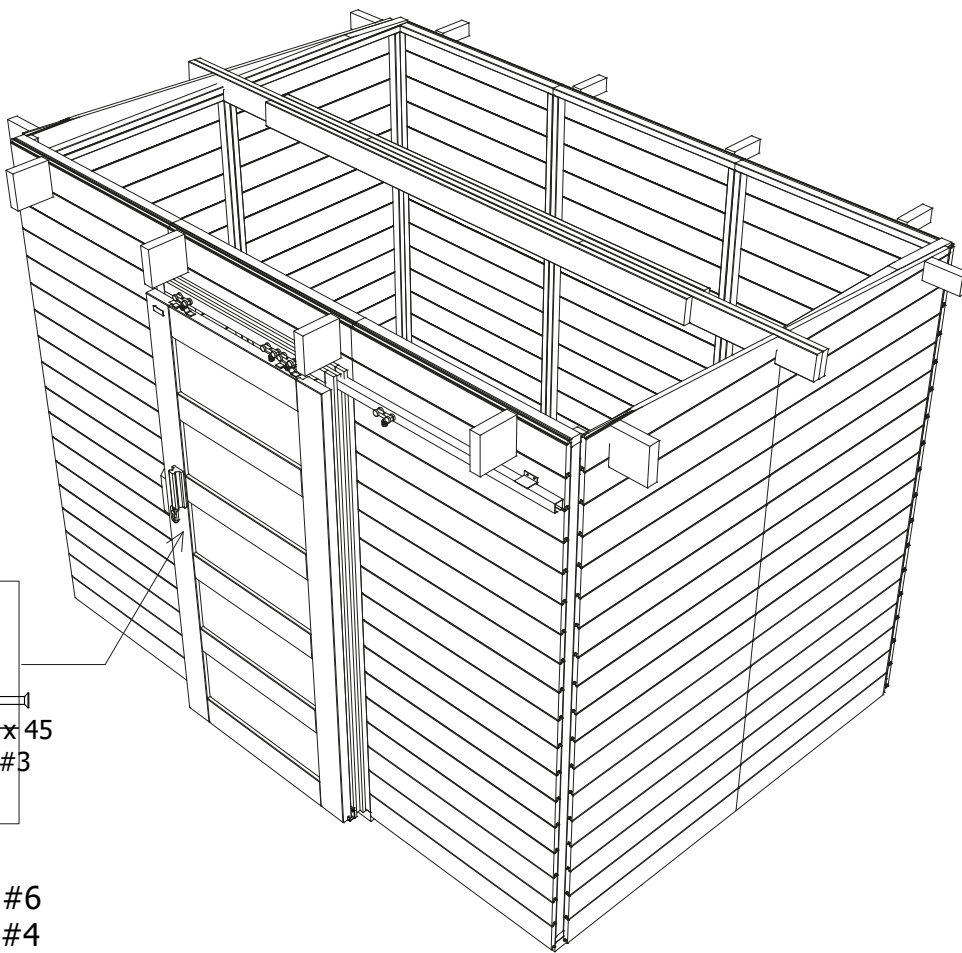

4 x 45 #6

5 x 90 #4

S678-R-ASK
#2

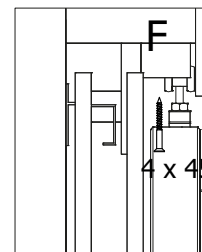
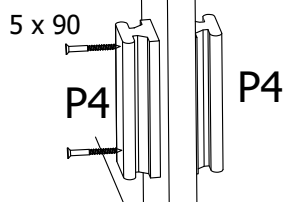
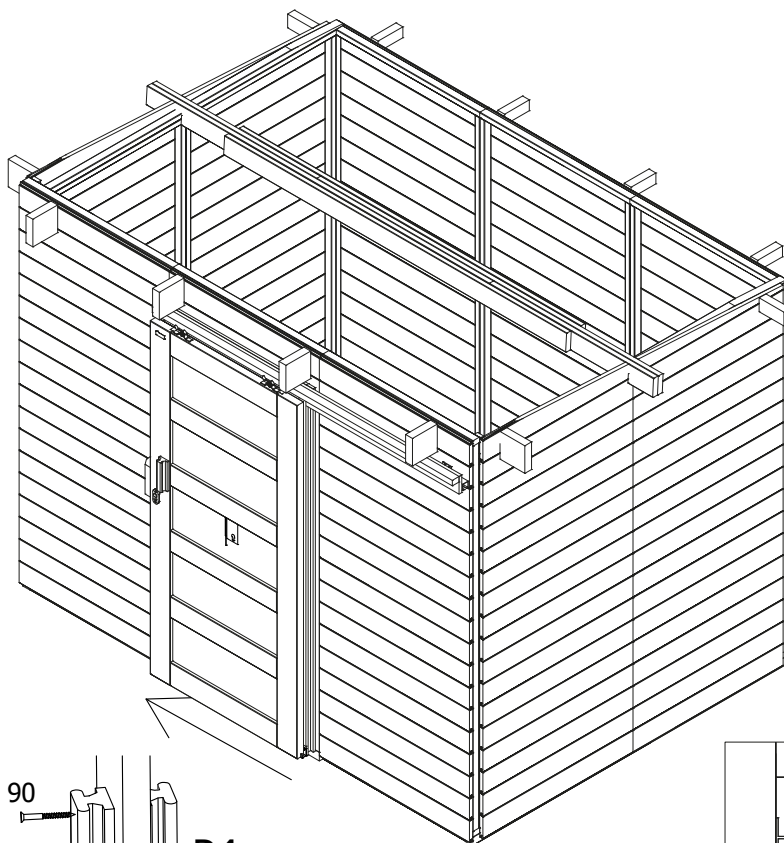
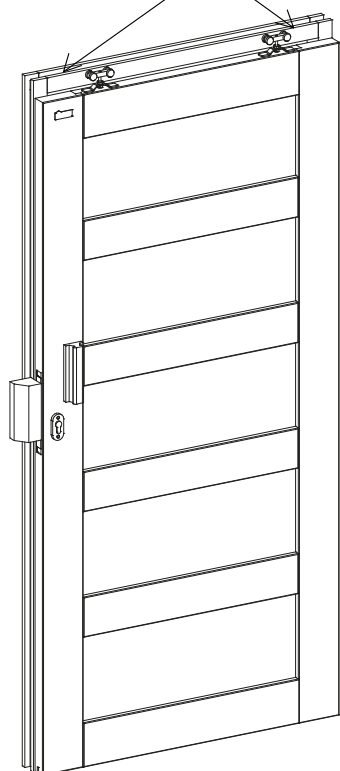

J = 34

7

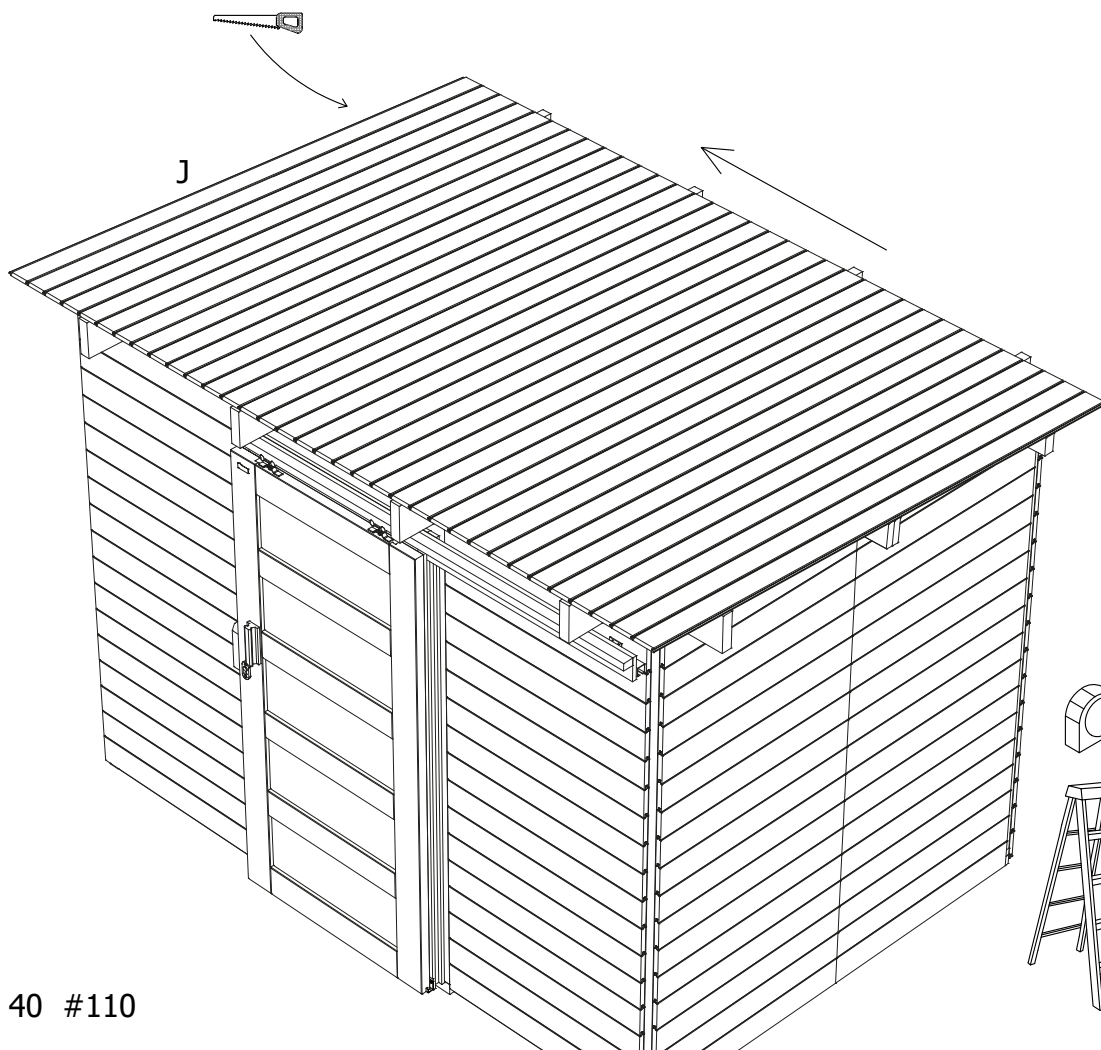

 2.5 x 40 #110

O = 3x3030

8

 2.5 x 16 #100

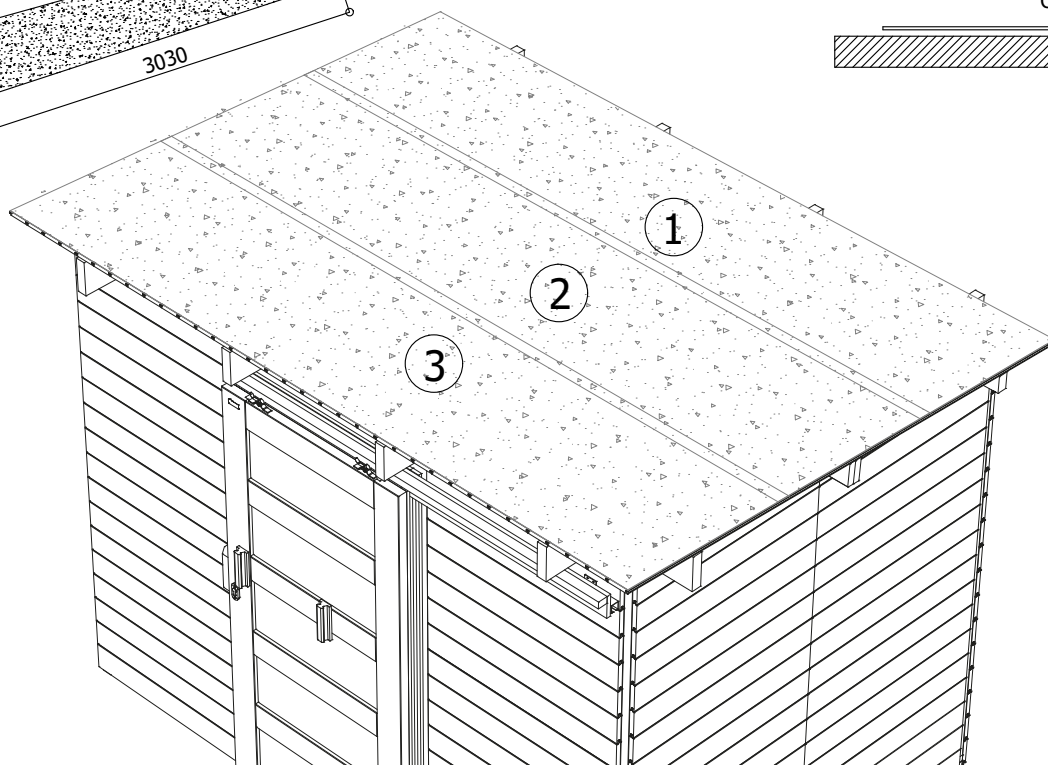
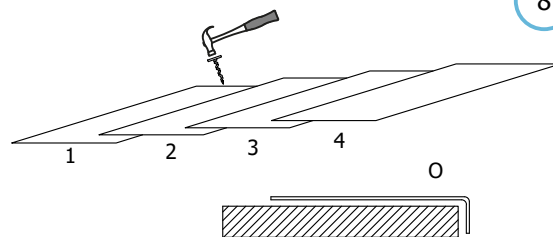
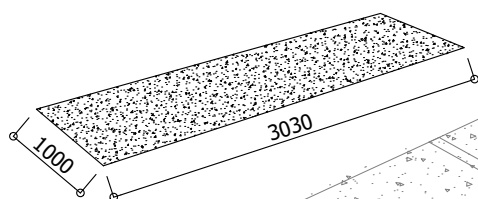

M = 4
M1 = 2
M2 = 2

9

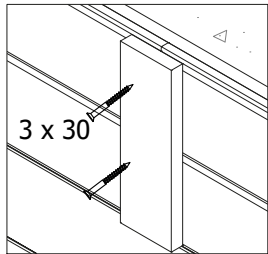
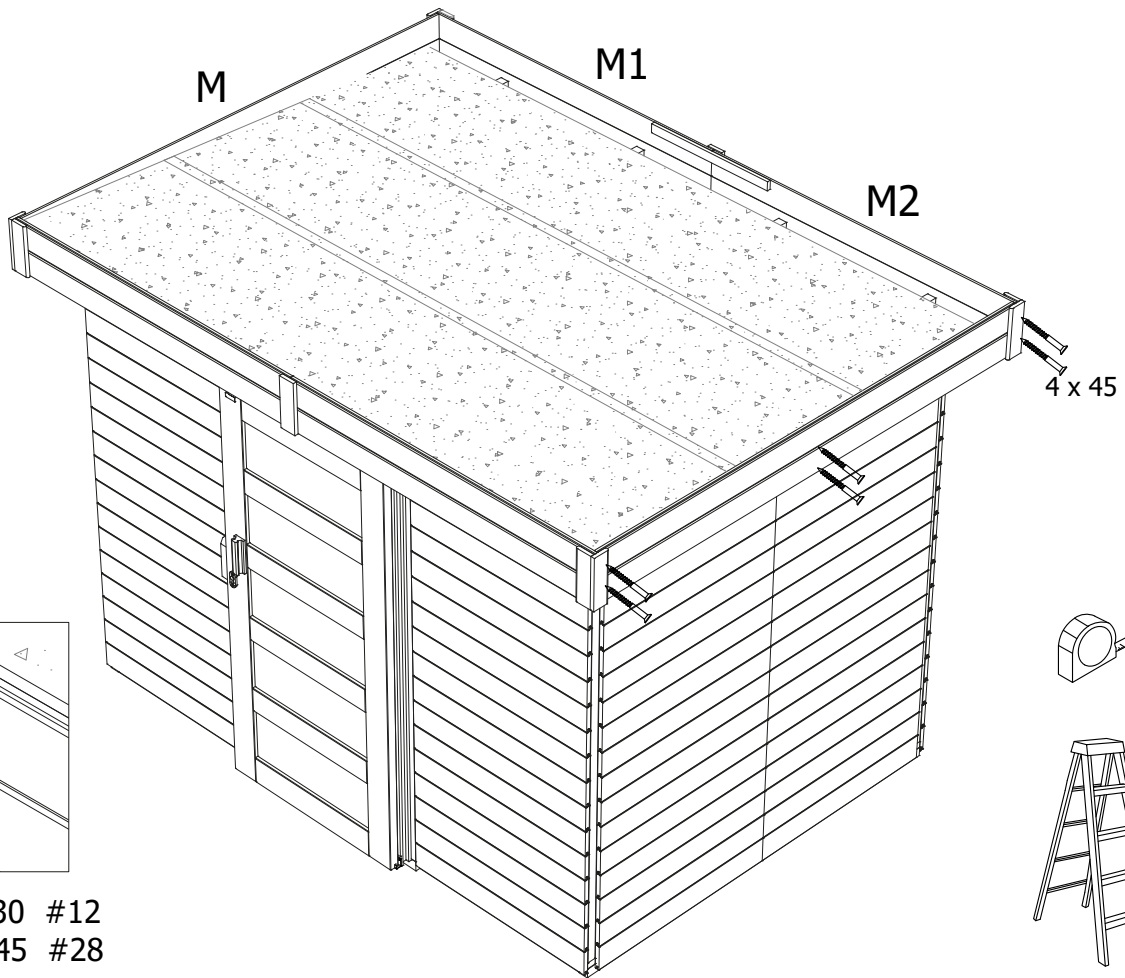

3 x 30 #12
 4 x 45 #28

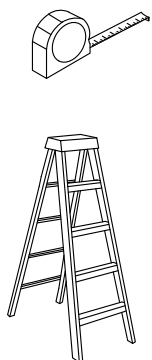

N = 2
N1 = 2
N2 = 1
L = 4

10

3 x 30 #34
 3 x 35 #32

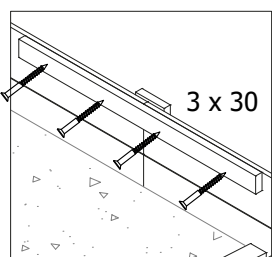
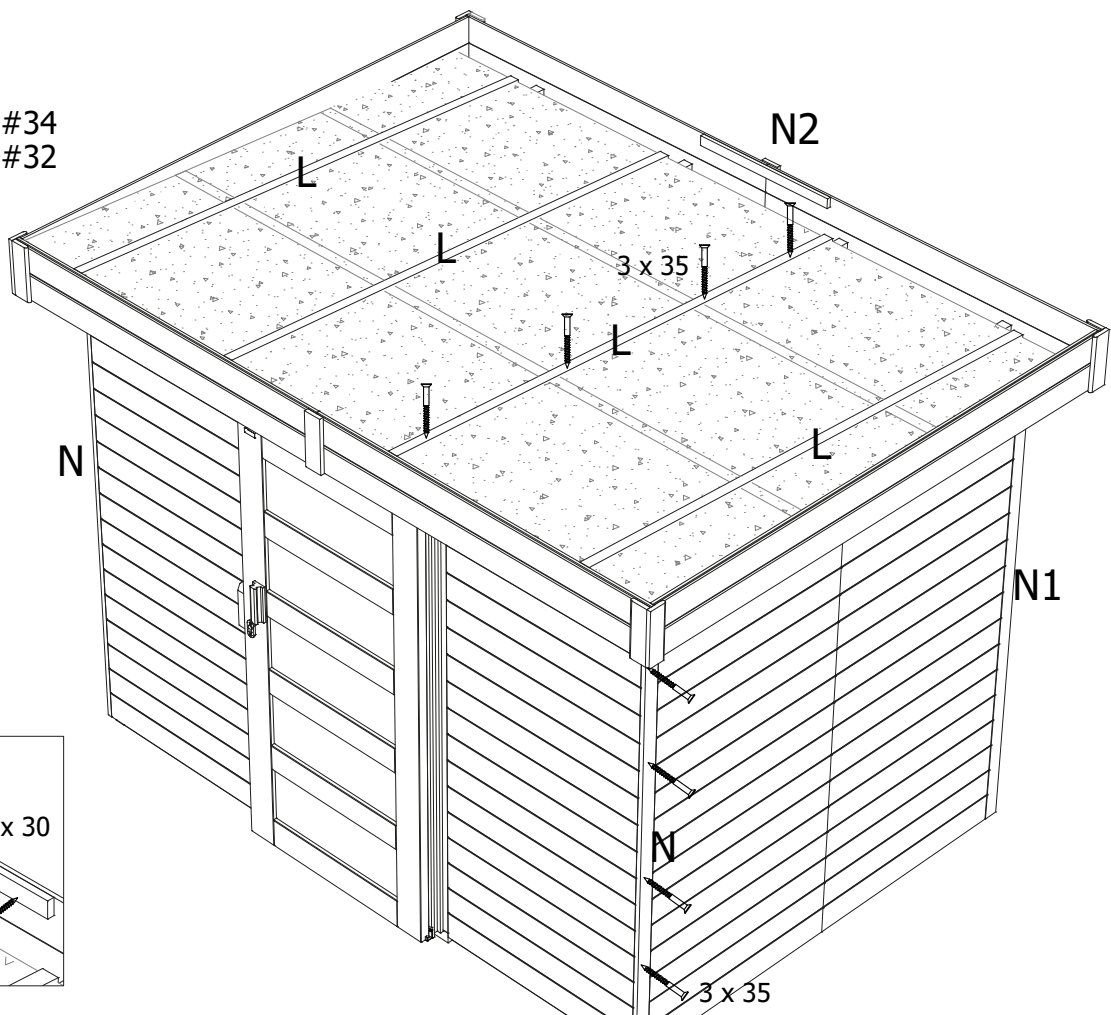

3 x 35