

Annecy

19-140-0057-0/S8471-1

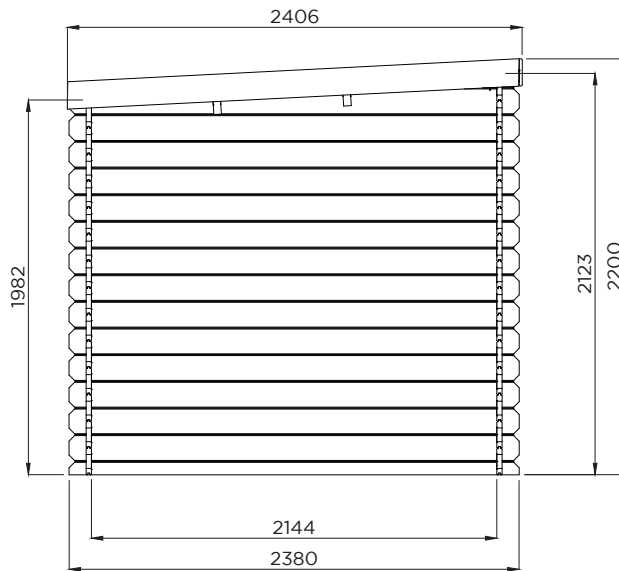

Deuropening / Embrasure de porte / Doorway : 1586
x
1757

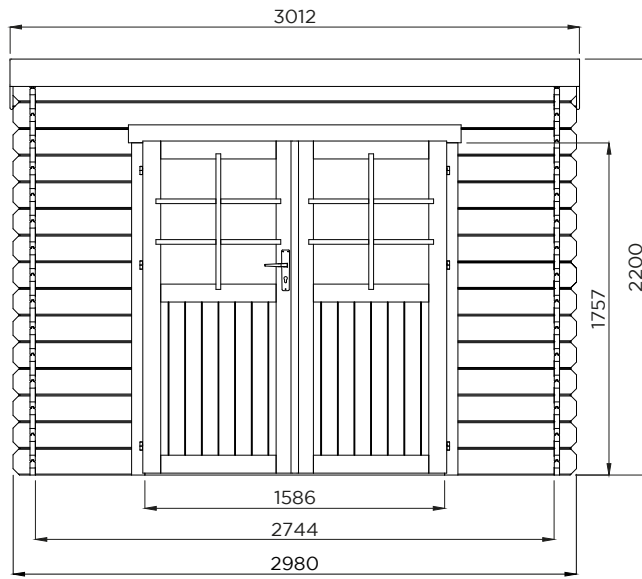

S8471-1

(NL) VOOR AANVANG VAN DE MONTAGE :

Bij ontvangst van het pakket dient u de geleverde stukken en hun aantallen te controleren aan de hand van de stuklijst om u ervan te vergewissen dat u alle stukken ontvangen hebt en dat die zich in goede staat bevinden. Het is sterk aan te raden niet met de montage te beginnen voor u deze controle hebt uitgevoerd en indien nodig de vervangstukken ontvangen hebt. Het is tevens verplicht het artikel op een betonplaat te monteren. Het is heel belangrijk te controleren dat alles waterpas gemonteerd werd en onder de correcte rechte hoek. Heel belangrijk is dat u het natuurlijke krimpen en uitzetten van het hout toelaat en de structuur niet blokkeert. (pas op met kasten, rekken, hangplanken, rails,...)

U heeft een geïmpregneerd artikel aangekocht en dit heeft enkele consequenties wat de montage betreft.

Door de opname van het beschermend product zullen alle onderdelen licht afwijkende afmetingen hebben en wij raden ten stelligste aan alles open te leggen om een zo goed mogelijke droging te bekomen alvorens de montage aan te zetten.

Verder is het niet abnormaal dat kleine openingen te zien zijn bij de montage, zowel boven de deur als bij de dakopbouw. Deze zullen na het natuurlijk drogen van het product verdwijnen, hou er evenwel rekening mee dat dit enkele weken kan duren.

(FR) AVANT LE MONTAGE :

A réception du colis, il convient de vérifier, par rapport à la nomenclature de l'abri que toutes les pièces figurent bien dans le colis et sont en bon état. Il est judicieux de ne commencer le montage effectif de l'abri qu'après avoir effectué cette vérification et éventuellement avoir reçu les pièces nécessaires au remplacement des pièces défectueuses. Il est impératif de monter l'article sur une dalle de béton. Il est très important de s'assurer de l'horizontalité de l'abri ainsi que de l'équerrage. Par ailleurs, il est impératif de ne pas fixer entre elles les planches constituant la structure de l'abri. (attention aux équerres, échagères, rails,...)

Vous avez acheté un article imprégné et cela a bien quelques conséquences en ce qui concerne le montage.

Par l'absorption du produit protégeant toutes les parties auront des mesures légèrement divergentes.

On conseille dès lors fortement d'exposer à l'air extérieur toutes les parties en visant un meilleur séchage avant de commencer le montage.

Puis il n'est pas anormal qu'il y ait des petits trous à voir lors du montage tant au-dessus de la porte qu'en montant le toit. Ceux-ci disparaîtront après le séchage naturel du produit. Tenez cependant compte que cela peut durer quelques semaines.

(GB) BEFORE THE ASSEMBLY :

When you receive the pack, please check if all the supplied pieces and their numbers comply with the parts list to make sure you have received all the pieces and that they are in good condition. It is strongly recommended not to start the installation before completing this check and if necessary, receiving the replacement parts. Furthermore, it is mandatory to install the product on a concrete slab, with a foil against rising damp underneath. The product must be installed level, fitted with the required drainage channels and at the correct right angle. It is very important that you allow the natural expansion and contraction of the wood and that you do not block the structure (watch out with cupboards, racks, hanging shelves, rails, etc.).

You have purchased an impregnated article, which has some implications regarding the assembly. Due to the absorption of the protective product, all parts will have slightly different dimensions and we strongly recommend to lay everything open in order let the parts dry as well as possible before starting the assembly.

Furthermore, it is not unusual that small openings are visible during the assembly, both above the door and in the roof. These will disappear after the natural drying of the product, keep in mind, however, that this may take several weeks.

(D) VOR ANFANG DES AUFBAUS :

Beim Erhalt des Pakets sind die gelieferten Teile sowie ihre Mengen anhand der Stückliste zu überprüfen, damit Sie sich davon überzeugen können, dass Sie sämtliche Teile erhalten haben, und dass diese einwandfrei sind. Es ist durchaus empfehlenswert, nicht mit dem Aufbau anzufangen ehe Sie dies überprüft und erforderlichenfalls die Ersatzteile erhalten haben. Es ist zudem fepflicht, den Artikel auf einer Betonplatte aufzustellen. Es ist aber sehr wichtig, zu überprüfen, dass die Gesamtheit waagrecht und im richtigen geraden Winkel aufgebaut wurde. Sehr wichtig ist, dass Sie das natürliche Schwinden und Quellen des Holzes erlauben und das Gefüge nicht sperren. (Bitte achten Sie auf Schränke, Regale, Hängebretter, Schienen, usw.)

Sie haben einen imprägnierten Artikel erworben, und dies hat einige Auswirkungen auf den Aufbau.



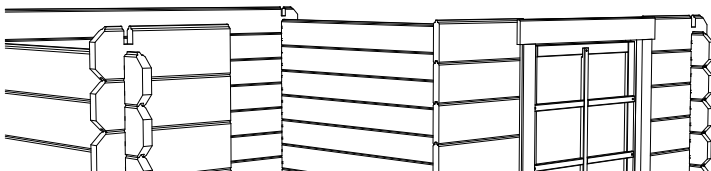
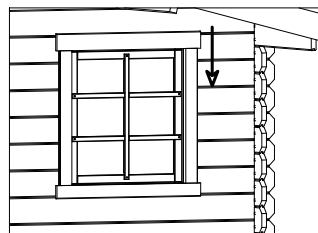
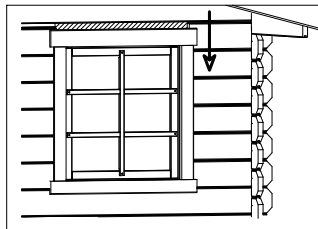
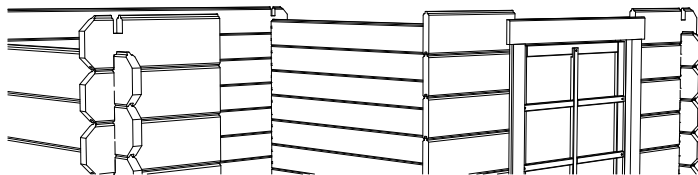

Wegen der Aufnahme des schützenden Produktes werden sämtliche Teile etwas abweichende Abmessungen aufweisen. Wir empfehlen daher unbedingt, das Ganze auszulegen, damit Sie eine möglichst gute Trocknung erreichen, ehe Sie mit dem Aufbau anfangen.

Weiterhin ist es nicht abnormaal, dass beim Aufbau, sowohl oberhalb der Tür als auch beim Dachaufbau kleine Öffnungen zu sehen sind. Nach der natürlichen Trocknung des Produktes werden diese verschwinden. Berücksichtigen Sie aber, dass dies einige Wochen in Anspruch nehmen kann.



Stuklijst / Liste des pièces / Bill of material

1

	Ref.	Index	#
	A	WW028X149-TPP-000-1-2380	2
	B	WW028x149-1IF-000-1-0650	26
	E	WW028x149-2IF-000-1-2380	26
	G	WW028x149-2IF-000-1-2980	16
	I	WW028x079-DEM-000-1-2380	2
	J	WW016x095-PLA-000-1-2350	35

ALTERNATIEF :

Het kan productiematig zijn dat er andere planchettes J in de verpakking zitten. De referentie is dan WW016x120-PLA-000-1-2350 => # 27 stuks

ALTERNATIVE :

Il peut être lié à la production que d'autres planchettes J soient incluses dans l'emballage. La référence est alors WW016x120-PLA-000-1-2350 => # 27 pièces



ALTERNATIVE :

It may be production-related that other planchettes J are included in the package. The reference is then WW016x120-PLA-000-1-2350 => # 27 pieces

ALTERNATIVE :

Es kann produktionsbedingt sein, dass andere Planchetten J im Paket enthalten sind. Die Referenz ist dann WW016x120-PLA-000-1-2350 => # 27 Stück

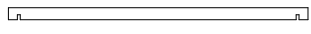
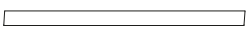
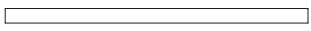
	K	WW040x120-PT0-000-1-2980	2
	M	WW016x145-VOL-086-1-2400	2
	M1	WW016x145-4R8-000-1-3012	1

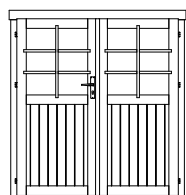

P	S8096C28-1	1
---	------------	---

- 1 x S8096-1
- 1 x WW012x040-2R8-000-1-1757
- 1 x RW020x060-4FA-000-1-1586
- 2 x S8095-T-1
- 1 x S618
- 2 x S5244 (glass 630mm x 690mm)
- 1 x S646 + 6 x S6201
- 1 x S673



R	S637	3
---	------	---

2.8 x 50 #100

PRINCIPE TPP

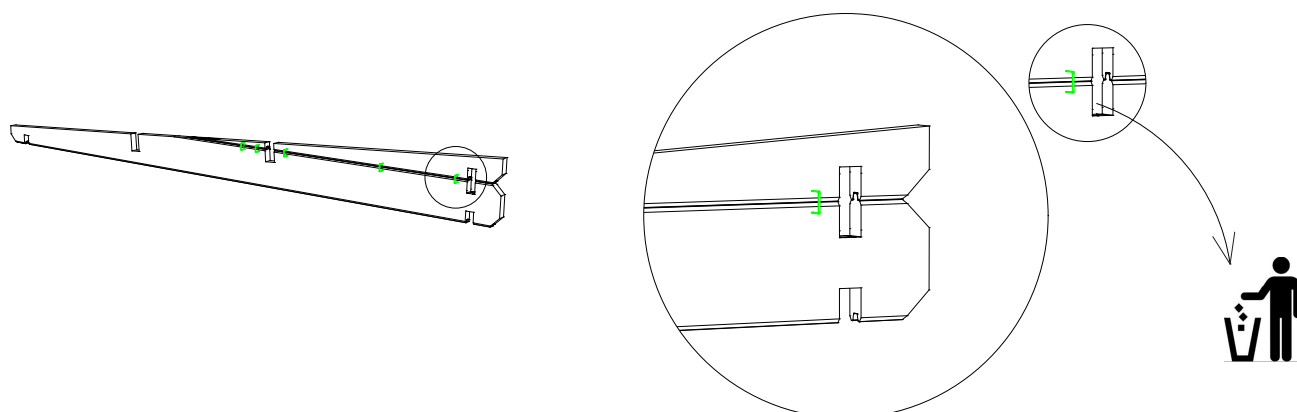

S8471-1

A = 2
B = 26
E = 26
G = 16
I = 2
K = 2

 2.8 x 50 # 12

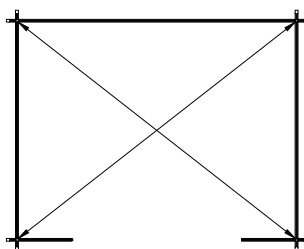
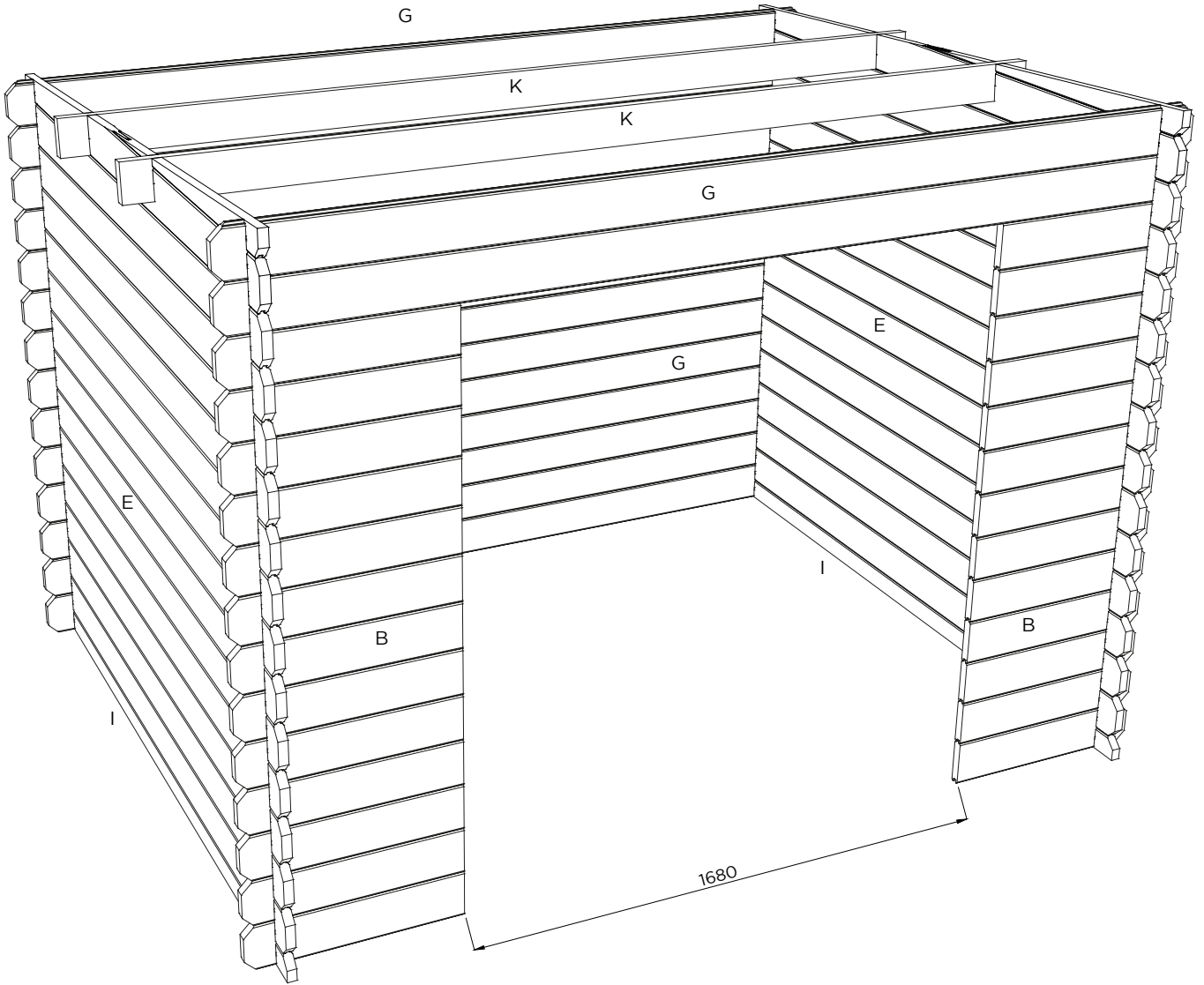

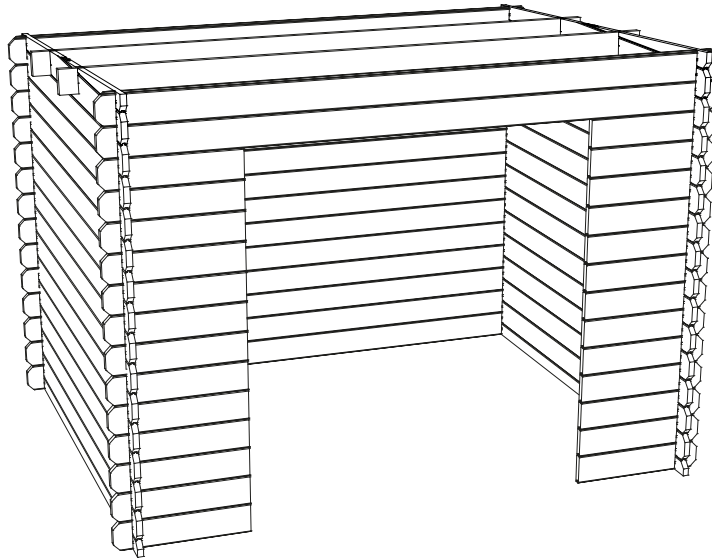

(NL) INFORMATIE :

Het is niet abnormaal dat kleine openingen te zien zijn bij de montage, zowel boven de deur als bij de dakopbouw. Deze zullen na het natuurlijk drogen van het product verdwijnen, hou er evenwel rekening mee dat dit enkele weken kan duren.

(FR) INFORMATION :

Il n'est pas anormal qu'il y ait des ouvertures à voir lors du montage tant au-dessus de la porte et les fenêtres qu'en montant le toit. Ceux-ci disparaîtront après le séchage naturel du produit. Tenez cependant compte que cela peut durer quelques semaines.

(GB) INFORMATION :

It is not unusual that small openings are visible during the assembly, both above the door and in the roof. These will disappear after the natural drying of the product, keep in mind, however, that this may take several weeks.

(D) INFORMATION :

Es ist nicht abnormal, dass beim Aufbau, sowohl oberhalb der Tür als auch beim Dachaufbau kleine Öffnungen zu sehen sind. Nach der natürlichen Trocknung des Produktes werden diese verschwinden. Berücksichtigen Sie aber, dass dies einige Wochen in Anspruch nehmen kann.

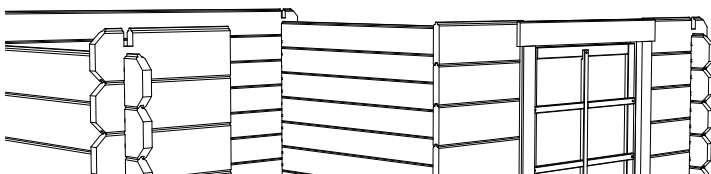
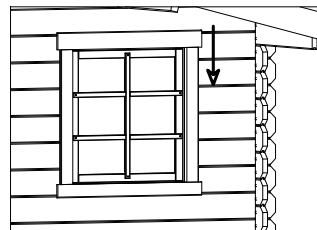
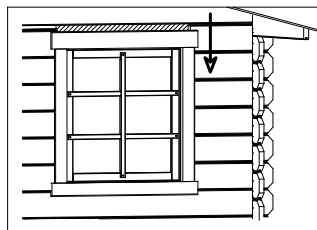
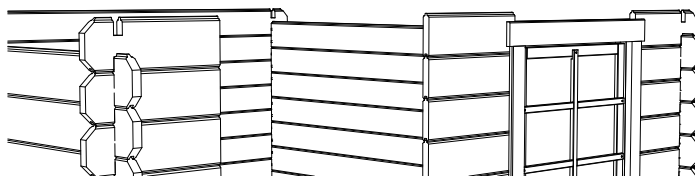

S8471-1

J = 35 of/ou/or/oder 27

 2.8 x 50 # 140

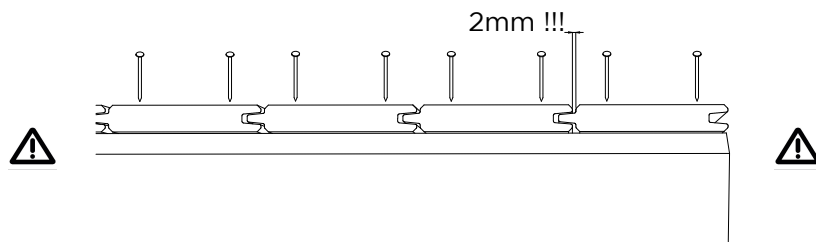
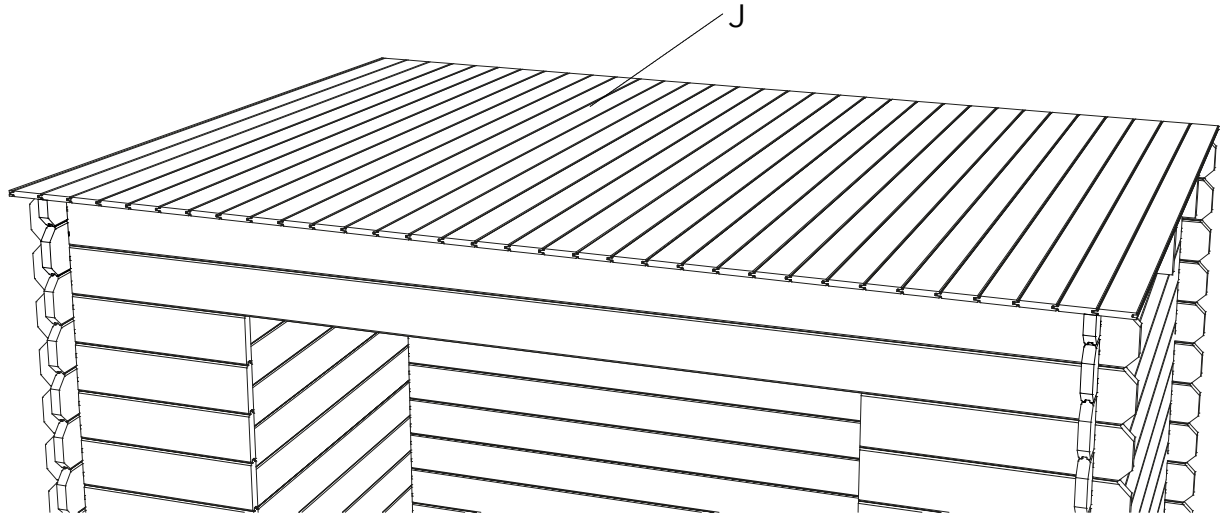

M = 2

M1 = 1

 2.8 x 50 # 20

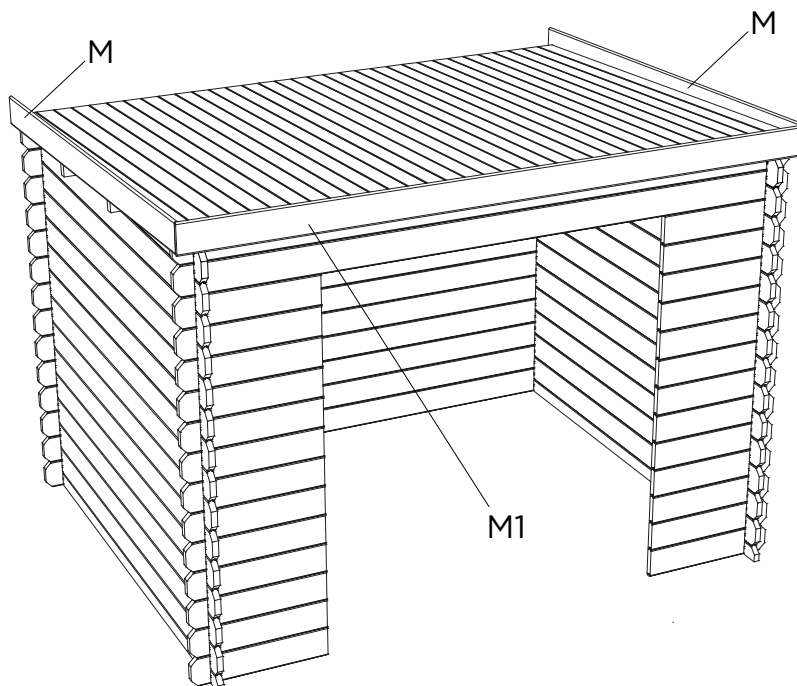

S8096C28-1

1

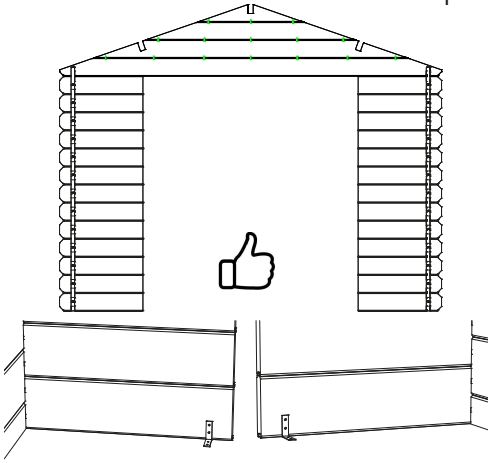

2

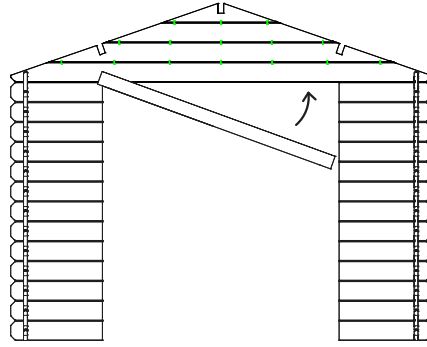

3

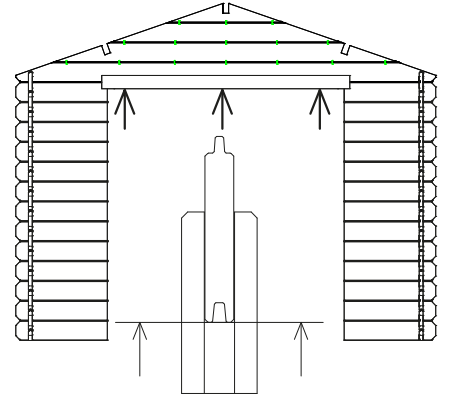

4

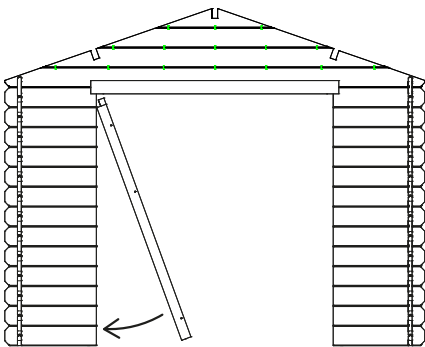

5

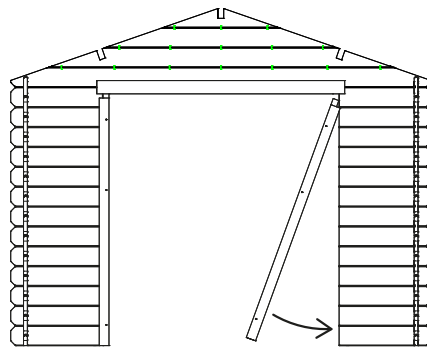

6

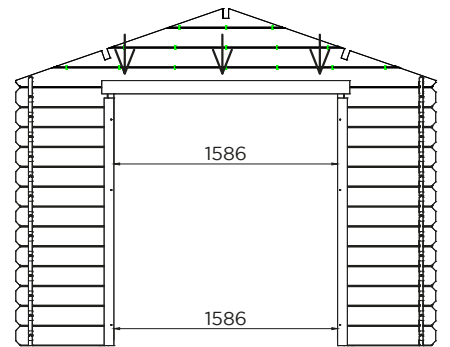

7

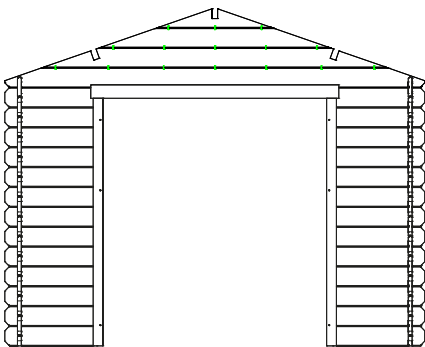

8

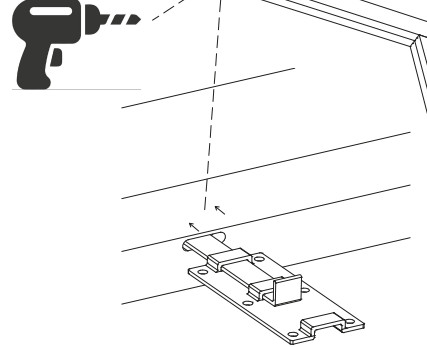

9

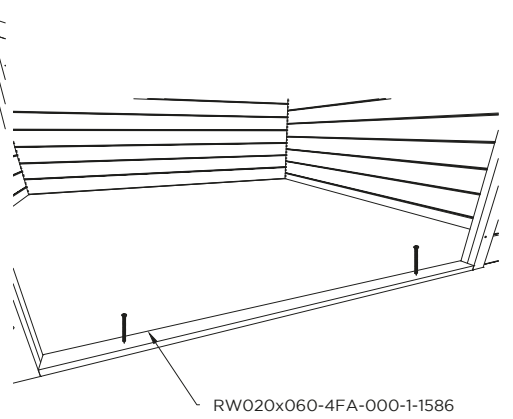

10

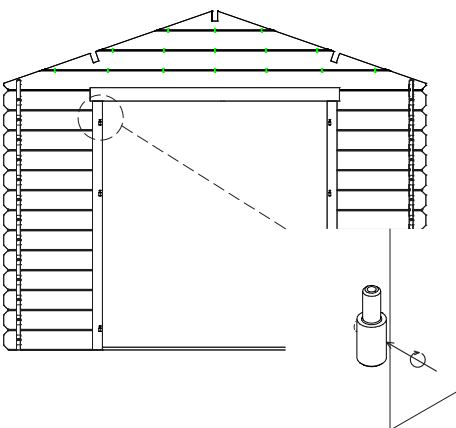

11

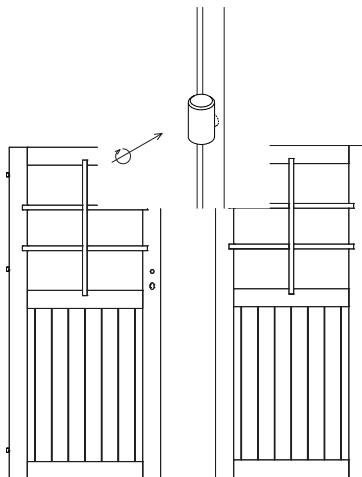

12

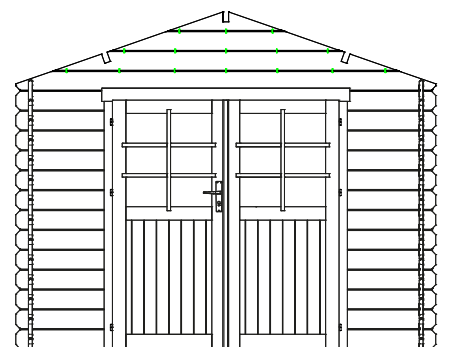

S8096C28-1

