

3432 M/70

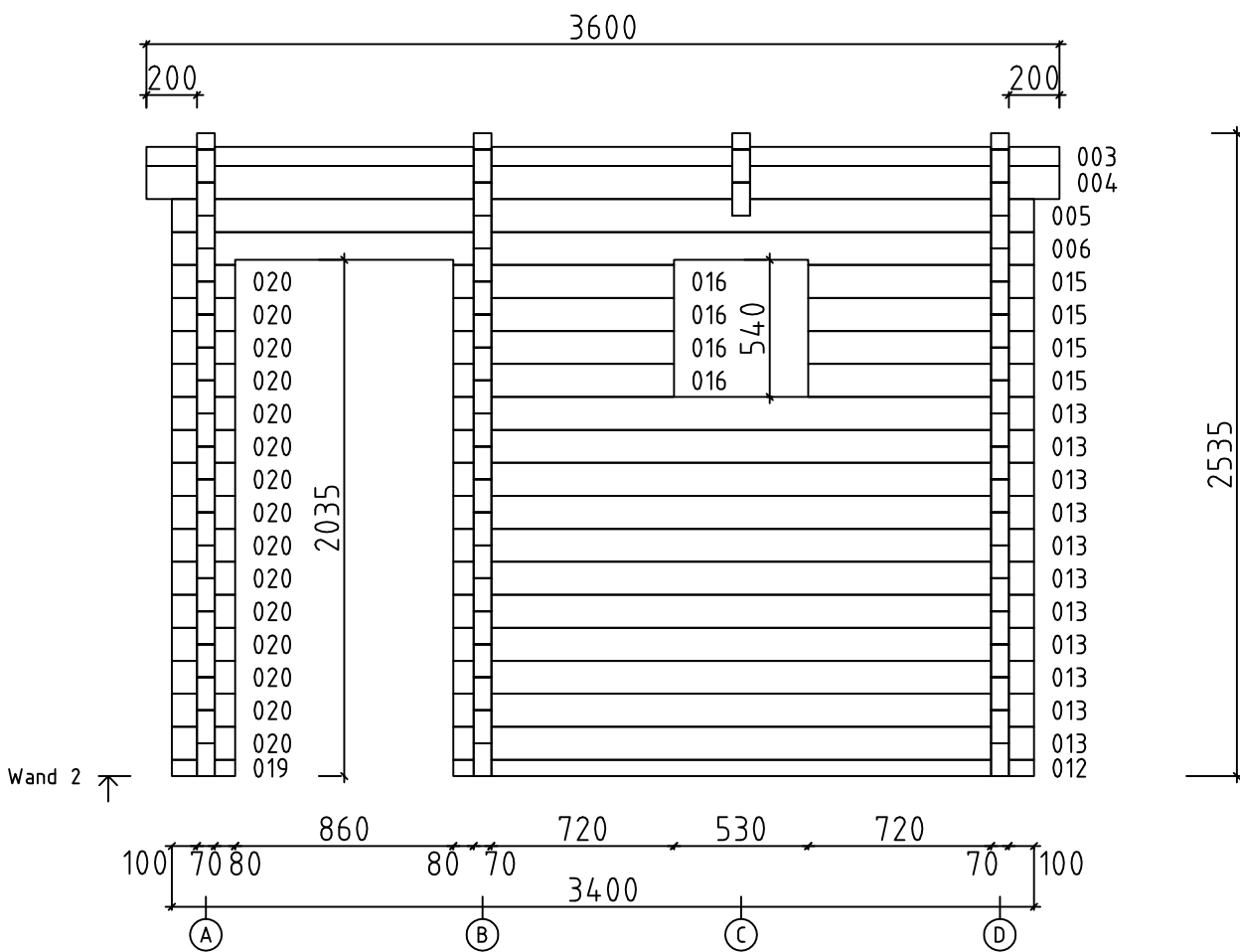

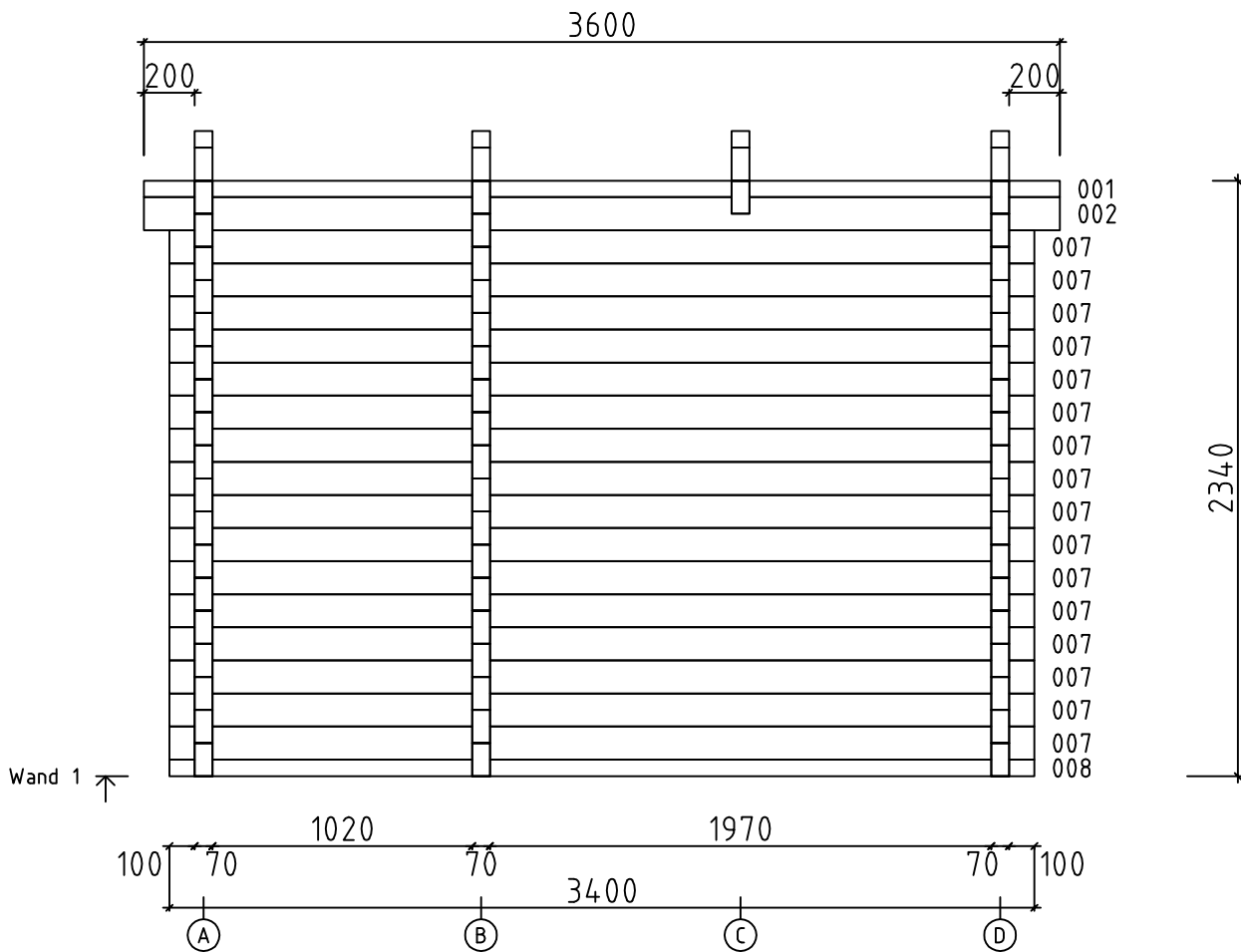

3432 M/70

Wände

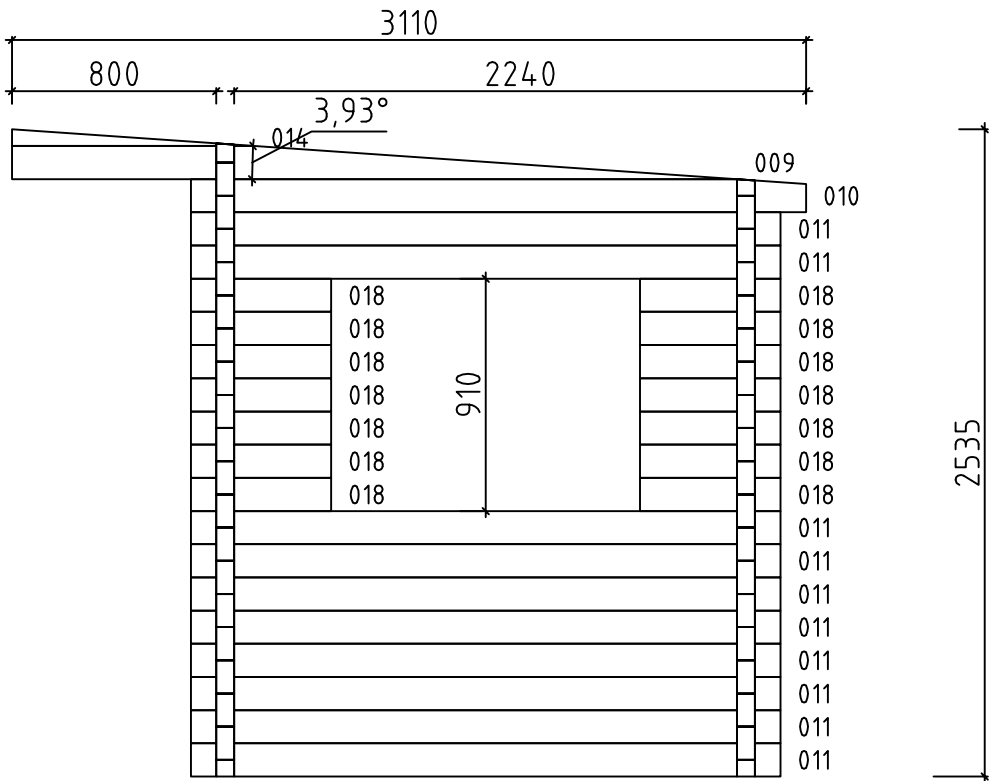

Wand A ↗

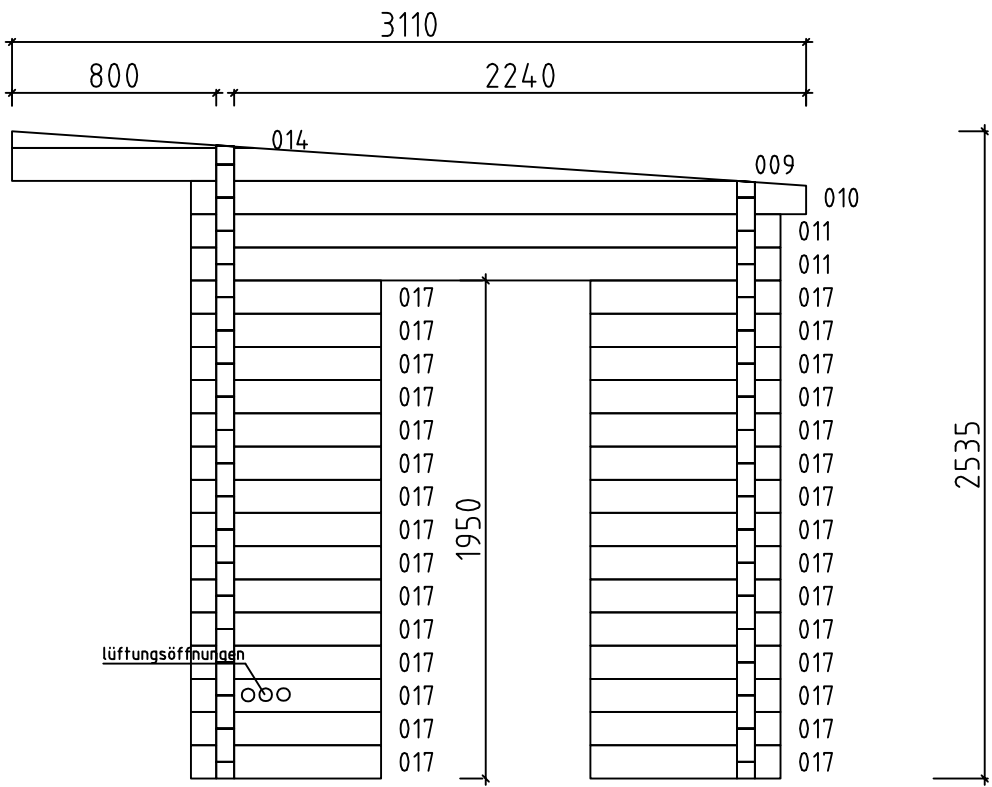
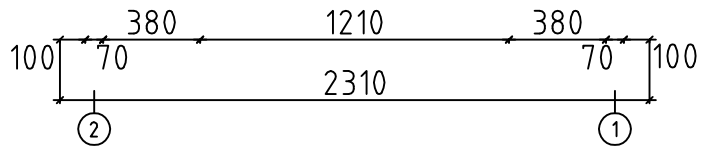

Wand B ↗

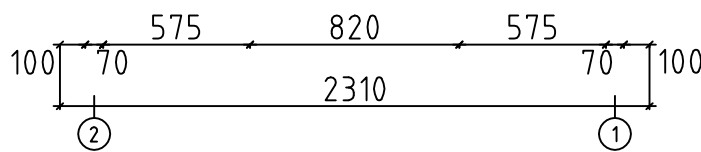

3432 M/70

Wände

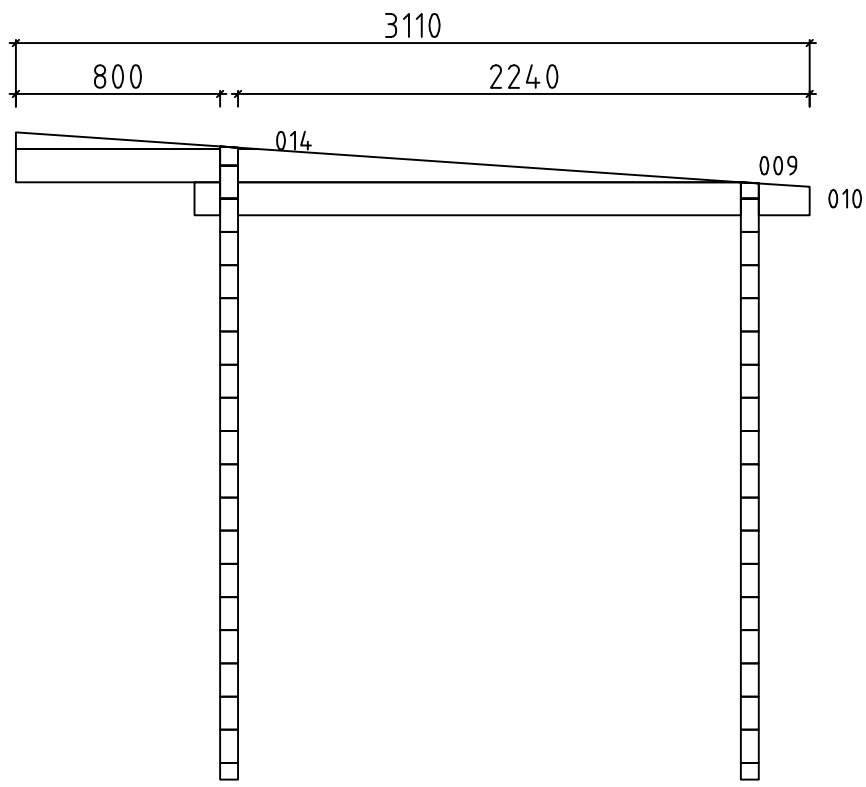

Wand C ↗

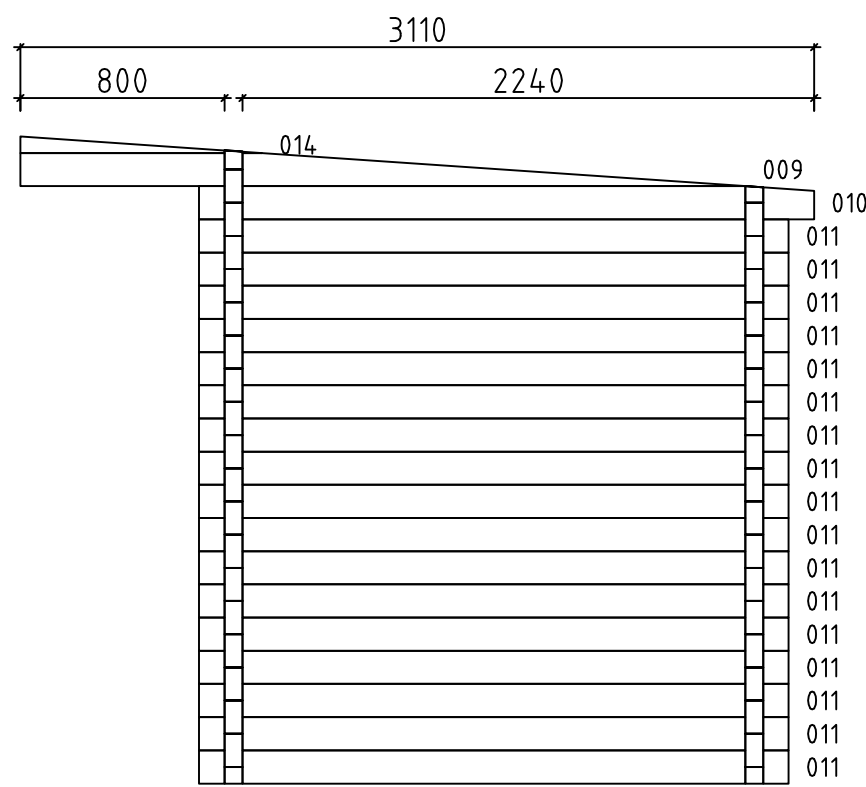
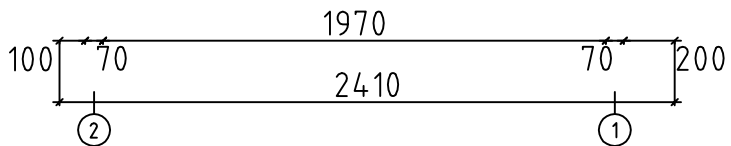



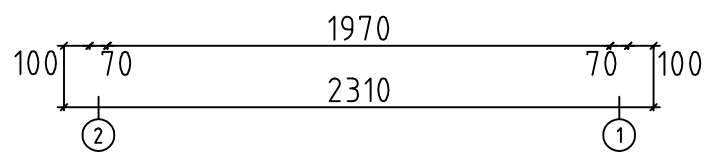





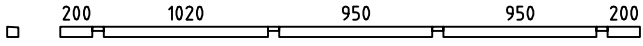
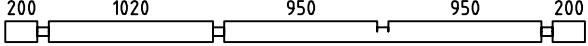
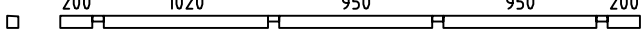
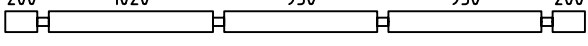
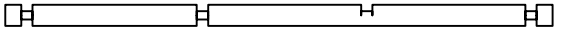
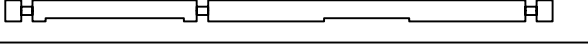
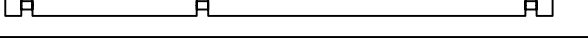
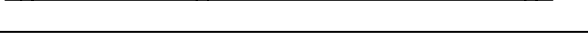
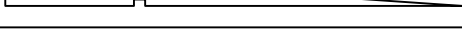
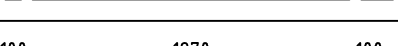
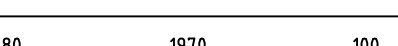
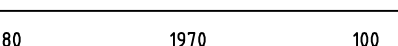

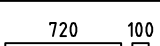
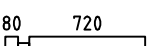
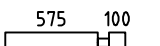



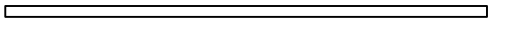
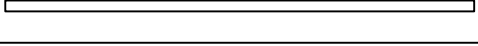
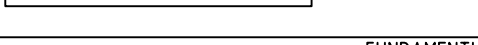
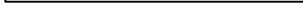

Wand D ↗

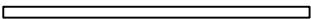
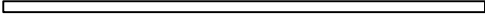
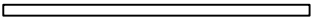

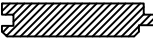
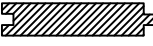
3432 M/70

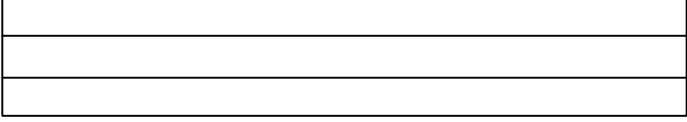
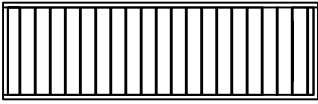
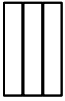
Wände

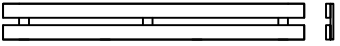
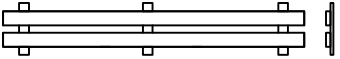
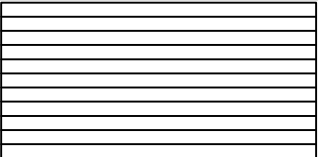
Pos	Teilleiste 3432 M/70	Stck	Profil (mm)	Länge (mm)
001		1	70x65	3600
002		1	70x130	3600
003		1	70x75	3600
004		1	70x130	3600
005		1	70x130	3400
006		1	70x130	3400
007		16	70x130	3400
008		1	70x65	3400
009		4	70x130	2840
010		4	70x130	2410
011		29	70x130	2310
012		1	70x65	2290
013		11	70x130	2290
014		4	70x65	947
015		4	70x130	890
016		4	70x130	870
017		29+1	70x130	745
018		14	70x130	550
019		1	70x65	250
020		15	70x130	250
FH2	FUNDAMENTHÖLZER 	2	94x68	3180
FH5	FUNDAMENTHÖLZER 	1	94x68	2992
FH8	FUNDAMENTHÖLZER 	2	94x68	2912
FH1	FUNDAMENTHÖLZER 	1	94x68	1902
FH7	FUNDAMENTHÖLZER 	1	68x68	2992

Pos	Teileliste 3432 M/70		Stck	Profil (mm)	Länge (mm)
FH4	FUNDAMENTHÖLZER 		3	68x68	1902
FH6	FUNDAMENTHÖLZER 		1	44x68	2992
FH3	FUNDAMENTHÖLZER 		1	44x68	1902
LE1	LEISTE	UNTER AUSSENTÜR	1	60x18	860
	TERRASSENBRETT		26	120x28	1000
	FUSSBODENBRETT		23 18	88x19 113x19	1965
	FUSSBODENBRETT		23 18	88x19 113x19	1015
	DACHBRETT		36 28	88x19 113x19	3600
	ABDECKLEISTEN			15x28	35,0
	DACHPAPPENFIXIERUNG			40x18	14,0
	DACHBLENDEN		2 2		3110 3636
	FENSTER 510x510		1		
	FENSTER 1190x880		1		
	TÜR 840x1980	/DIN links/	1		
	TÜR 800x1920	/DIN links/	1		
	SAUNABANK /Aspen/ 60 cm/50cm		2 1	ca 600x90 ca 500x90	1955 1355
	KOPFSTÜTZE /Aspen/	 	2	ca 444x300	
	RÜCKLEHNE /Aspen/		2	ca 250x39	1860
	BÄNKE ZWISCHENSTÜCK /Aspen/		1	ca 350x39	1955
	DECKENISOLATION	 	2 Elemente	ca 1950x975	

