

# Aussensauna 3940m<sup>2</sup>/70

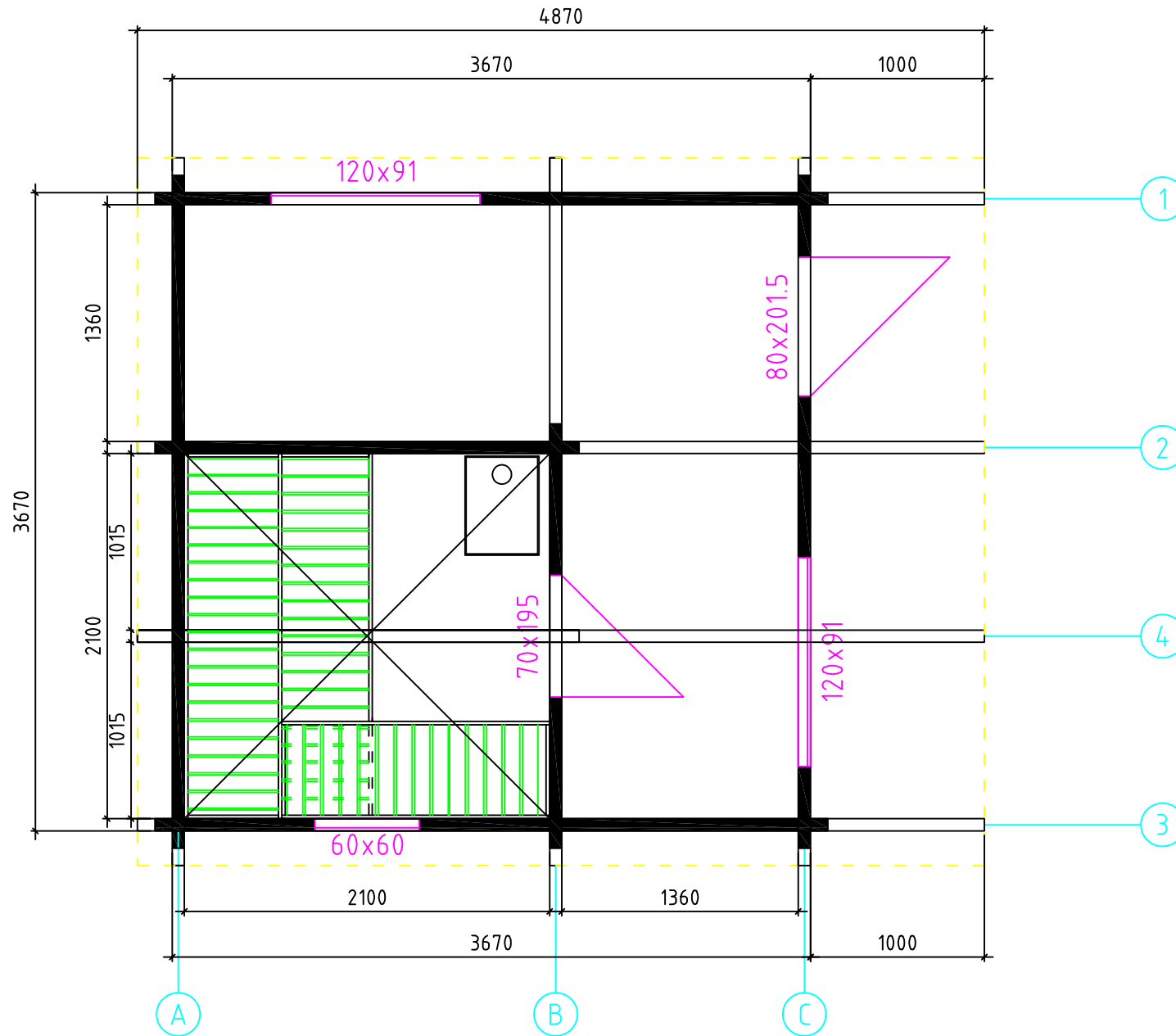

Grundplan

# Aussensauna 3940m/70

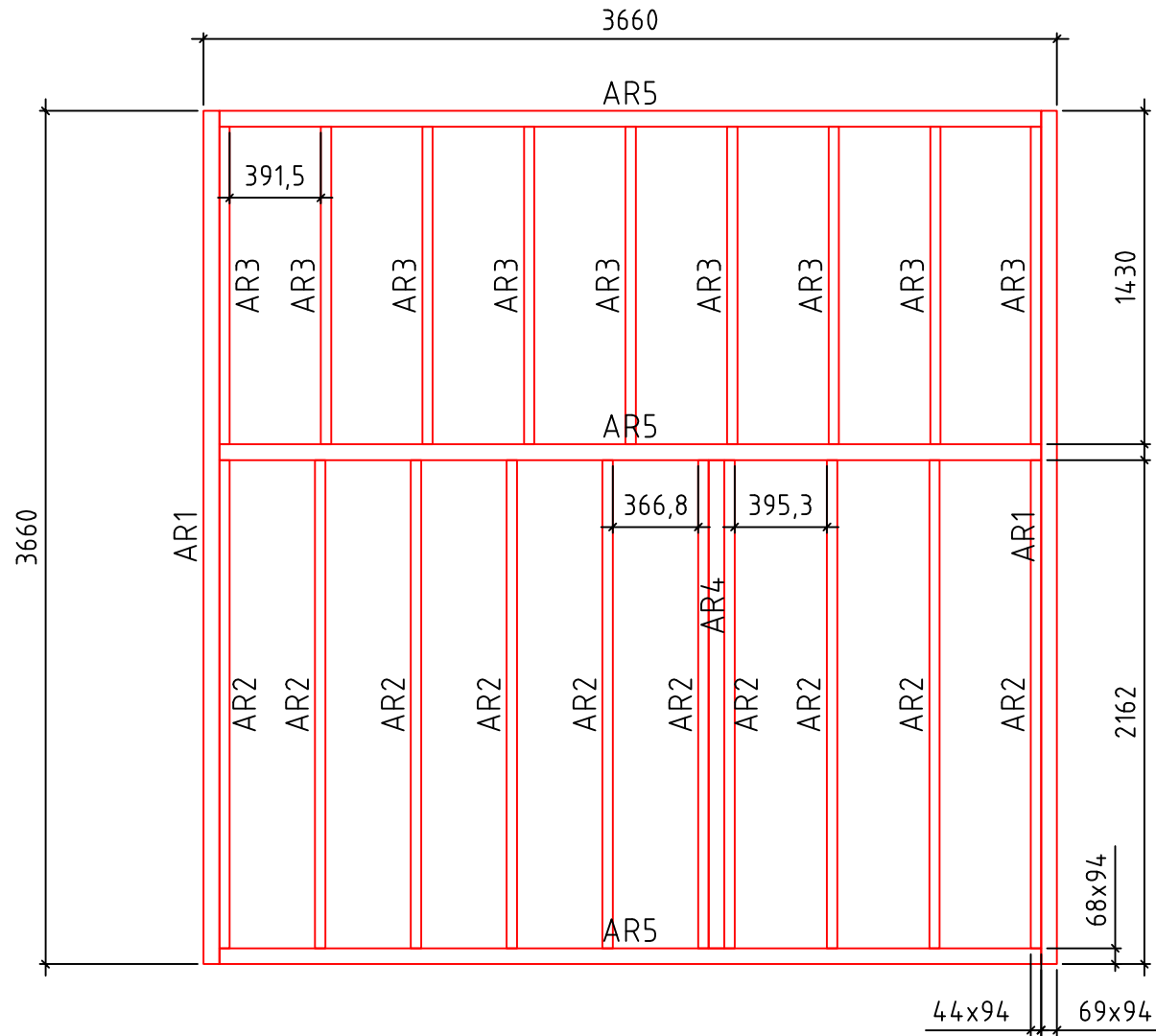

Fundament

# Aussensauna 3940m/70

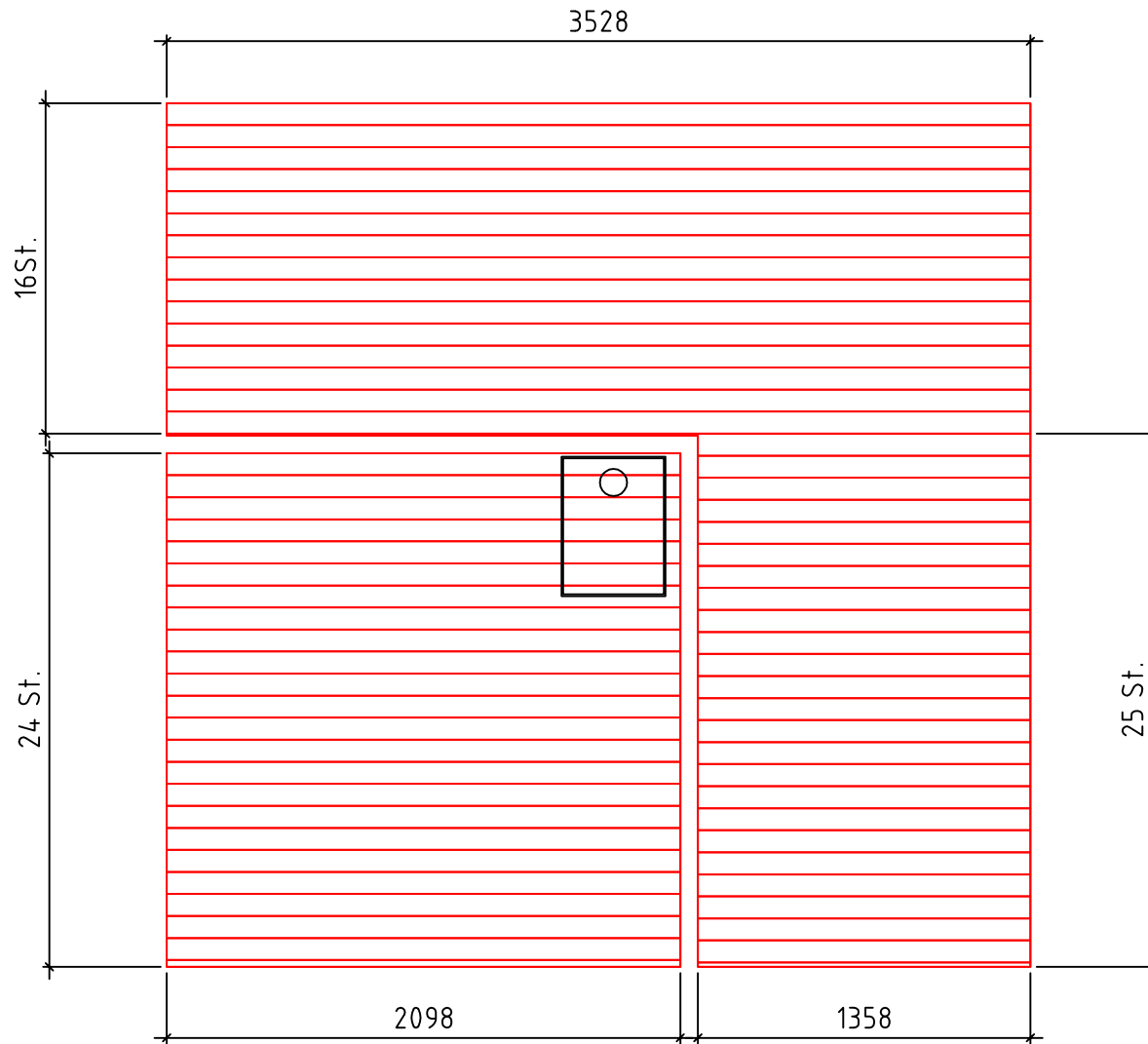

Fussboden

# Aussensauna 3940m/70

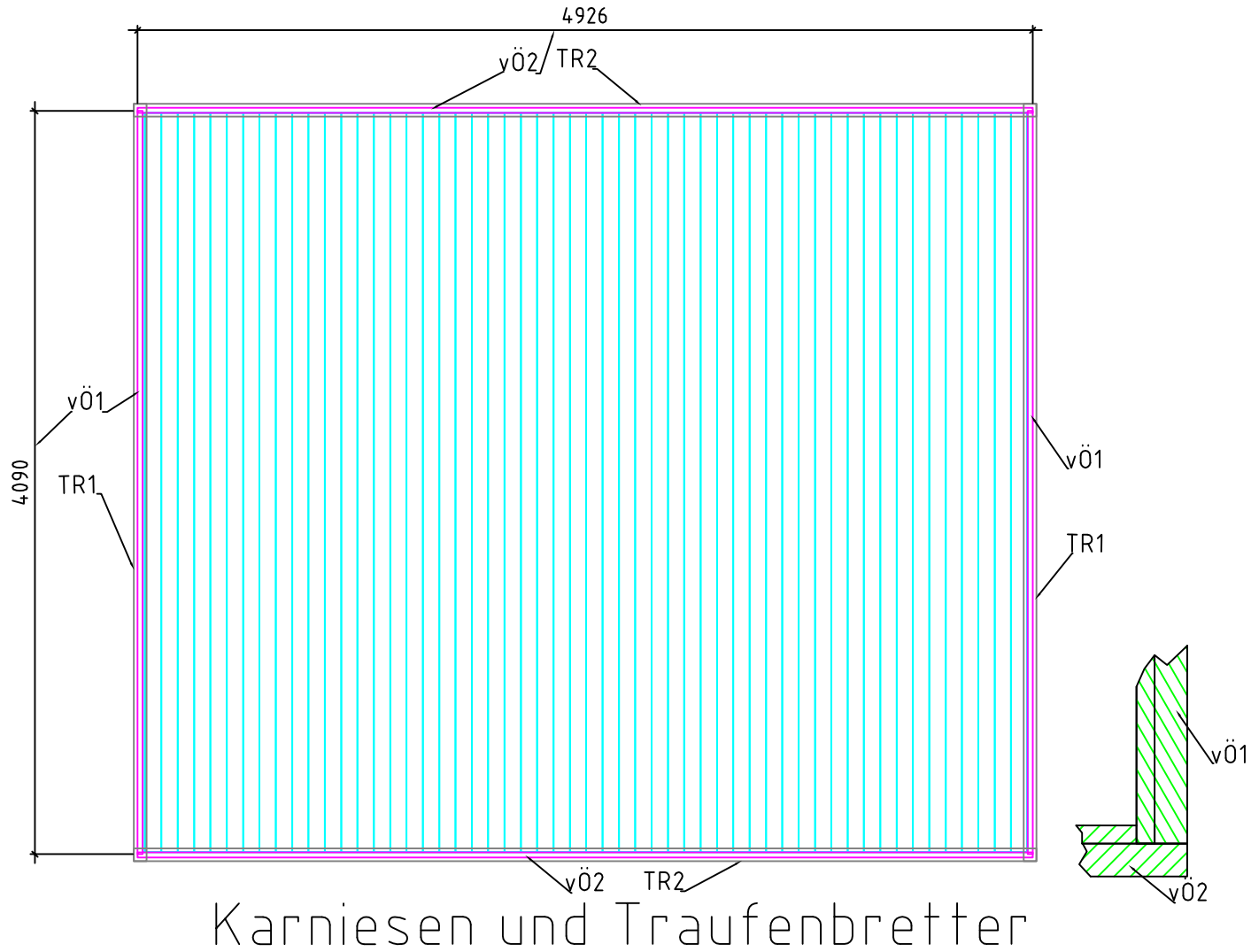

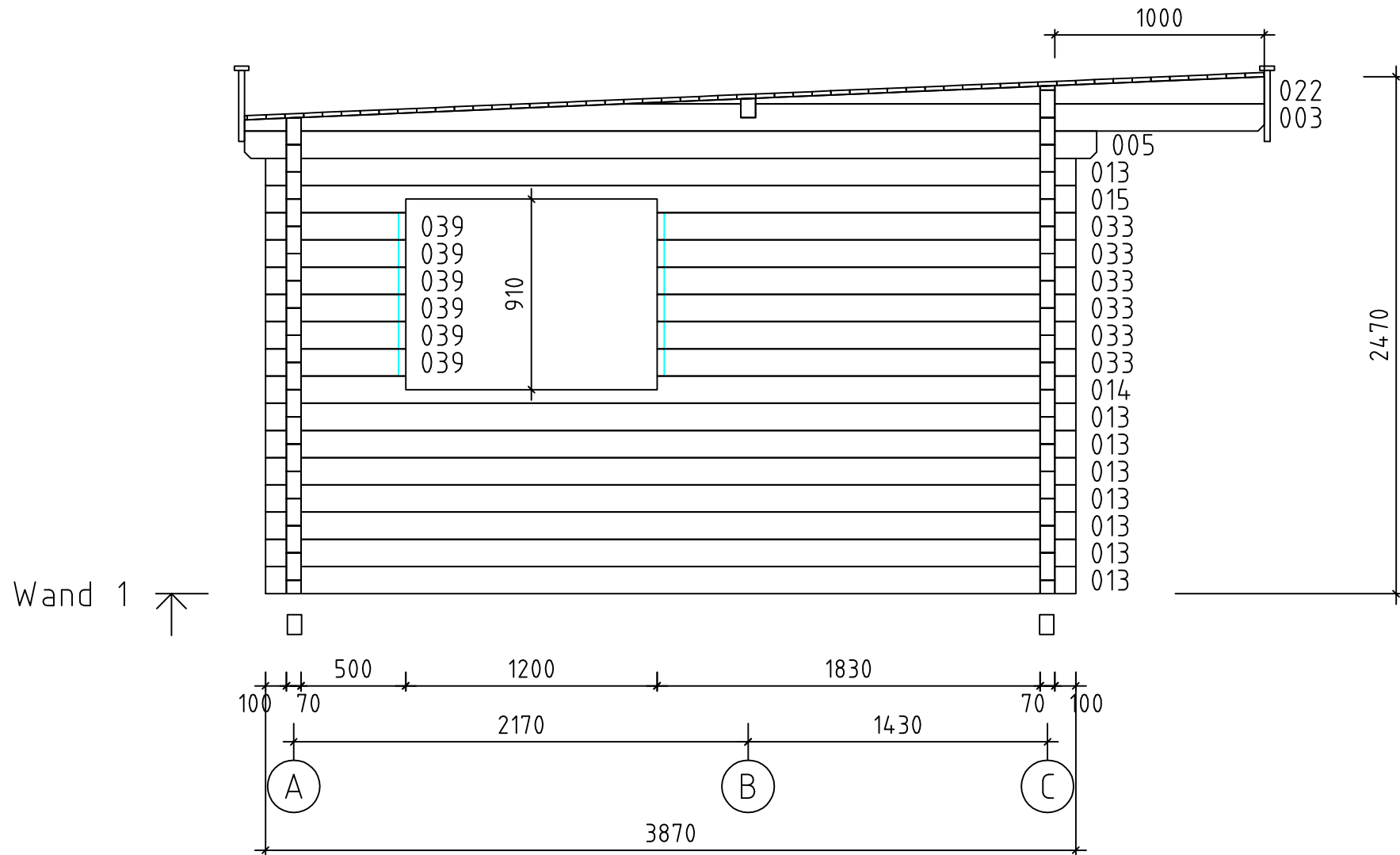

Aussensauna 3940m/70



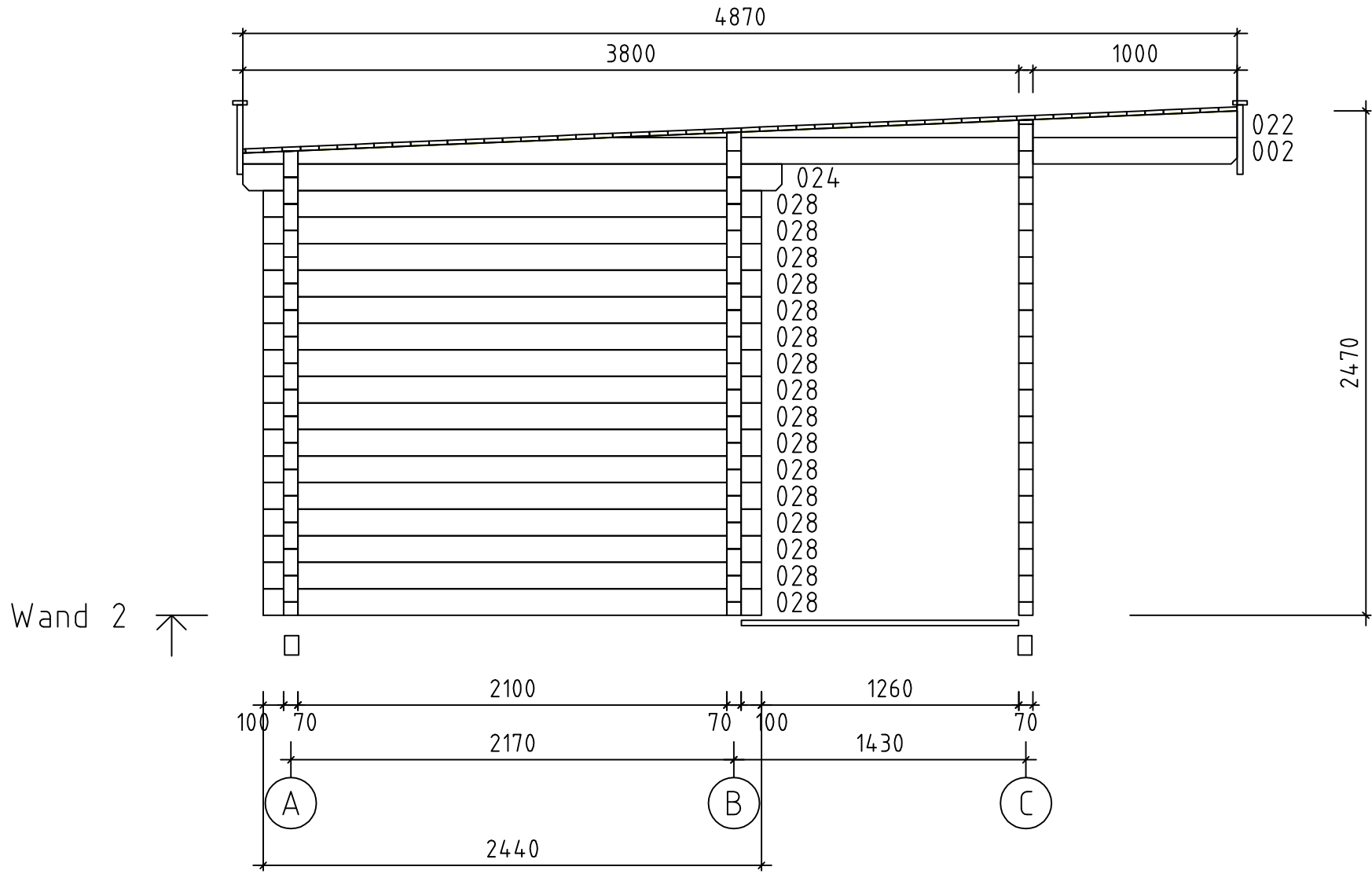

Aussensauna 3940m/70

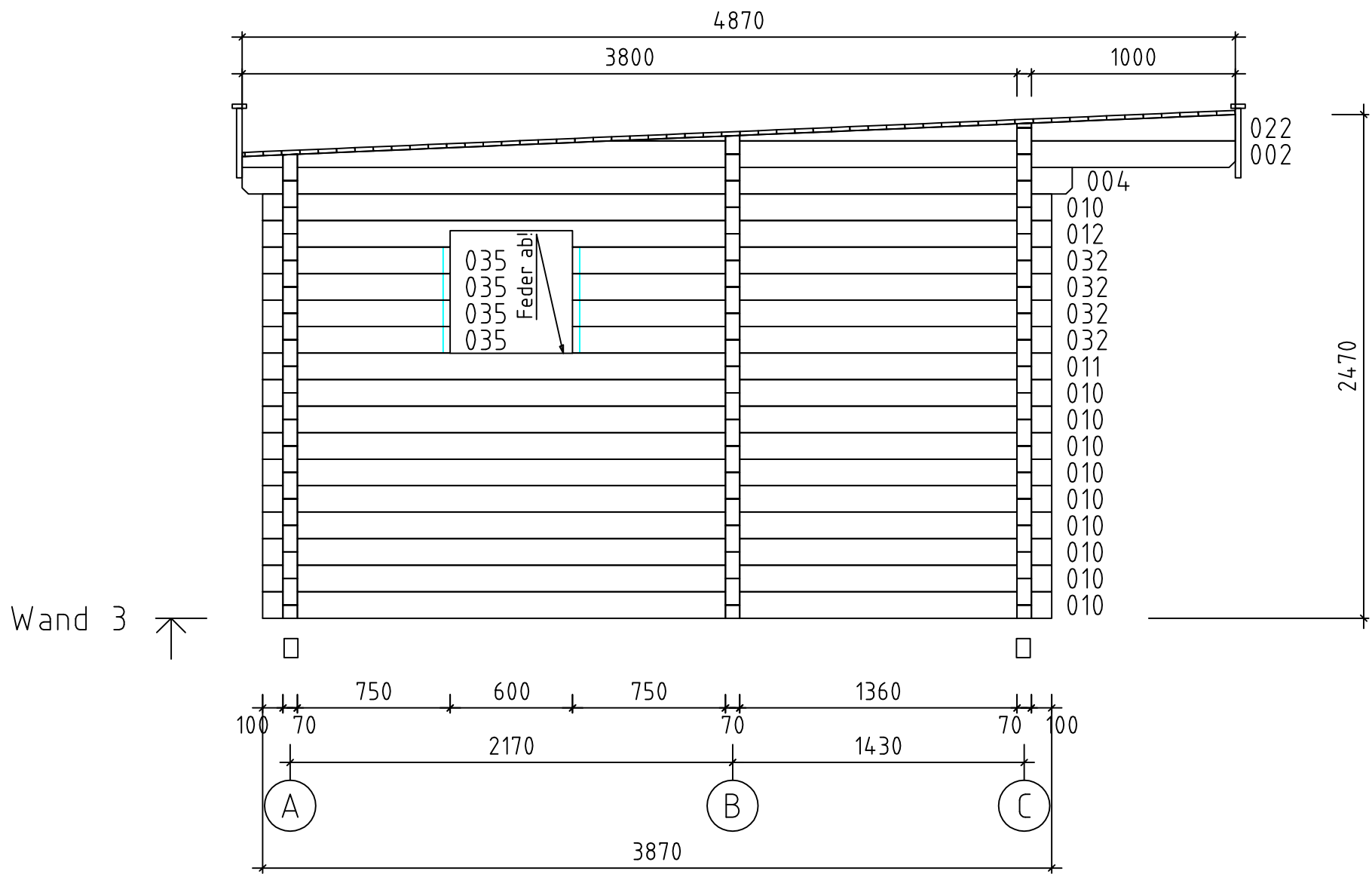

Wand 3 ↑

Aussensauna 3940m/70

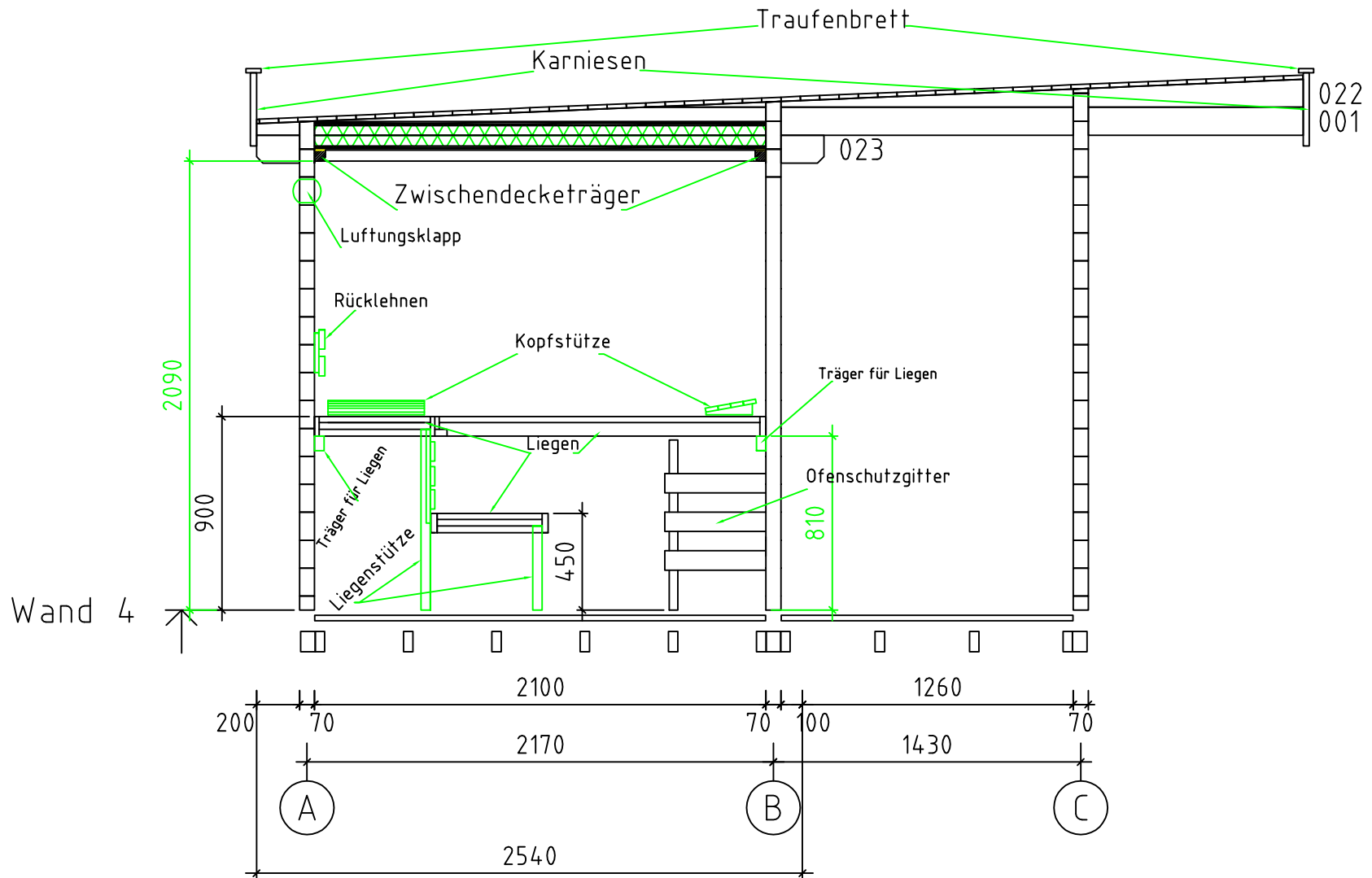

Aussensauna 3940m/70

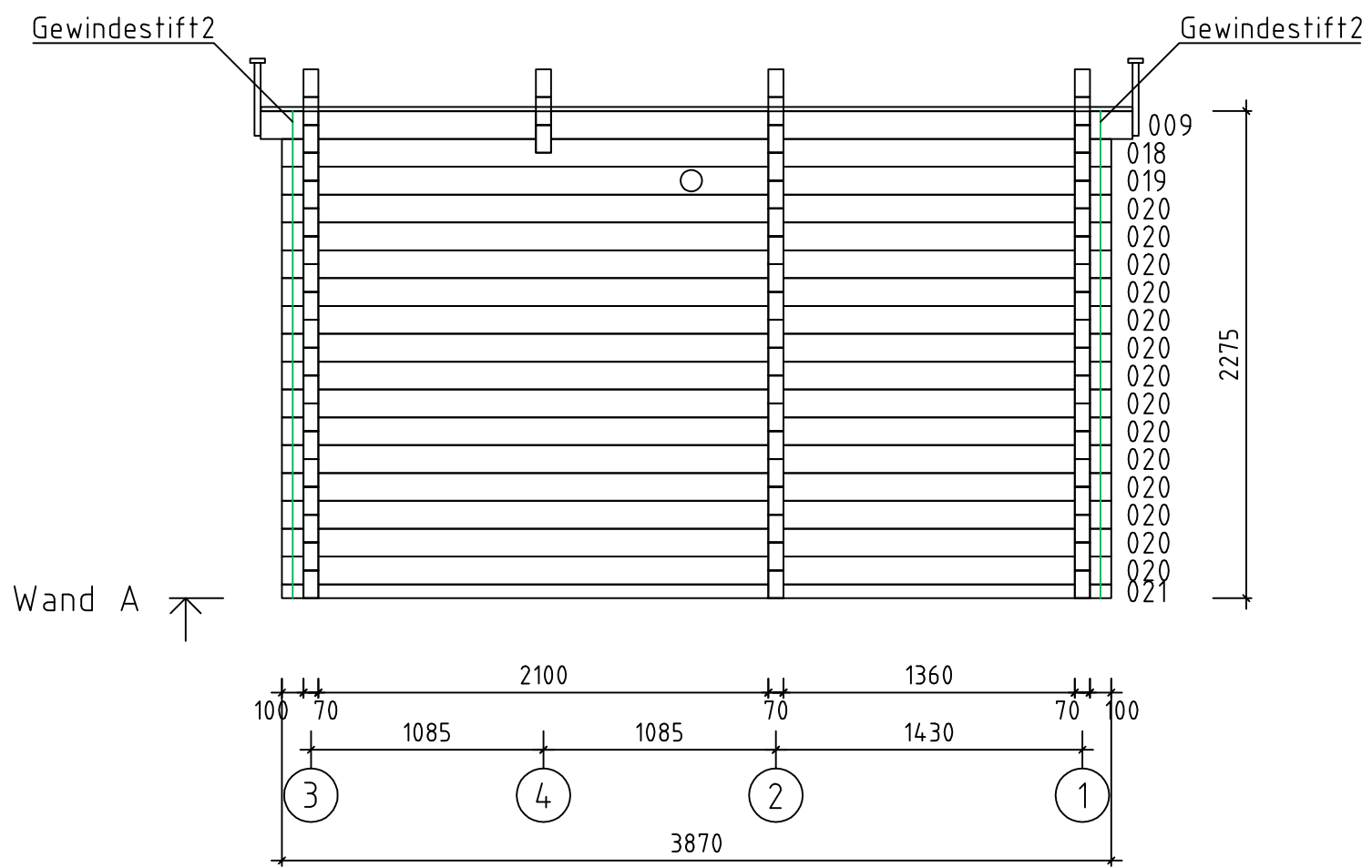

Aussensauna 3940m/70

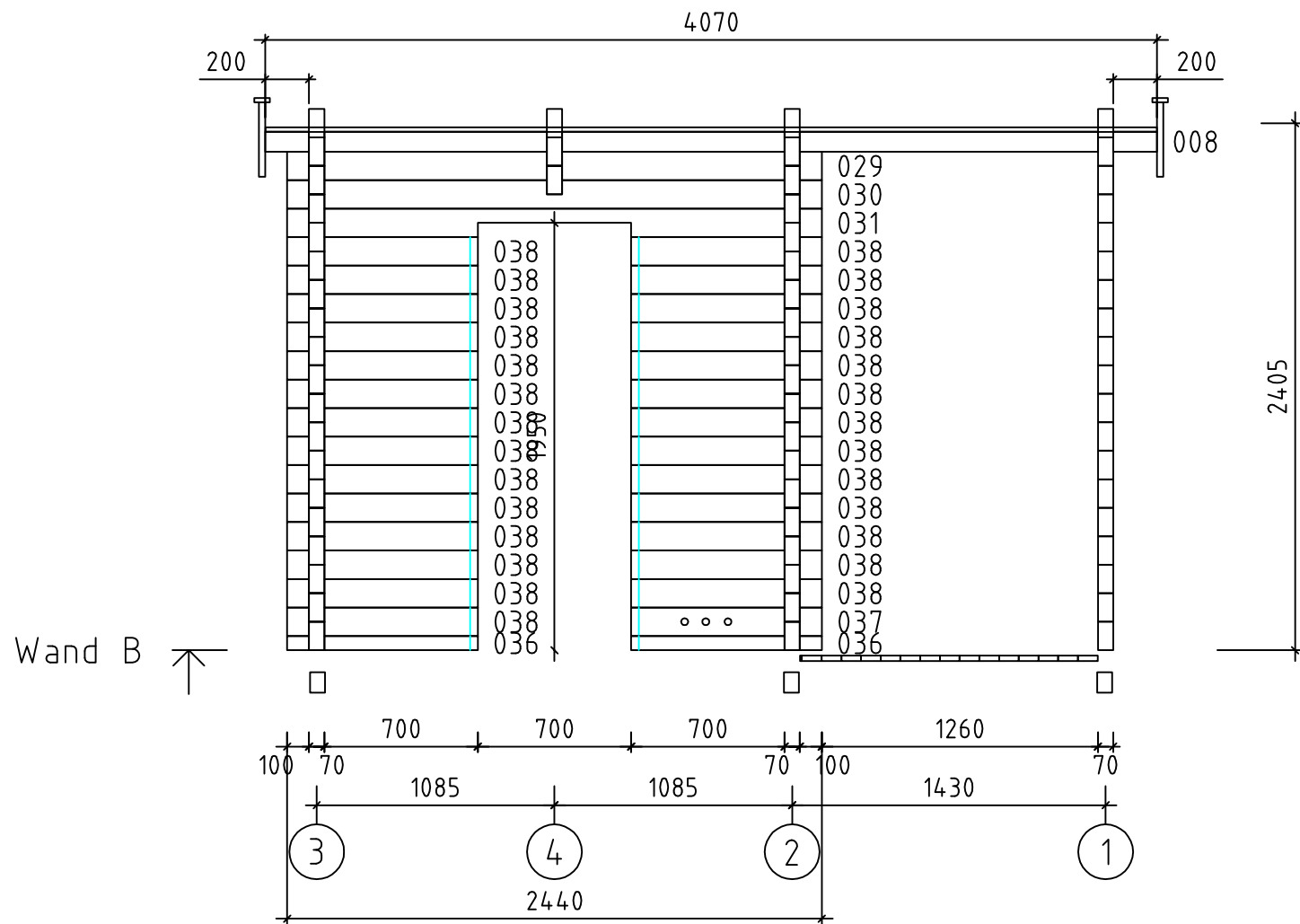



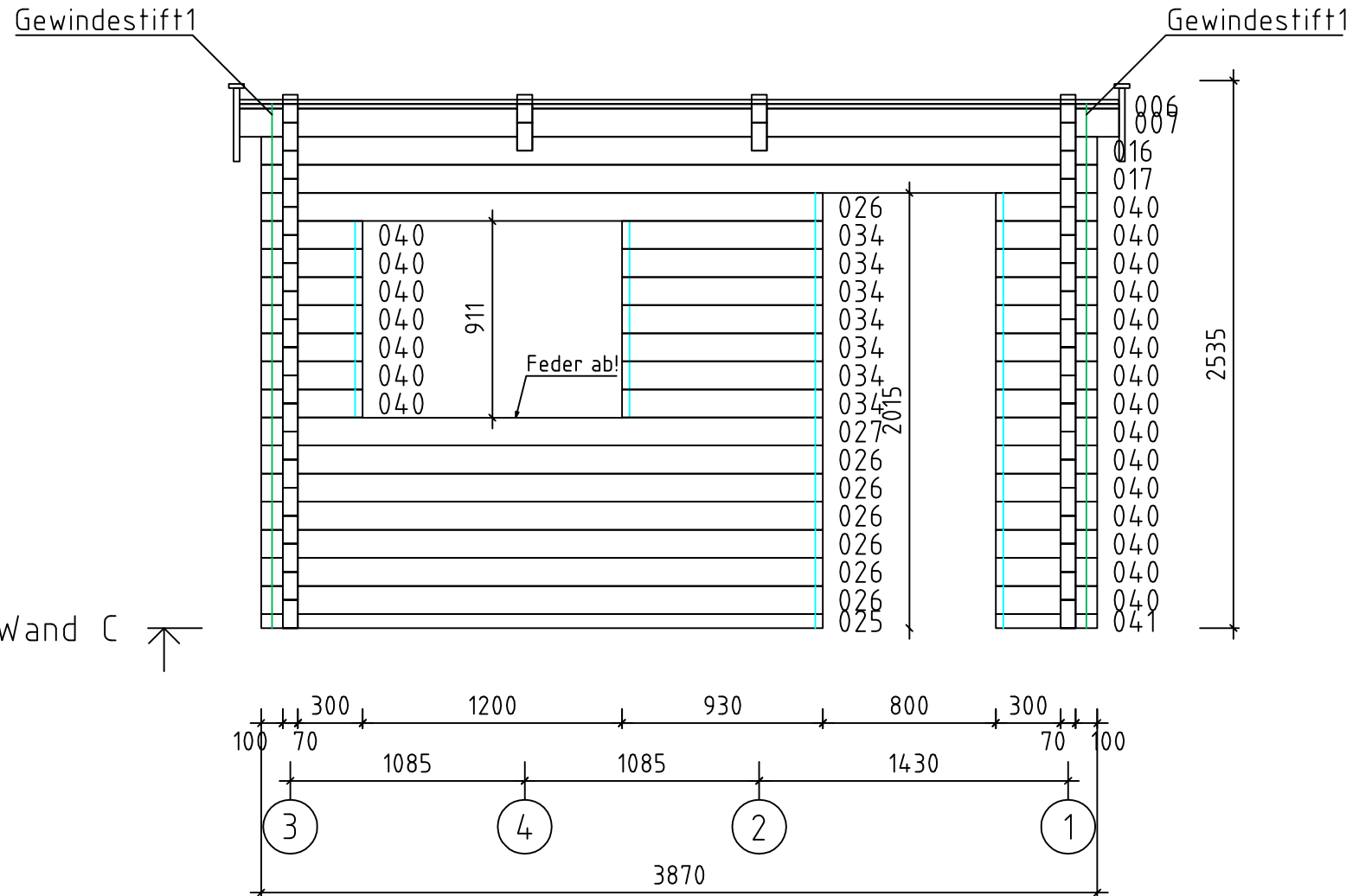



Aussensauna 3940m/70

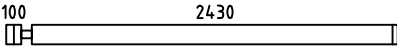
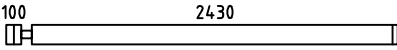
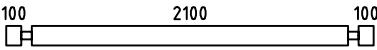
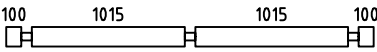
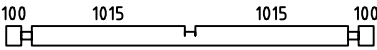
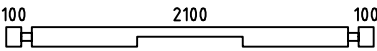
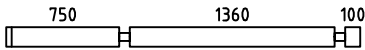
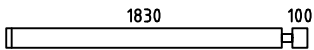
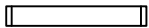
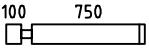
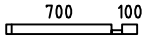
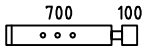
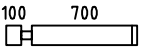
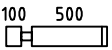

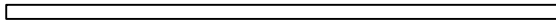
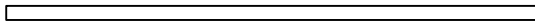
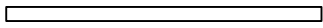
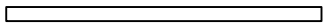
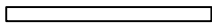

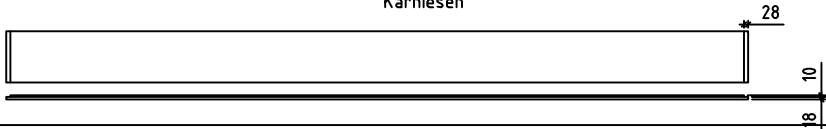



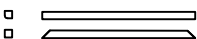

Aussensauna 3940m/70





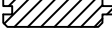

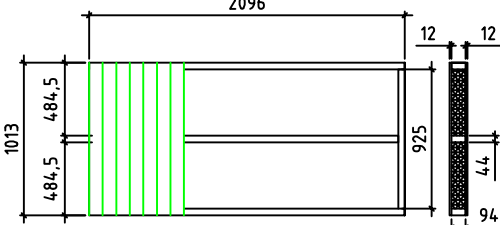
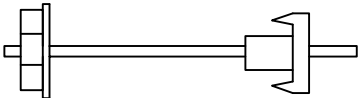
Pos	Aussensauna 3940m/70	ST	F (mm)	L (mm)
001		1	70x130	4870
002		2	70x130	4870
003		1	70x130	4870
004		1	70x130	4070
005		1	70x130	4070
006		1	70x23	4070
007		1	70x130	4070
008		1	70x92	4070
009		1	70x130	4070
010		10	70x130	3870
011		1	70x130	3870
012		1	70x130	3870
013		8	70x130	3870
014		1	70x130	3870
015		1	70x130	3870
016		1	70x130	3870
017		1	70x130	3870
018		1	70x130	3870
019		1	70x130	3870
020		14	70x130	3870
021		1	70x65	3870
022		4	70x130	3067
023		1	70x130	2640
024		1	70x130	2640
025		1	70x65	2600

Pos	Aussensauna 3940m/70	ST	F (mm)	L (mm)
026		7	70x130	2600
027		1	70x130	2600
028		16	70x130	2440
029		1	70x130	2440
030		1	70x130	2440
031		1	70x130	2440
032		4	70x130	2350
033		6	70x130	2000
034		7	70x130	930
035		4	70x130	920
036		2	70x65	870
037		1	70x130	870
038		27	70x130	870
039		6	70x130	670
040		22	70x130	470
041		1	70x65	470
AR1	Fundamentbalken 	2	68x94	3660
AR5	Fundamentbalken 	3	68x94	3524
AR4	Fundamentbalken 	1	68x94	2094
AR2	Fundamentbalken 	10	44x94	2094
AR3	Fundamentbalken 	9	44x94	1362
TR2	Traufenbrett 	2	70x20	4968
TR1	Traufenbrett 	2	70x20	4168
vÖ2	Karniesen 	2	28x340	4926
vÖ1	Karniesen 	2	28x340	4090

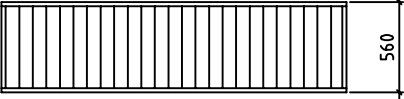

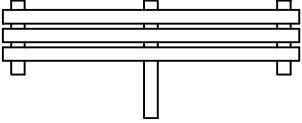
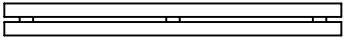
Pos	Aussensauna 3940m/70		ST	F (mm)	L (mm)
DT2	Zwischendecketräger 		4	50x50	2100
DT1	Zwischendecketräger 		4	50x50	1015
0203	Fussbodenbretter 		16	90x26	3528
0203	Fussbodenbretter 		24	90x26	2098
0203	Fussbodenbretter 		25	90x26	1358
	Terrassenbretter 		44	120x28	518
	Dachbretter 		55	90x20	4068
	Deckbretter II Stock 		96	90x20	1013
	Abdeckleiste 			20x40	80m
	 <p>Zwischendecke (Mit ISOVER)</p>		2		
	Gewindestift 1 		2	M12	2500
	Gewindestift 2		2		2300

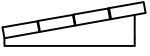
Pos	Aussensauna 3940m/70		ST	F (mm)	L (mm)
A2S91	<div data-bbox="325 165 379 215" data-label="Text">AB</div> <div data-bbox="655 174 863 206" data-label="Text">Fenster 1200x910</div> <div data-bbox="284 246 711 528" data-label="Image"> </div> <div data-bbox="738 250 1046 356" data-label="Text"> <div style="border: 1px solid black; padding: 2px;">           Iso=495x672            Plekk 45x495         </div> </div> <div data-bbox="836 356 1182 421" data-label="Text">           Tenderleiste 23x23x750=2st.            Tenderleiste 23x23x880=2st.         </div>	2			
A60	<div data-bbox="304 568 663 600" data-label="Text">Välja poole avanev (tihendiga)</div> <div data-bbox="756 568 957 600" data-label="Text">Fenster 600x600</div> <div data-bbox="424 640 608 801" data-label="Image"> </div> <div data-bbox="707 663 1015 719" data-label="Text"> <div style="border: 1px solid black; padding: 2px;">           Iso=437x427         </div> </div> <div data-bbox="815 768 1161 799" data-label="Text">           Tenderleiste 23x23x490=2st.         </div>	1R			
T1	<div data-bbox="587 889 745 949" data-label="Text">           Tür 700x1950            Kotike         </div> <div data-bbox="863 904 1219 936" data-label="Text">           Tenderleiste 23x23x1855=2st.         </div> <div data-bbox="572 987 748 1314" data-label="Image"> </div>	1L			
T2	<div data-bbox="703 1435 861 1467" data-label="Text">Tür 800x2015</div> <div data-bbox="884 1482 1238 1514" data-label="Text">           Tenderleiste 23x23x1985=2st.         </div> <div data-bbox="416 1476 663 1942" data-label="Image"> </div> <div data-bbox="707 1556 1015 1612" data-label="Text"> <div style="border: 1px solid black; padding: 2px;">           Iso=477x1541         </div> </div> <div data-bbox="715 1639 791 1671" data-label="Text">           Kotike         </div>	1R			
Kood	Materjal	File	peep.dwg	Leht	3/3

Pos	Aussensauna 3940m/70		ST	F (mm)	L (mm)
054	Liegen		2		2098
055	Aspen		1		1538
056	Träger für Liegen		2	44x68	1100
057			1	44x68	700
058			2	44x68	550
059	Liegenstütze		1	44x68	841
060			1	44x68	391
061	Zwischenbankverkleidung Aspen		1		
062	Rücklehnen Aspen		1R+1L		
063	Ofenschutzgitter		1		
064	Kopfstütze Aspen		2		
065	Schrauben für Liegenträger		50	4x80	
066	Schrauben für Liegen		50	3,5x50	
067	Schrauben für Ofenschutzgitters		20	4x80	
	Lüftungsklapp		1		

