

Aussensauna 3940 / 70 / 13

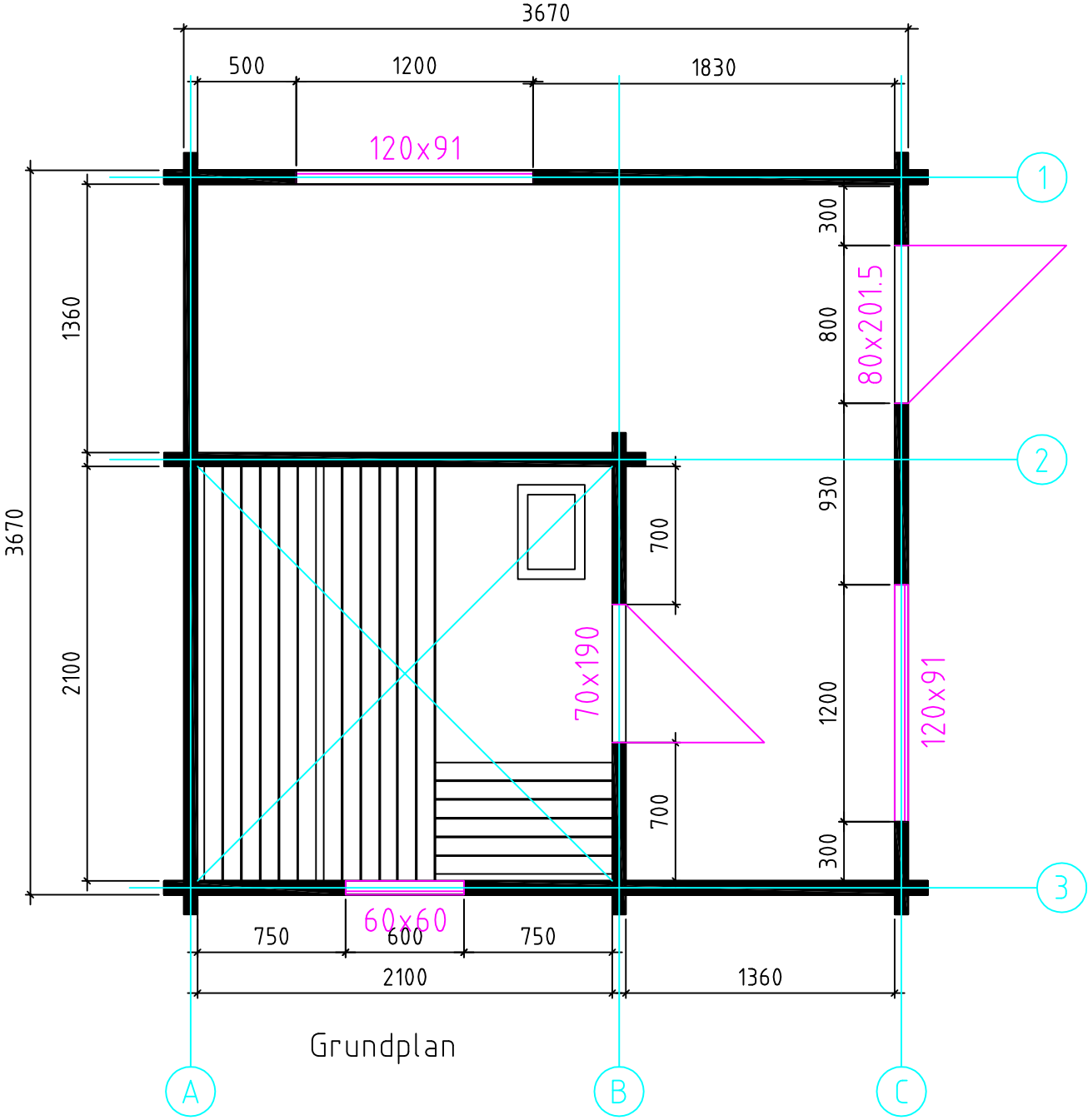

Aussensauna 3940 / 70 / 13



Aussensauna 3940 / 70 / 13

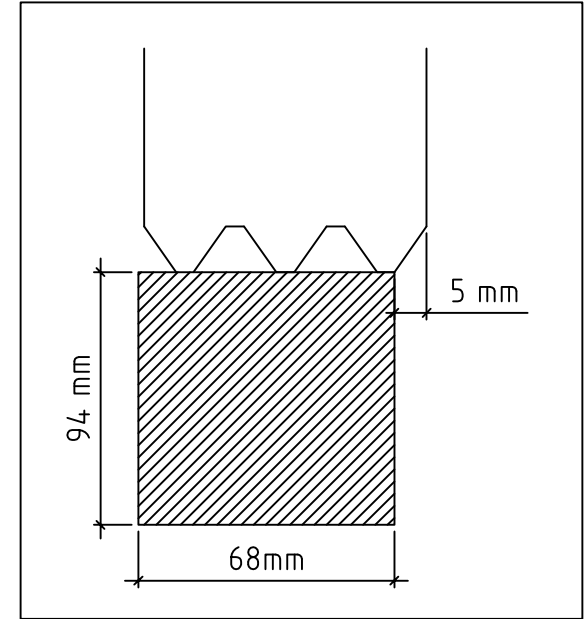
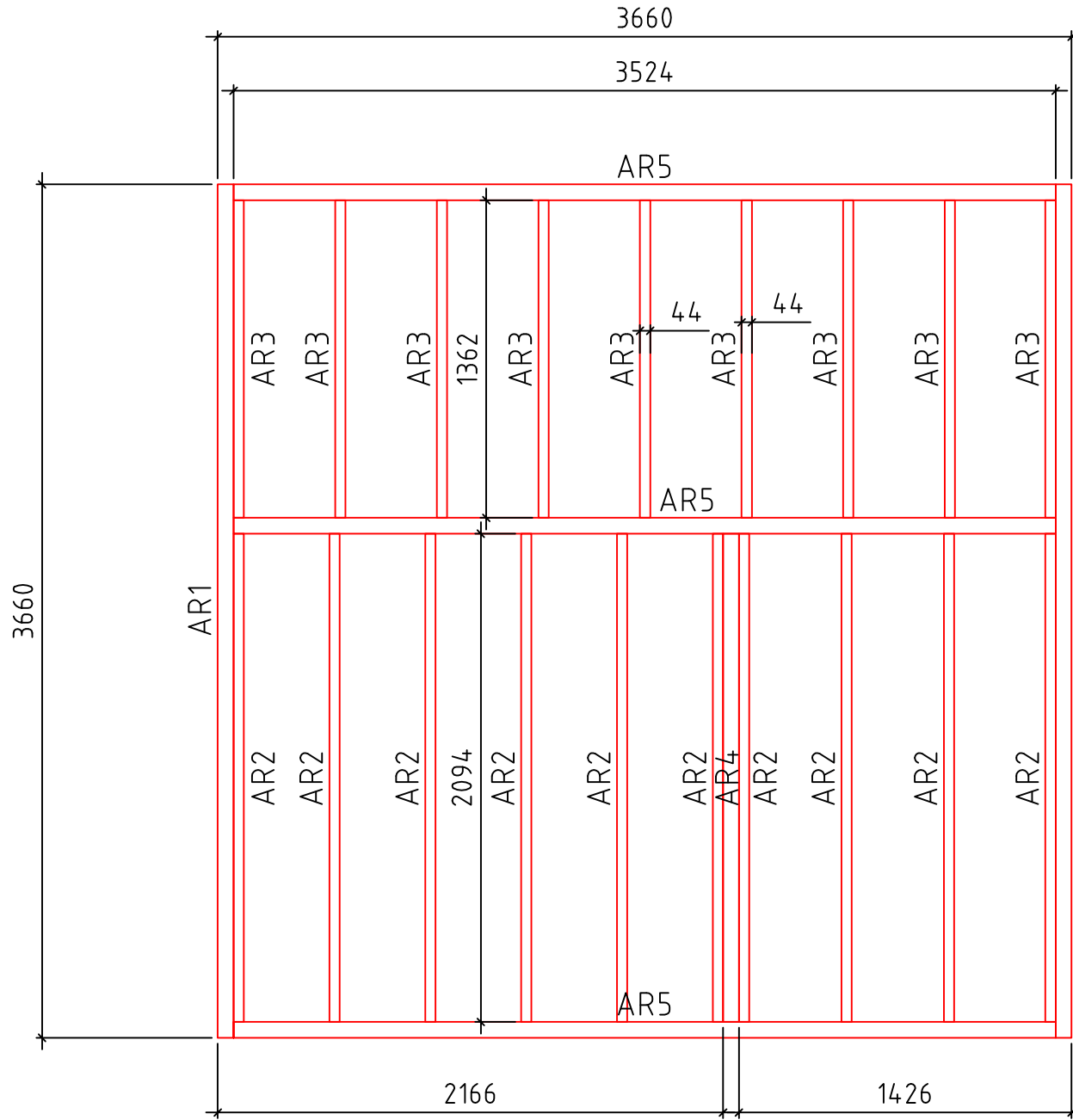

Fundament

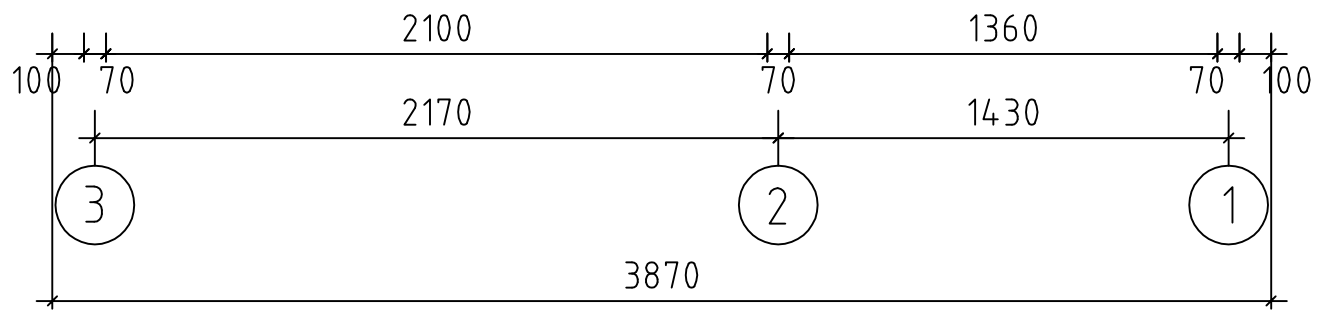
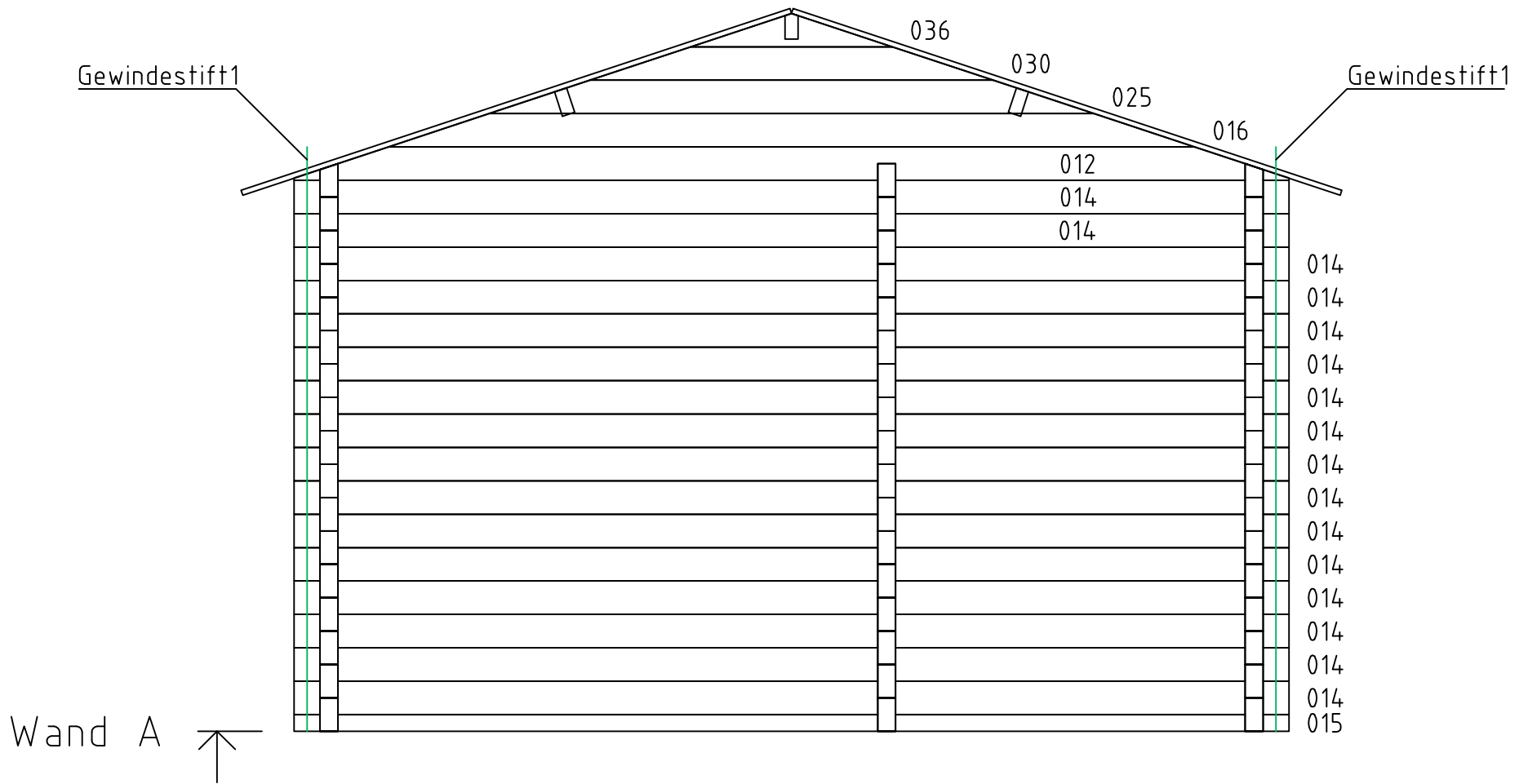

Aussensauna 3940 / 70 / 13

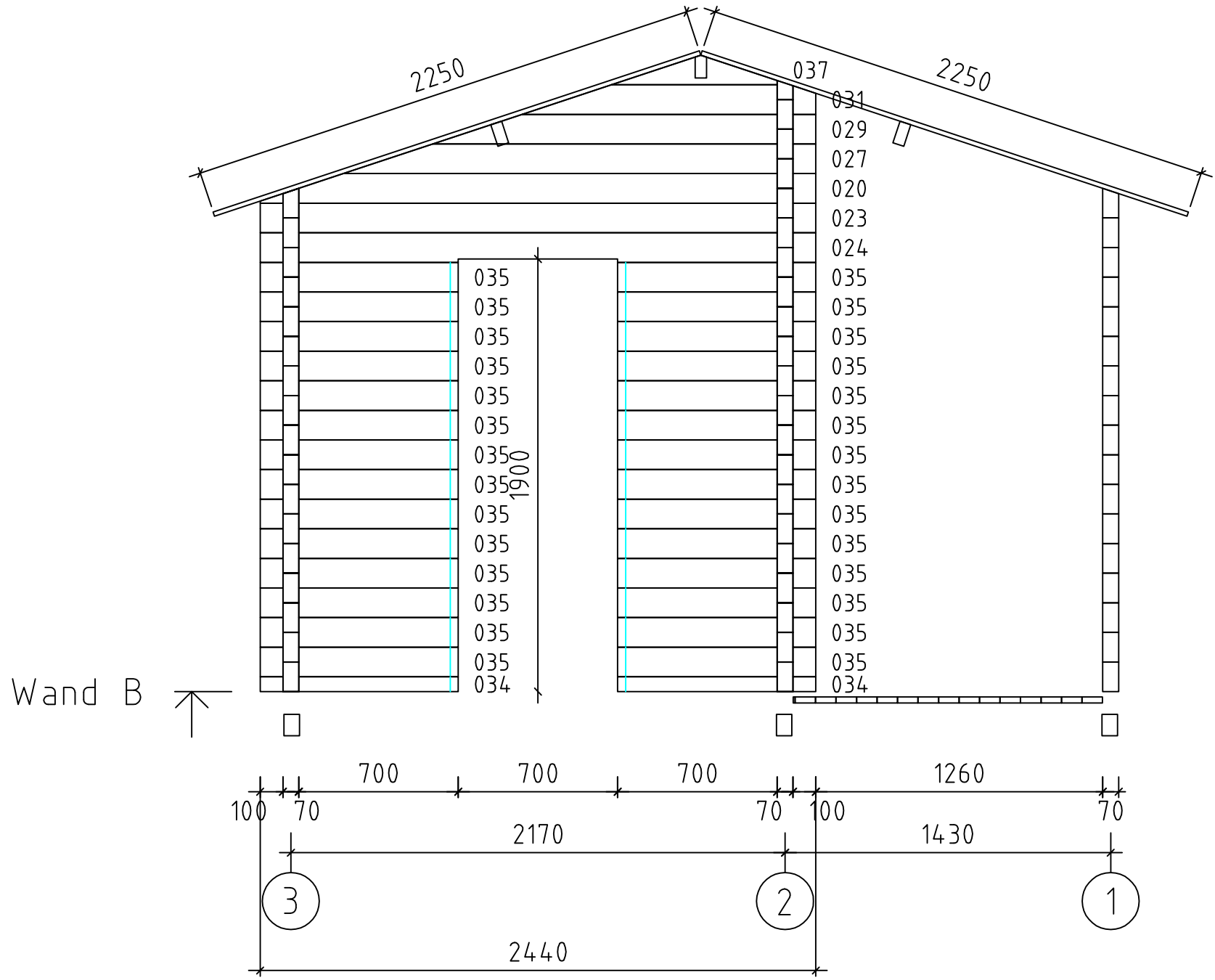

Wand B ↑

Aussensauna 3940 / 70 / 13

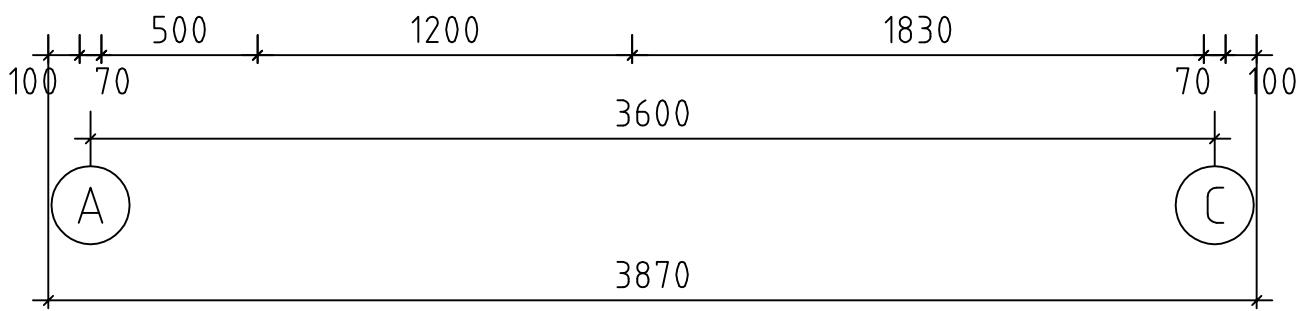
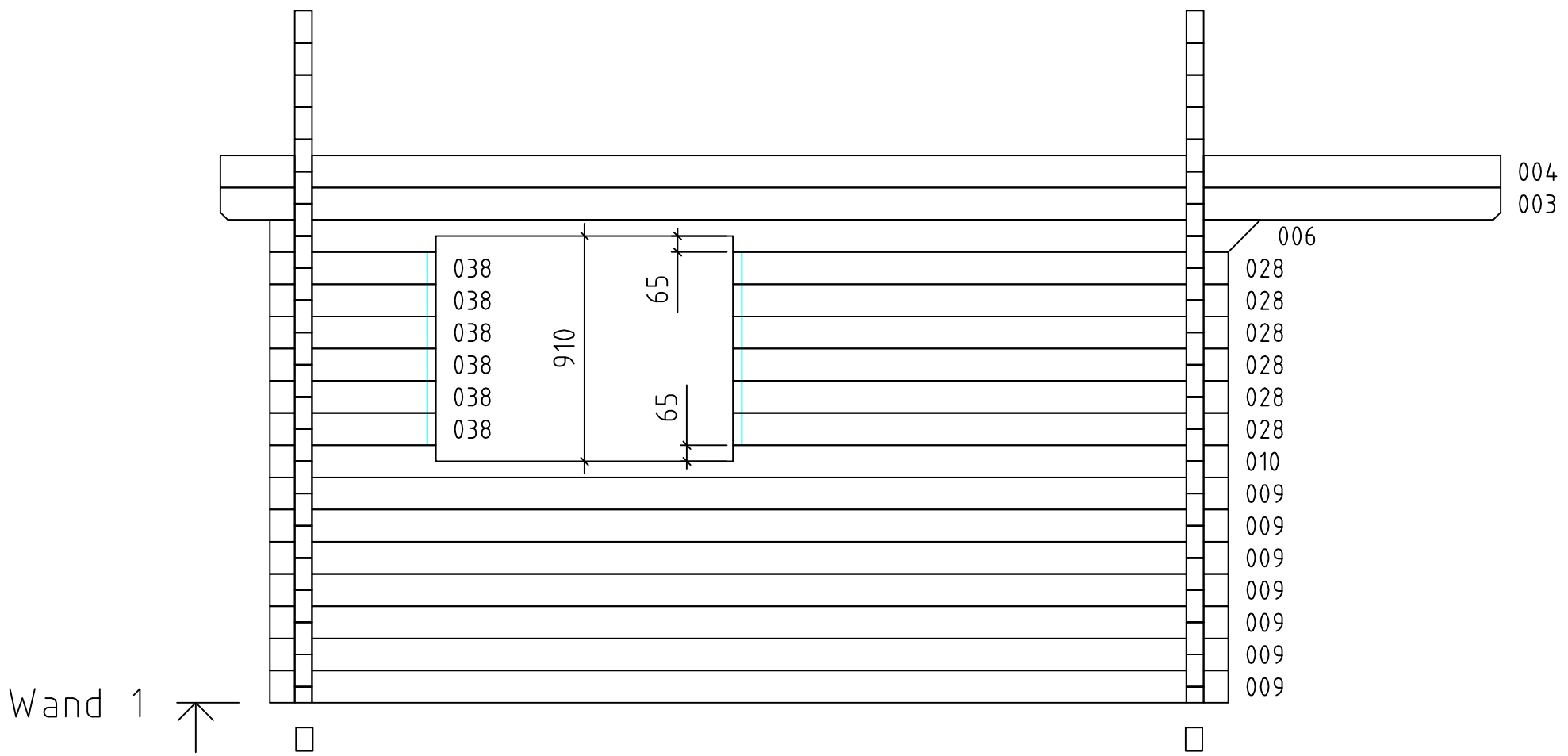

Aussensauna 3940 / 70 / 13

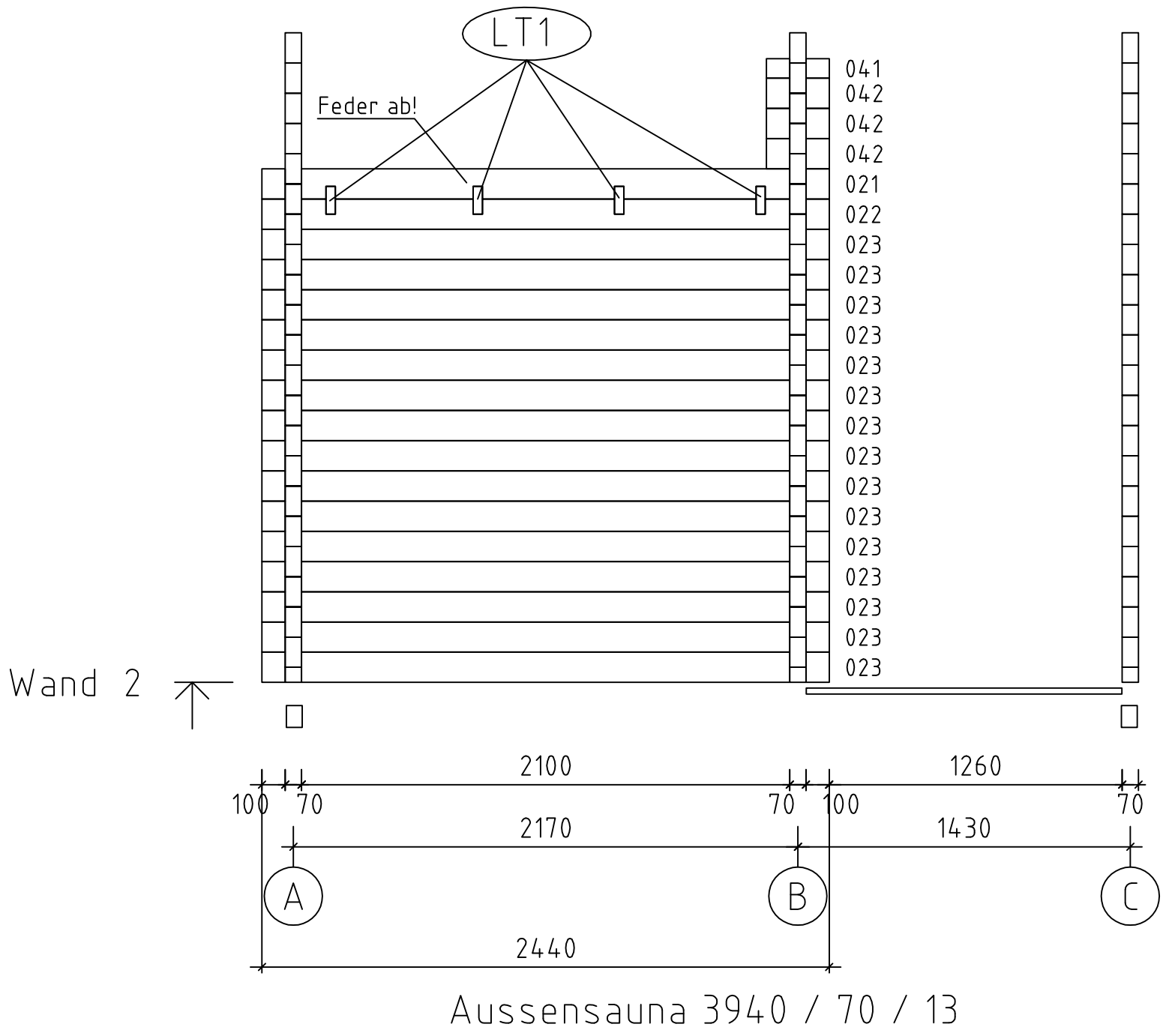

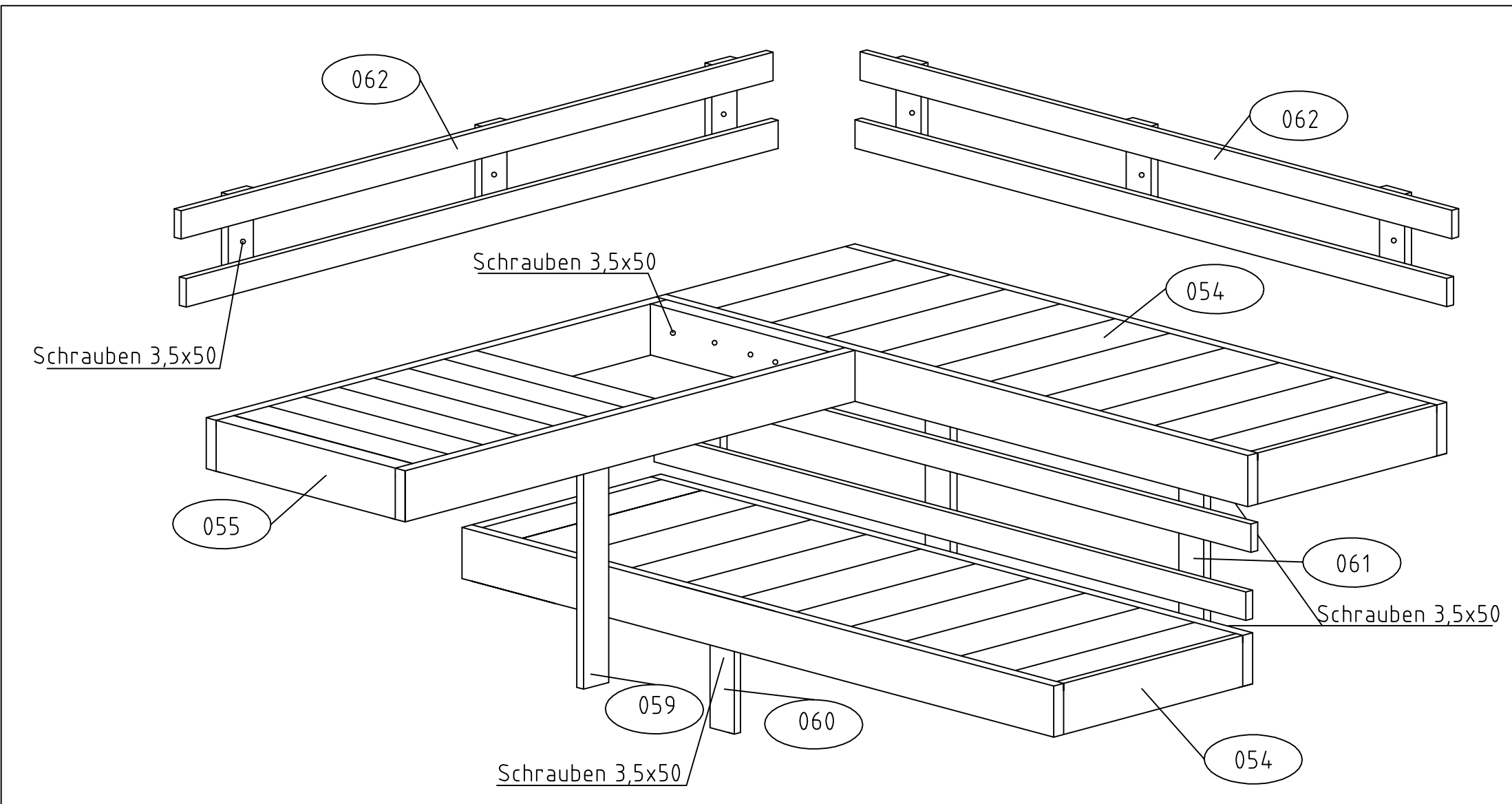

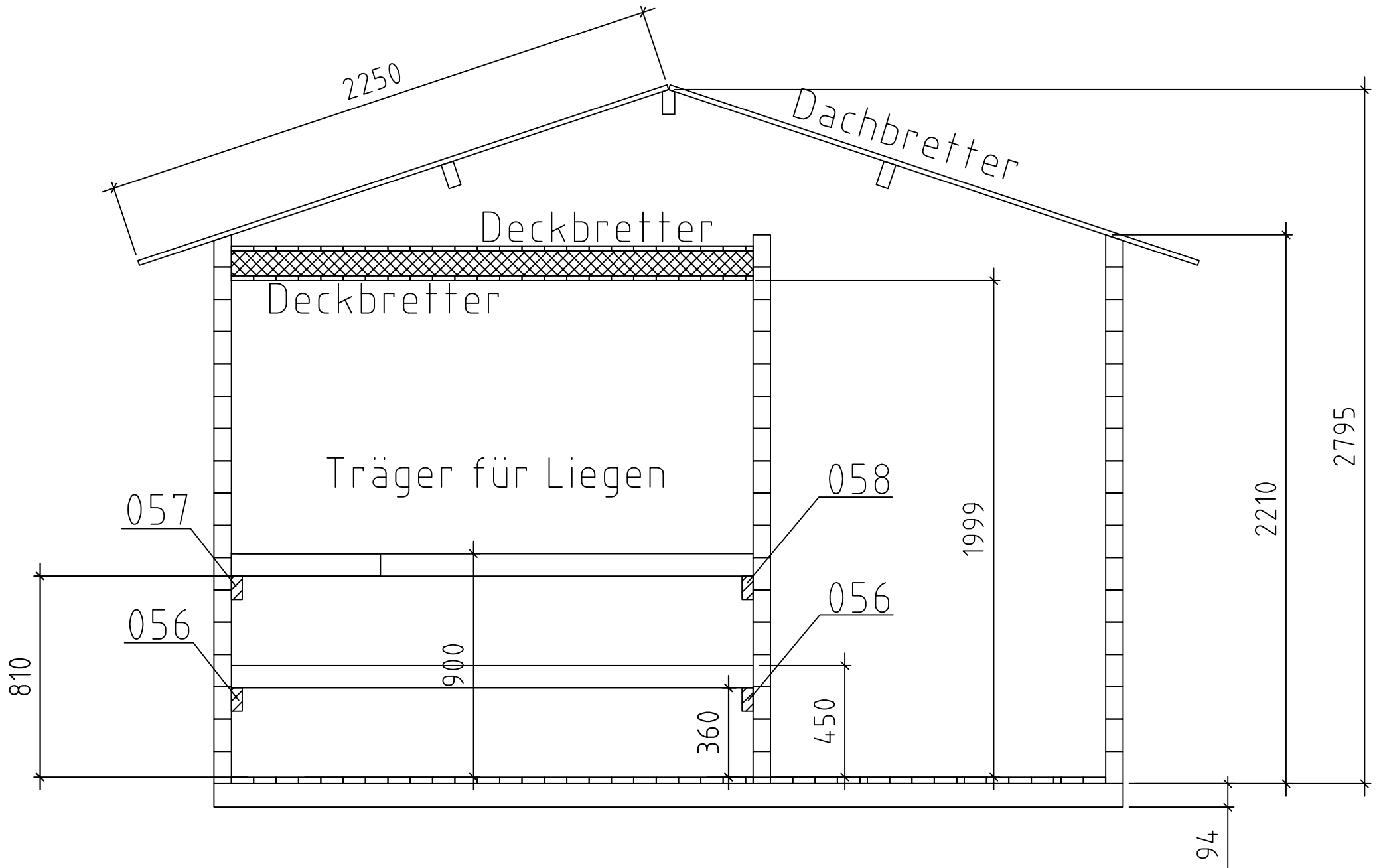



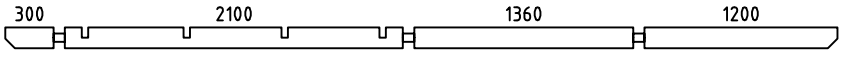
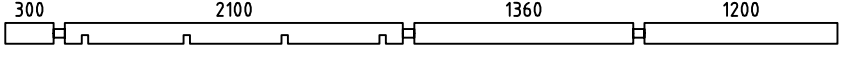
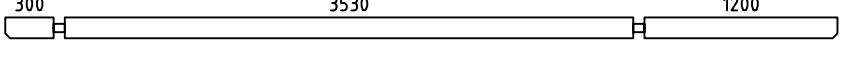
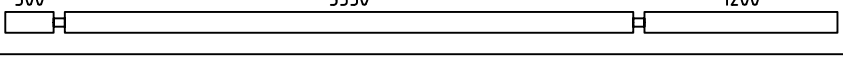
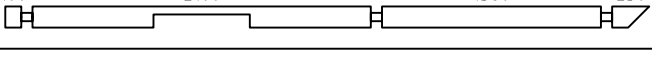
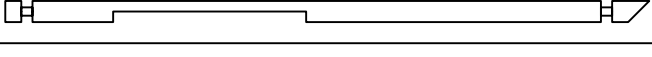
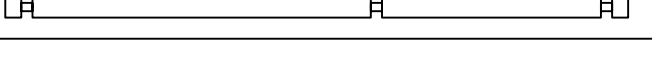
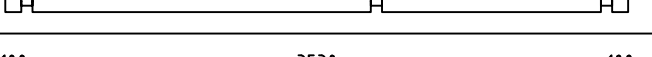
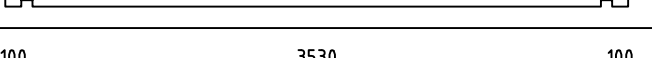
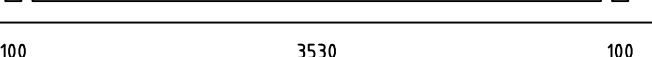
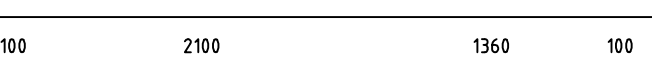
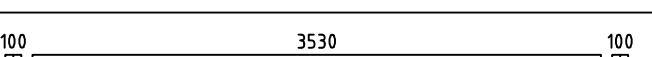
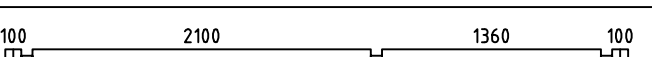
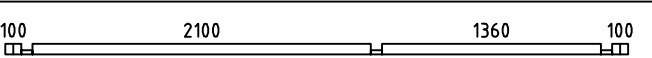
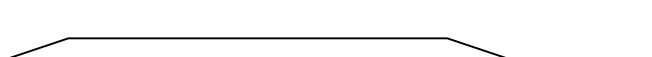
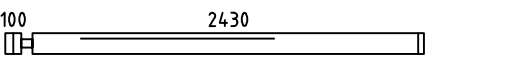
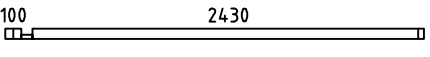
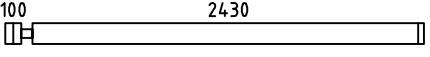
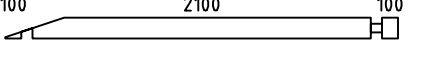
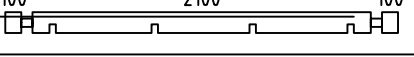
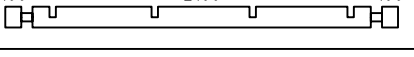
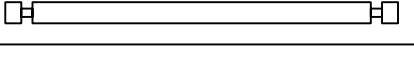
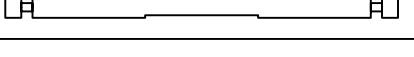
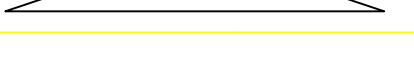

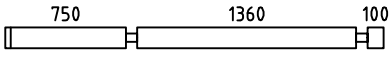
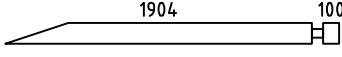
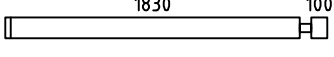
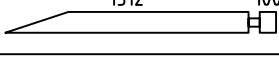
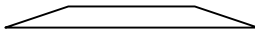
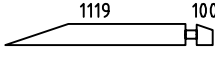
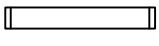
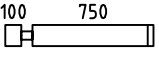
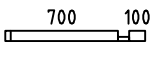
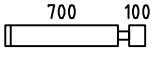
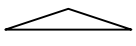
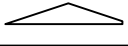
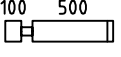
Aussensauna 3940 / 70 / 13

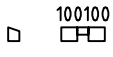
Pos	Aussensauna 3940 / 70 / 13	ST	F (mm)	L (mm)
001		1	70x130	5170
002		1	70x130	5170
003		1	70x130	5170
004		1	70x130	5170
005		1	70x130	4000
006		1	70x130	4000
007		9	70x130	3870
008		1	70x130	3870
009		7	70x130	3870
010		1	70x130	3870
011		1	70x130	3870
012		1	70x130	3870
013		1	70x130	3870
014		16	70x130	3870
015		1	70x65	3870
016		2	70x130	3138
017		1	70x130	2600
018		1	70x65	2600
019		7	70x130	2600
020		1	70x130	2440
021		1	70x130	2440
022		1	70x130	2440
023		16	70x130	2440
024		1	70x130	2440
025		2	70x130	2353

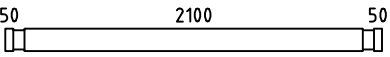
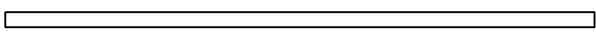
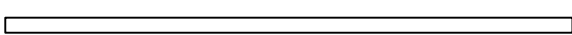
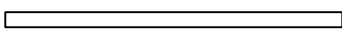
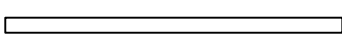
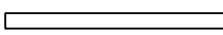
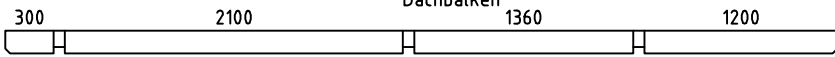
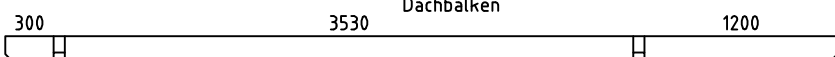
Pos	Aussensauna 3940 / 70 / 13	ST	F (mm)	L (mm)
026		4	70x130	2350
027		1	70x130	2074
028		6	70x130	2000
029		1	70x130	1682
030		2	70x130	1569
031		1	70x130	1289
032		7	70x130	930
033		4	70x130	920
034		2	70x65	870
035		28	70x130	870
036		2	70x130	784
037		1	70x130	727
038		6	70x130	670
039		1	70x65	470
040		22	70x130	470
041		1	70x84	270
042		3	70x130	270
LT1	Deckenbalken 	4	50x140	2340
AR1	Fundamentbalken 	2	68x94	3660
AR5	Fundamentbalken 	3	68x94	3524
AR4	Fundamentbalken 	1	68x94	2094
AR2	Fundamentbalken 	10	44x94	2094
AR3	Fundamentbalken 	9	44x94	1362
PR3	Dachbalken 	1	70x140	5170
PR1	Dachbalken 	1	70x140	5170

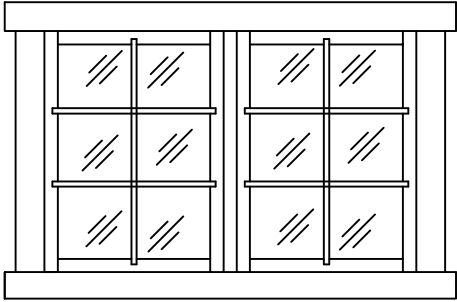
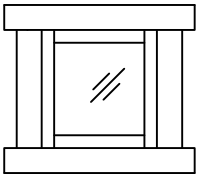
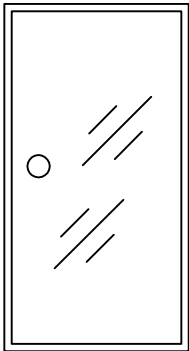
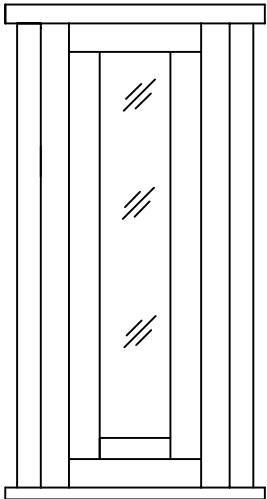
Pos	Aussensauna 3940 / 70 / 13		ST	F (mm)	L (mm)
A2S91	<div data-bbox="231 123 292 174" style="border: 1px solid black; padding: 2px;">BC</div>	<p data-bbox="587 136 810 165">Fenster 1200x910</p> <div data-bbox="189 210 647 510">  </div> <div data-bbox="675 215 837 275" style="border: 1px solid black; padding: 2px;">ISO</div> <p data-bbox="778 331 1150 394">Tenderleiste 23x23x740=2st. Tenderleiste 23x23x870=2st.</p>	2		
A60	<p data-bbox="210 557 596 586">Välja poole avanev (tihendiga)</p> <div data-bbox="338 631 536 804">  </div>	<p data-bbox="694 557 911 586">Fenster 600x600</p> <div data-bbox="643 656 805 716" style="border: 1px solid black; padding: 2px;">ISO</div> <p data-bbox="756 770 1128 799">Tenderleiste 23x23x480=2st.</p>	1R		
T1	<p data-bbox="233 896 438 925">Alumise pakuga!</p>	<p data-bbox="512 896 683 925">Tür 700x1900</p> <div data-bbox="497 1003 686 1352">  </div> <p data-bbox="809 913 1187 943">Tenderleiste 23x23x1855=2st.</p>	1L		
T2	<div data-bbox="328 1527 596 2024">  </div>	<p data-bbox="639 1482 810 1512">Tür 800x2015</p> <div data-bbox="632 1612 761 1673" style="border: 1px solid black; padding: 2px;">ISO</div> <p data-bbox="829 1534 1208 1563">Tenderleiste 23x23x1985=2st.</p>	1R		

