

WOODEN POOLS

Octagonal

DOUBLE WIDTH PINE COPING



INSTALLATION AND OPERATING INSTRUCTIONS

to be read carefully and kept for future reference

1. WOOD, A NATURAL MATERIAL	4
1.1 Colour variations	4
1.2 Resin beads.....	4
1.3 Salt stains	4
1.4 Greying	4
1.5 Splitting and cracking	5
1.6 Knots.....	5
1.7 Surface mould	5
1.8 Joined wood.....	5
1.9 Curved wood	5
2. FOREWORD	6
3. STORAGE & TIME REQUIRED FOR ASSEMBLY	6
3.1 Storage.....	6
3.2 Safety	7
4. OVERVIEW OF THE ASSEMBLY STEPS	7
4.1 Tools.....	7
4.2 Time for assembly	7
5. SITING AND PREPARATION OF THE GROUND FOR OCTO & OCTO+ POOLS	8
5.1 Octo pools	8
5.2 Octo+ Pools.....	8
6. IN-GROUND AND PARTIALLY IN-GROUND CONFIGURATIONS.....	9
6.1 Octo pools	10
6.2 Octo + pools	11
7. ASSEMBLY OF THE OCTO POOL STRUCTURE	13
7.1 Laying the underlay	16
8. ASSEMBLY OF THE OCTO+ POOL STRUCTURE	17
9. APPLYING THE GASKETS	22
10. LAYING THE LINER.....	23
11. INSTALLATION AND COMMISSIONING OF THE FILTRATION GROUP .	26
11.1 Installation of the filter	26
11.2 Mounting the rigid descending pipes	28
11.3 Assembly of the filter	30
11.4 Collector and pump/filter module.....	32
11.4.1 Odyssea models	32
11.5 Connecting the pipes	33
11.6 Filling the pool	34
11.7 Filling the hydraulic circuit with water.....	34

12. COPING	34
12.1 Installation of the coping - Weva.....	34
12.1.1 Octo and Octo + pools	34
12.2 Installation of the coping - Odyssea	36
12.2.1 Octo pools.....	36
12.2.2 Octo+ pools.....	36
13. INSTALLATION OF THE LADDERS.....	37
13.1 Stainless steel ladder	37
13.2 Wooden access ladder	37
14. COMMISSIONING AND OPERATING RECOMMENDATIONS	39
14.1 Recommendations and advice	39
14.2 Filter and valve operation	39
14.3 Length of the filtration cycle.....	39
14.4 Cleaning the pre-filter and filter back wash	40
14.4.1 Pre-filter	40
14.4.2 Filter.....	40
15. POOL OPERATION AND MAINTENANCE	41
15.1 Water treatment.....	42
15.2 Accessories.....	42
15.3 Winterizing the pool.....	42
15.3.1 Winterizing the hydraulic installation.....	43
15.4 Hygiene.....	43
16. DO NOT PLAY WITH SAFETY !!!	44
17. GUARANTEES.....	45
17.1 Wooden elements	45
17.2 Accessories.....	45
18. APPENDICES - POOL EXPLODED VIEWS.....	48
18.1 Exploded view - OCTO pool.....	48
18.2 Exploded view - OCTO+ pools.....	49

1. WOOD, A NATURAL MATERIAL

Being a natural material, wood will have some imperfections. These are normal and have no impact on the service life of the product.

A certain number are superficial and are not covered within the scope of the guarantee.

1.1 Colour variations

Colour variations are common to every species of wood. Treatment brings them out because the depth of penetration of the product will depend on the wood density and grain. Weathering of wood outdoors will significantly attenuate these colour variations.



1.2 Resin beads

When resinous wood species are autoclaved, the alternating pressure and vacuum can cause sticky residue to rise to the surface. To remove it, scrape it carefully with an appropriate tool, being careful not to touch the wood. Turpentine spirits could also be effective, but could stain the wood if too much is applied.



1.3 Salt stains

Small green stains are frequently found on the surface of autoclaved wood. These can be removed with light sanding. If left untreated, this colour will disappear over time.

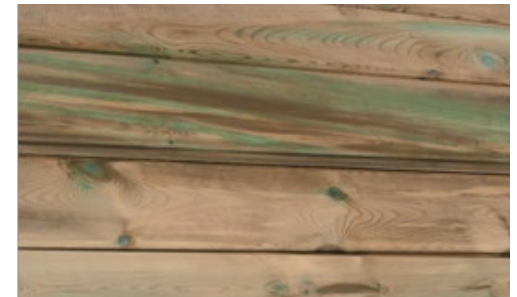

1.4 Greying

Wood exposed to the sun and the moon is susceptible to greying. Some of the wood could already be greyed due to the storage conditions of the various elements of the structure. This is a natural phenomenon that has no impact on the structural integrity of the product. The colour of the whole structure will even out after a few months of exposure.



1.5 Splitting and cracking

Wood expands and contracts when exposed to variations in humidity and temperature. As it dries, wood contracts unevenly resulting in the appearance of cracks. While these can seem to be cause for concern, they have no impact on the mechanical properties of the product and therefore do not fall within the scope of the guarantee.

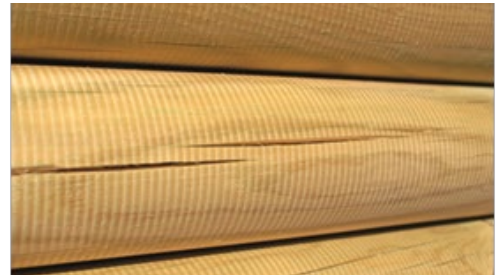

1.6 Knots

Knots mark the places where branches were attached. The quantity and size depends on the species of wood and the sorting process. For outdoor installations, small adherent knots are acceptable.



1.7 Surface mould

Mould, caused by microscopic fungi, can grow on wood, particularly on resinous species, on which the growth can appear as "blueing". It is a surface phenomenon, exacerbated by heat, humidity and inadequate aeration and is characterised by stains ranging from light to dark blue. They can be removed by wiping the surface.

Remember that class IV treated wood is protected against attack by fungi that could destroy the physical and mechanical properties of the wood.



1.8 Joined wood

To ensure the highest quality in the selection of our wood, it is sorted meticulously before planing. Sections that features defects on both sides are removed and the wood is then joined together (see image).

This in no way penalises the mechanical properties of the wood.

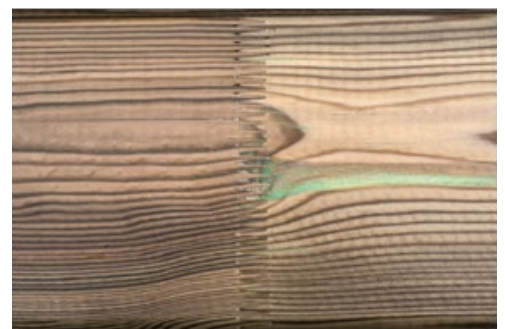

1.9 Curved wood

Due to the constant pressure exerted by the water, the walls of the pool may curve slightly over time.

This phenomenon, attributable to the natural elasticity of wood, will stabilise of its own accord and in no way would lead to failure of the wooden slats. It is not a defect, and would not constitute grounds for a guarantee claim.

2. FOREWORD

Congratulations on acquiring your pool. We have taken great care with the design and manufacture of your pool to provide you with a top quality product.

The wood used to make the various elements (interlocking walls, coping, ladder, etc.) was carefully selected. Outdoors, these wooden elements are subject to constant weathering: contact with the ground, temperature variations, exposure to sunlight, rain and frost, insect attack, etc. The wood's ability to withstand this aggression depends on the origin of the wood and the method used to treat it.

For this reason, we choose pine from extensive, sustainably managed forests in northern Europe. Why do we insist on this? Because the more rigorous climates above the 57th parallel favour very slow tree growth, making the wood stronger and more resilient.

The wood is autoclaved, this involves subjecting the wood alternately to pressure and vacuum in order to drive the treatment chemicals into the heart of the wood as opposed to other more superficial treatment techniques such as soaking.

Class IV treated wood in contact with the ground is immune to insect attack and rotting caused by humidity. Autoclave treatment is guaranteed 10 years, in accordance with standards currently in effect.

Depending on the model, your pool is equipped with either grooved pine coping or grooved composite coping.

Wood is a living material, variations in temperature and humidity can cause it to expand or contract so take care to follow the storage and assembly instructions concerning the wooden structure. Similarly, prolonged exposure to UV light can cause wood to grey. These are natural phenomena that in no way effect the service life of the products.

Do not apply any product to the wood (for example: wood stain, micro-porous products, etc.).

3. STORAGE & TIME REQUIRED FOR ASSEMBLY

We shall now explain how to assemble your pool, but first some instructions before you begin.

Please read these instructions carefully, this will allow you to prepare each stage to achieve optimum efficiency. Please keep these instructions for future reference.

You should take the time to go through the components using the nomenclature page enclosed with the accessories kit and make sure that no items are missing.

Keep the following documents;:

- the productions sheets for the various kits
- proofs of purchase

3.1 Storage

If you do not intend to assemble your pool immediately, you should store it without opening it, in a well ventilated room, or failing this, in an area protected from humidity and sunlight. Once the pallets are undone, the kit must be assembled within 24 hours. Once work has begun, try to avoid leaving the structure exposed to significant climatic variations (sun, rain) that could cause the wood to “work” too quickly. This could lead to deformations that could render the item unusable. By preference, the wooden structure should be assembled in one go on a day that is not too hot. The liner or PVC waterproofing membrane should be stored at a minimum of 20°C for at least 24 hours before it is fitted. This is to render the liner more supple and thus facilitate fitting. The liner should only be fitted if the ambient temperature is higher than 20 °C.

3.2 Safety

- Your installation must comply with the electrical standards in effect in the country where the pool is to be installed. In France this is the C15-100 standard which notably requires that the pump power supply be protected by a 30 mA residual current device. (Do not hesitate to call in a professional to ensure the compliance of your installation).
- The kit provided allows the filtration group to be installed 3.5 m from the pool, as required by the French standard concerning above-ground pools.

We recommend that you secure access to your pool using one of the protective measures set out in the standards NF P 90-306, 307, 308 & 309: protective barrier - alarm - safety cover - shelter.

- Children using the pool should be supervised by a responsible adult.
- Remember to remove the wooden access ladder when you are finished using the pool to prevent unsupervised use of the pool.
- This pool is designed for family use only.
- Do not install your pool underneath electrical wires.

4. OVERVIEW OF THE ASSEMBLY STEPS

- earthworks
- assembly of the metallic structure
- pouring the concrete slab
- the wooden structure
- the filtration group

4.1 Tools

- a measuring tape
- cord
- a mallet
- a metal saw
- a socket spanner or wrench (13 and 17)
- a screw driver (with torx bit)
- a flat head and cross head screw driver
- a fine grained file & excavation equipment
- a large bubble level
- a bolt cutters
- sand paper
- a Stanley knife

4.2 Time for assembly

Excavation: **1 TO 2 DAYS (DEPENDING ON THE EQUIPMENT USED)**

Metallic structure: **1 DAY (WITH 2 PEOPLE)**

Pouring the concrete slab: **1 TO 2 DAYS (WITH 2 PEOPLE, DEPENDING ON THE EQUIPMENT USED)**

Wooden structure and filtration group: **2 TO 3 DAYS (WITH 2 PEOPLE - THE TIME INDICATED DOES NOT INCLUDE THE CONCRETE CURING TIME)**

Curing of the concrete slab: **2 TO 3 WEEKS**

CAUTION

Once the structure has been assembled, the liner must be fitted and the pool must be filled with water within at most 5 days. Past this time limit, the structure will need to be carefully inspected to ensure the absence of any deformation (movement of the slats, shrinkage, etc.) that could impact the structural integrity of the work. In the event that gaps appear between the slats, reengage the slats properly before fitting the liner.

5. SITING AND PREPARATION OF THE GROUND FOR OCTO & OCTO+ POOLS

This is the most important step in the procedure as the pool site will determine the service life of your pool. There are some rules that must be respected.

Given the vast number of possible variations (slope, type and homogeneity of the ground, possible issues with drainage, etc) we cannot provide recommendations for every possible permutation here. Some optional steps, such as pouring a concrete slab, laying foundations, footing, laying drains, etc will require assistance from professionals who will be able to advise you on solutions best suited to your configuration.

We will explain how to prepare the ground without any concrete, the objective being to achieve a flat, level bearing surface. In as far as possible, avoid siting your pool under trees (to stop you pool from being filled with leaves) or near rises or dips in the ground that could expose children to danger. Do not assemble your pool under electrical cables. On a slope, never back fill under your pool to bring the bearing surface level, always cut into the upward slope.

Lastly, avoid preparing the ground and assembling the pool while a strong wind is blowing

How should the pool be oriented? Ideally, the pool should be oriented so that the skimmers are facing into the prevailing wind. This will determine the final orientation of your pool and the manner in which it will lie in your garden, notably in the case of elongated pools.

5.1 Octo pools

For above-ground configurations only.

To begin, clear the ground of plants and other miscellaneous objects. Next, level and smooth the surface using a spade, rake and a pickaxe (if necessary). Make sure that you smooth out any bumps or rough areas that could damage the underlay, or more seriously, the liner (waterproofing membrane).

After a rough preparation of the surface, plant a stake in the centre of the circle and mark the point where it comes into contact with the ground.

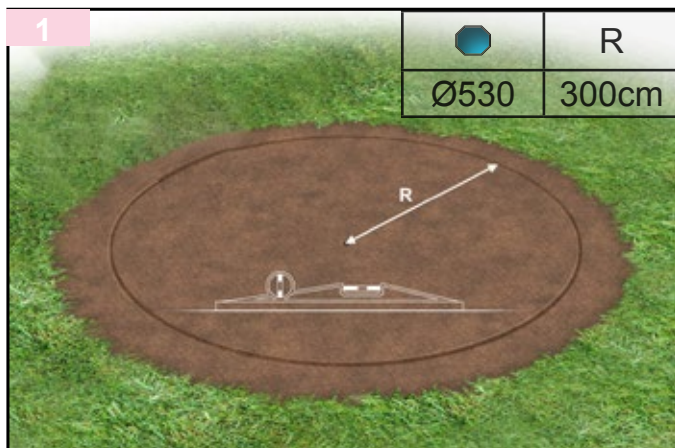

Next, using a flat, straight piece of wood longer than the radius of your pool, go around the circle checking that the ground is level. This operation requires two people (one to make sure that the bottom of the wood corresponds to the mark on the stake, and the other to check the level and move the wood around the entire circumference to ensure that the surface is perfectly level).

5.2 Octo+ Pools

For an above-ground configuration only. The procedure and tips for in-ground and partially in-ground configurations are provided in the following chapter.

Mark out the intended location of the pool and clear the ground of plants, grass and any other miscellaneous objects. Next, level and smooth the surface using a spade, rake and a pickaxe (if necessary). Make sure that you smooth out any bumps or rough areas that could damage the underlay, or more seriously, the liner (waterproofing membrane). Make sure that the bearing surface is completely flat and perfectly level.

Once the ground has been prepared, use string to mark out the longitudinal axis (A1) of your pool and then the transversal axis (A2) perpendicular to the axis A1.

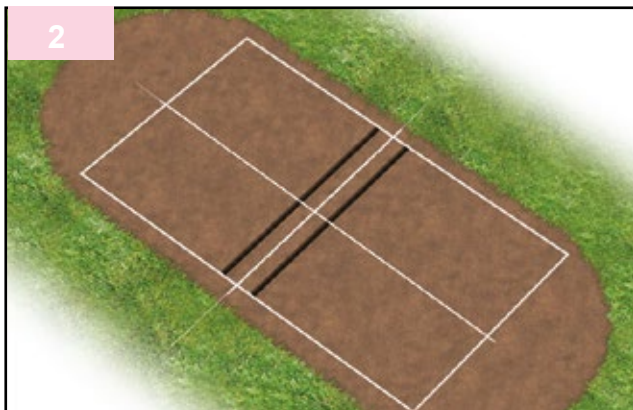

	Length	Width
+640	640	400
+840	840	490

The dimensions shown in this table do not take the footprint of the access steps or plant housing into consideration.

6. IN-GROUND AND PARTIALLY IN-GROUND CONFIGURATIONS

CAUTION:

In France, with this type of configuration, the installation a safety system compliant with French standards governing the safety of in-ground pools is mandatory: a safety barrier, an alarm, a safety cover or a shelter.

The decree no. 2003-1389 dated 31/12/2003 requires the person in charge of the project, installing a pool after the 1st of January 2004, to equip the pool with a means of securing the pool to prevent drowning. Said means must be compliant with either French standards, or with the standards or technical specification or manufacturing processes in effect in the country of installation, guaranteeing an equivalent level of safety.

These provisions apply to outdoor, in-ground or partially in-ground pools.

In the following, we will suggest installation configurations and basic recommendations for ground that is not wet. These will need to be adapted to your particular installation, notably in humid areas (standing water, springs, flood zones, etc.), the drainage system may demand the installation of a condensate pump.

In any case, an in-ground or partially in-ground configuration will require a suitable drainage system to evacuate any standing water that could cause the wood to rot. Furthermore, we recommend that the assembly instructions be followed carefully, failure to respect these instructions will render the usual guarantees nul and void.

The slab under the pool should comply with the rules of the art.

Should you have any doubts, and in order to ensure a quality installation, seek the advice of a specialist.

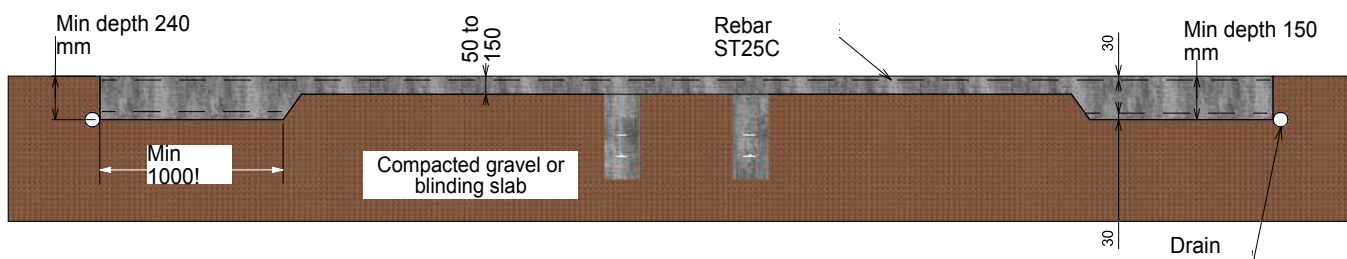

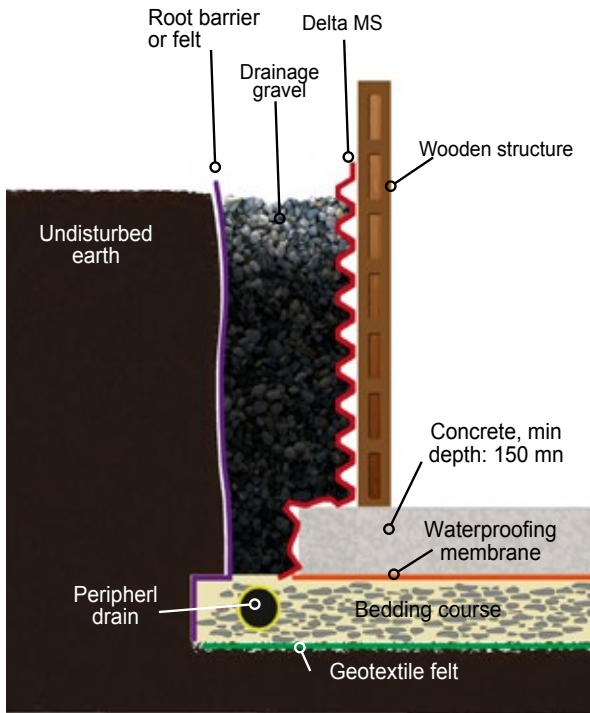

Excavation

The Delta MS membrane allows ventilation of the wooden pool structure. Any crawl spaces should be properly ventilated to prevent rotting of the wood.

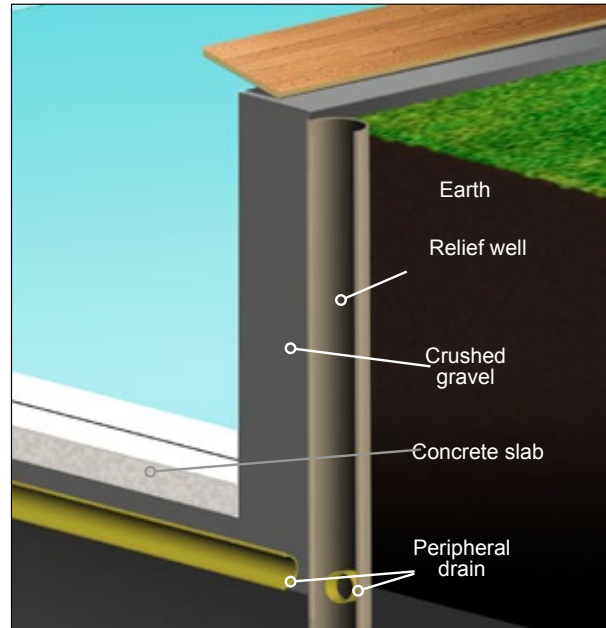

Relief Well

6.1 Octo pools

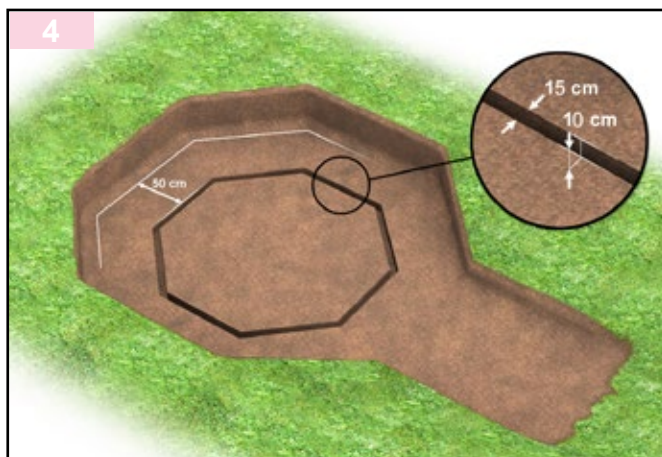

For selection of the site, refer to the instructions at the beginning of this document.

Once the excavation is at the required depth, make sure that the surface is perfectly flat and level. Next, dig a trench to allow drainage under the walls of the pool. Trace the shape of the trench, to assist this process you may temporarily assemble the first row of slats. It should be wide enough to extend beyond each side of the wall once it is built.

If you intend to install the filtration system in a box adjoined to the pool, remember to dig a trench to run the power cable. Similarly, if the filtration system is to be installed at a distance from the pool, dig a trench to accommodate passage of the suction and return lines.

Maximum depth of the excavation:

pool height 133cm = 129cm

pool height 146cm = 142cm

IMPORTANT

The structural dimensions and measurements listed have a tolerance of +/- 3% (European standard EN 16582-1). The AFNOR AC P90-321 agreement allows the following deviation in terms of depth:

- For a depth less than or equal to 25m : +/-3cm
- For a depth greater than 1.25m and less than or equal to 1.65m : +/-5cm
- For a depth greater than 1.65m : +/-8cm

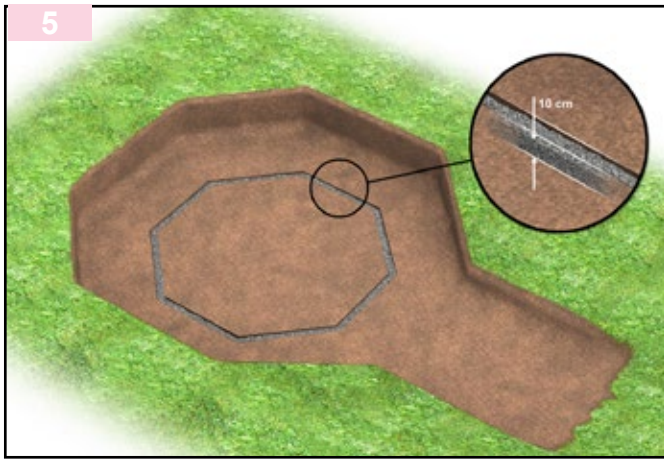

After the trench under the pool wall is dug, fill it to a depth of approximately 10cm using small sized gravel. Make sure that the gravel is well compacted to avoid future subsidence that will impact the pool structure. Finish filling the trench with compacted sand, the filled trench should be level with the ground.

CAUTION!

We strongly recommend that you install the filter below the water line. If the filter is installed above the water line, there is a risk of deformation due to depressurisation. At most, the filter should be installed level with the coping. In the event that the filter is installed above the water line, mount a check vent on the return line and an easily accessible check valve on the suction line.

Illustration of installations shown in this document are valid for a filtration system housed in a box sunk to the same level as the pool. Choose a configuration that complies with the recommendations provided above.



Assemble your pool as described in the installation instructions.

Cover the portion of the wooden structure that will be buried with a protective membrane (foundation grade membrane, not supplied).



Back fill around the pool, taking care not to damage the structure.

6.2 Octo + pools

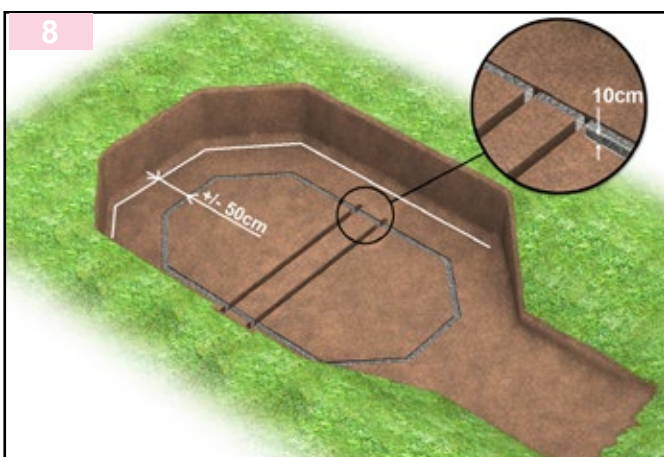

For selection of the site, refer to the instructions at the beginning of this document.

Once the excavation is at the required depth, make sure that the surface is perfectly flat and level. Next, dig a trench to allow drainage under the walls of the pool. Trace the shape of the trench, to assist this process you may temporarily assemble the first row of slats. It should be wide enough to extend beyond each side of the wall once it is built. The cradle trenches are dug as described in figures 22 to 27). If you intend to install the filtration system in a box adjoined to the pool, remember to dig a trench to run the power cable. Similarly, if the filtration system is to be installed at a distance from the pool, dig a trench to accommodate passage of the suction and return lines.

Maximum depth of the excavation:
pool height 146cm = 142cm

IMPORTANT

The structural dimensions and measurements listed have a tolerance of +/- 3% (European standard EN 16582-1). The AFNOR AC P90-321 agreement allows the following deviation in terms of depth:

- For a depth less than or equal to 25m : +/-3cm
- For a depth greater than 1.25m and less than or equal to 1.65m : +/-5cm
- For a depth greater than 1.65m : +/-8cm

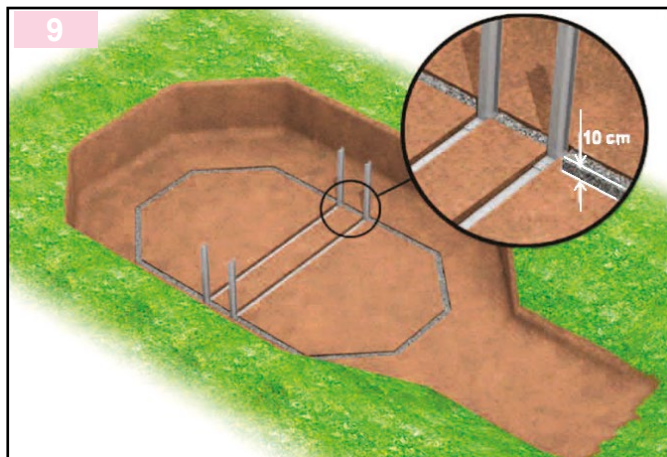

After the trench under the pool wall is dug, fill it to a depth of approximately 10cm using small sized gravel. Make sure that the gravel is well compacted to avoid future subsidence that will impact the pool structure. Finish filling the trench with compacted sand, the filled trench should be level with the ground.

CAUTION!

We strongly recommend that you install the filter below the water line. If the filter is installed above the water line, there is a risk of deformation due to depressurisation. At most, the filter should be installed level with the coping. In the event that the filter is installed above the water line, mount a check vent on the return line and an easily accessible check valve on the suction line.



Assemble your pool as described in the installation instructions.

Cover the portion of the wooden structure that will be buried with a protective membrane.



Back fill around the pool, taking care not damage the structure.

7. ASSEMBLY OF THE OCTO POOL STRUCTURE

Before you begin, familiarise yourself with the nomenclature enclosed in the “Accessories” kit and the exploded view (at the end of this notice) that corresponds to your pool.

Determine the final orientation of your pool, by preference, the skimmers should be oriented so that they are facing into the prevailing winds. Skimmers must be mounted on a side that starts with a type A slat.

While assembling the walls, make sure that each slat is fully engaged before starting on the next.

You may need to use a hammer and a clamp to remedy any slight warping of the slats. Do not strike the wood directly, use the protective brace (provided).

During assembly, check regularly that the walls are level and the 4 diagonals are equal in length.

To avoid the risk of injury or damage to the liner, take care to eliminate any splinters during and after assembly.

If you intend to fit your pool with a counter swim unit, you will need to incorporate the 2 slats that have been machined to accommodate this option.

Fit the 4 half slats (type A - smooth side facing down) together with 4 male/ female slats (type B), grooves facing down, double tongues facing up (see the detail above).

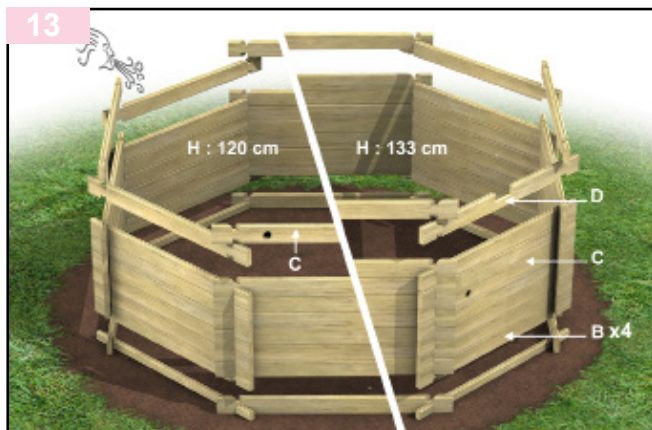
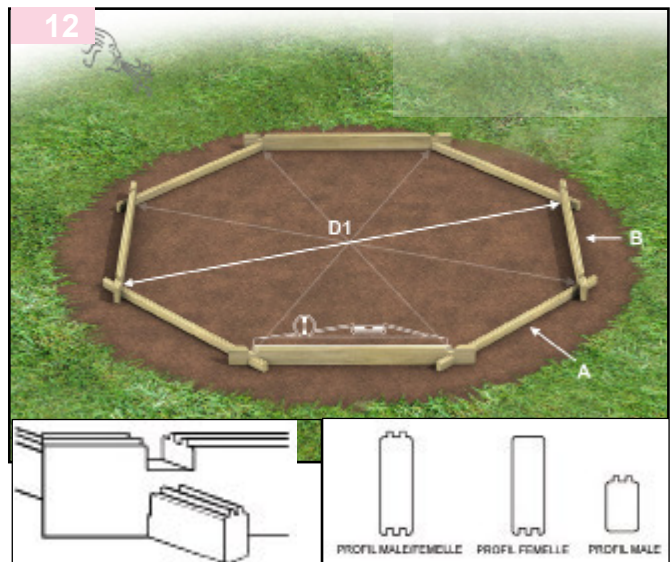

Fit together the remaining slats (type B) taking care with the position the slat that will hold the return fitting (type C) and the machined slat (type D) correctly. The slat that will hold the return fitting (type C) should be positioned over 4 type B slats + 1 type A slat. The second type C slat (with a machined opening) will house the vacuum point. The type D slat is positioned in the last row on the same side described in this step.



At this point, fit the skimmer or filtration unit into the bottom machined slat (type D).

15

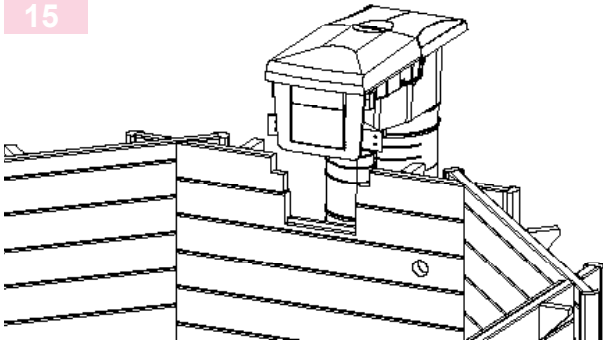

16



In the case of skimmer, fit the top machined slat (type E) over the type D slat, and continue around the pool with 3 type F slats and 4 half-slats (type G) as shown

IMPORTANT

The structural dimensions and measurements listed have a tolerance of +/- 3% (European standard EN 16582-1). The AFNOR AC P90-321 agreement allows the following deviation in terms of depth:

- For a depth less than or equal to 25m : +/-3cm
- For a depth greater than 1.25m and less than or equal to 1.65m : +/-5cm
- For a depth greater than 1.65m : +/-8cm

17

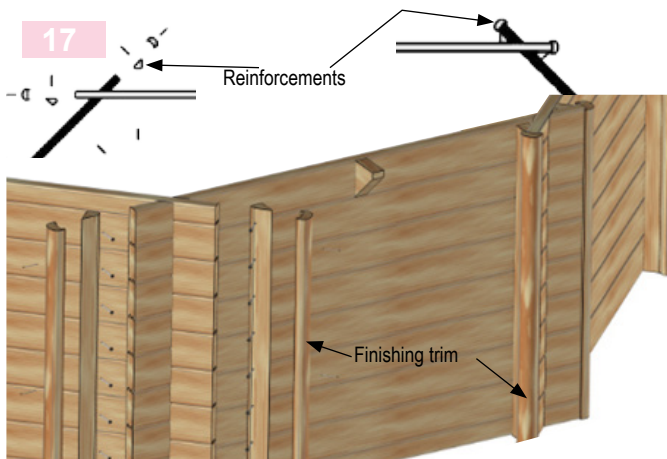

To fasten the reinforcements from the outside: insert screws the 100 mm from the corner. To fasten the reinforcements from the inside: Position the screws 85 mm from the corner. Use one screw per slat in both cases. Paint the ends of the slats in the corners with a wood sealant to prevent warping over time.

18

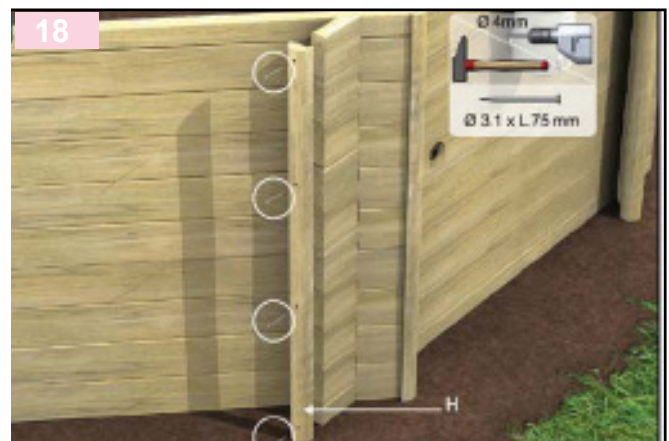

The reinforcements should be fixed in position before mounting the trim.

Attach the finishing profiles (type H) to the exposed edge of each wall using 4 equally spaced SS rivets (3.1x75 mm) inserted into holes pre-drilled in the axis.

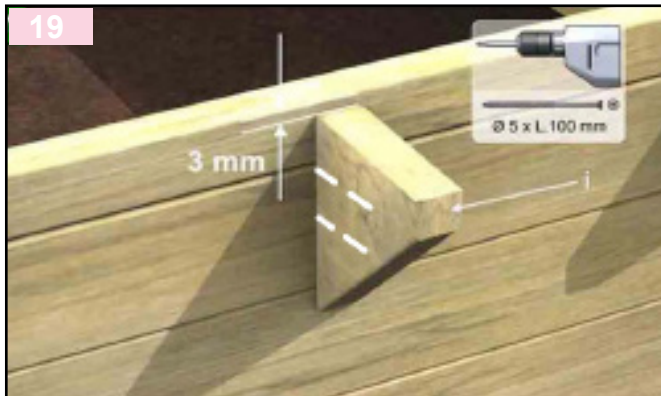

The wooden corbels will support the coping modules that will be mounted after the pool is filled. Pre-drill the wall from inside the pool then attach each wooden corbel (type I) using 2 screws (5x100 mm sachet I) taking care to position them 3 mm below the top of the structure. Remove any splinters that may have been raised during this process.

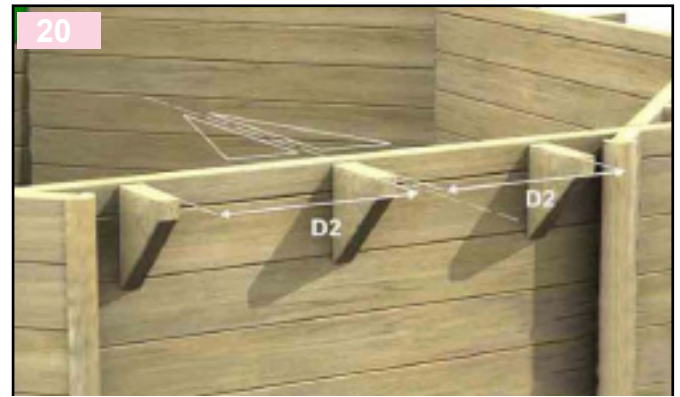

There are 3 wooden corbels per side (except the side holding the skimmer). Position 1 wooden corbel in the centre of the slat, the other 2 equidistant on either side of it (distance $D2 = 58\text{cm}$).



Mount 2 wooden corbels on the wall holding the skimmer, they should be 75.5 cm apart and equidistant from the skimmer axis.



Screw a mounting plate to the top of each wooden corbel (corbel kit). Make sure that each plate is flush with the top of the walls.

CAUTION Check that the structure is correctly assembled before mounting the liner locking track. Correct any imperfections before continuing.

To do this:

- use a spirit level to check that the structure is horizontal around the entire periphery.
- check that the 4 diagonals are equal in length. Fix any imperfections before continuing.

The liner locking track should be flush with the top of the wooden structure. Before mounting the liner locking track, pre-drill using a $\text{Ø } 3\text{ mm}$ drill bit. Avoid over tightening, this could cause the screws to break through the track.

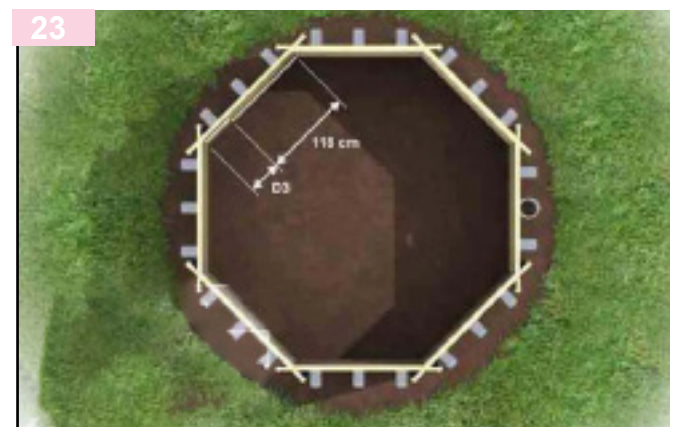

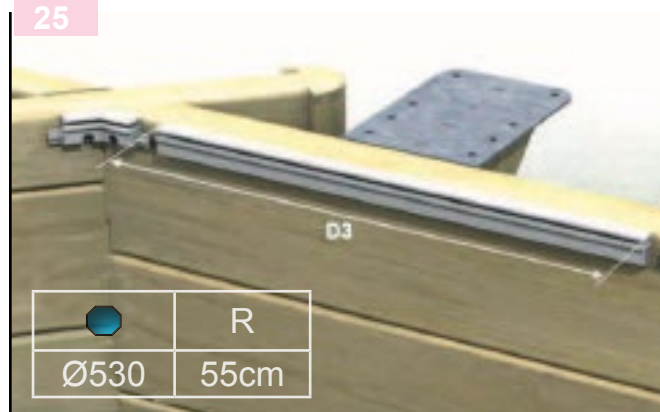
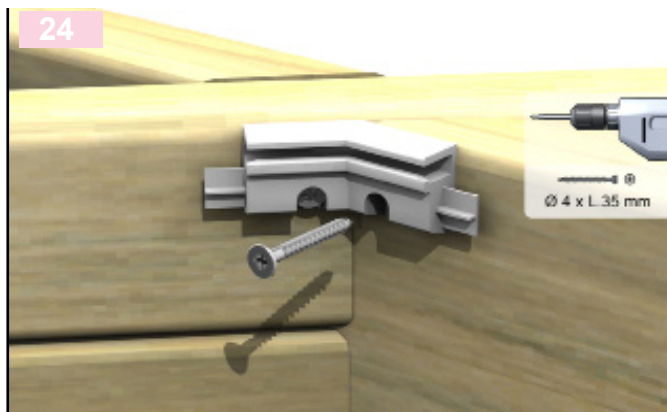

Mount a corner junction piece (junction+corner blister pack) in each corner using 2 SS screws (bag E) inserted through the notches intended for this purpose. Make sure that these parts are flush with the top of the pool wall. Each wall will take a 1.18 m length of track and an additional length that will need to be trimmed to size.

Prepare the 8 additional pieces of track. Before making the cuts, check that the total length of the track is equal to the distance between two corner pieces less 2 mm to allow for the joining pieces. Make sure that the cuts are straight and clean. Deburr the cuts using the fine grain file.

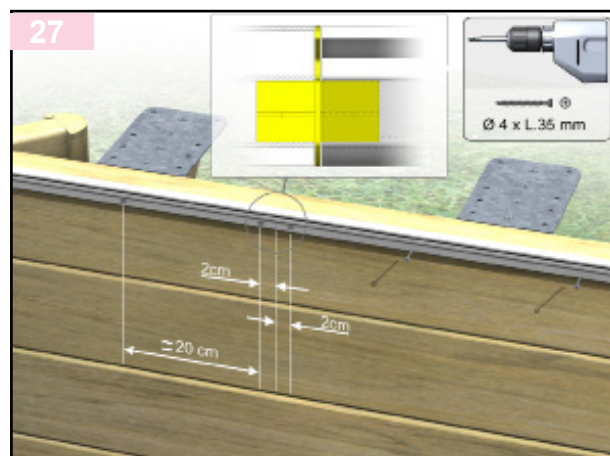
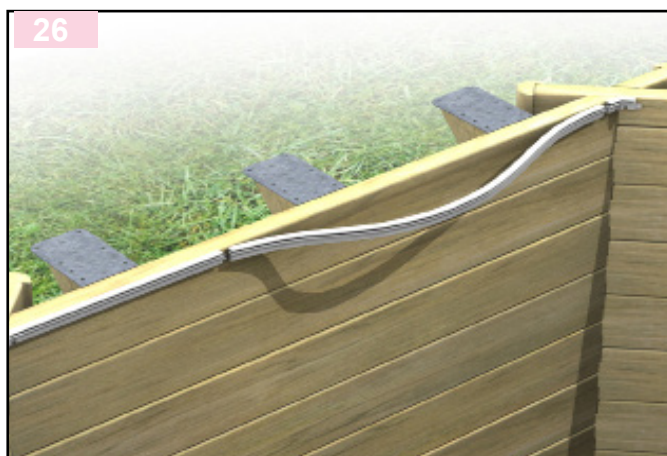

Fit the long section into the corner piece. Bend the track to facilitate fitting onto the junction piece. Hold the track in position using a screw 2 cm from each end. Then complete attachment of the track by inserting screws at 20 cm intervals.

7.1 Laying the underlay



▶ IMPORTANT The ground underneath the underlay should be absolutely flat and free of any bumps or rough areas.

Because of the pressure exerted by the water, even the smallest bump will be visible underneath the liner. After clearing the ground, spread a layer of sand mixed with cement (1 part cement to 7 parts sand) over the floor of the pool and compact it. This layer should be no more than 1 cm deep. (The sand and cement are not supplied). Unfold the underlay in the pool taking care to line it up correctly with the corners. Smooth out any wrinkles. The underlay will be slightly smaller than the pool structure.

8. ASSEMBLY OF THE OCTO+ POOL STRUCTURE

The pool structure is mounted in two stages:

- Stage 1, excavation of the site and installation of the cradles designed to reinforce the lateral walls. A cradle comprises a cross beam, vertical posts and metallic plates to be bolted together.
- Stage 2, assembly of the wooden structure and fitting of the additional items (liner, coping, etc.).

We recommend that the pool structure be assembled by two people. Before you begin, familiarise yourself with the nomenclature page (enclosed with the Accessories kit) and the main exploded view (at the end of this document) that corresponds to your pool.

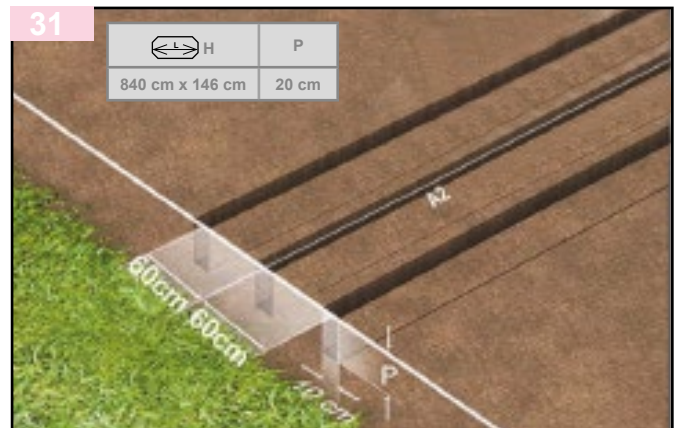
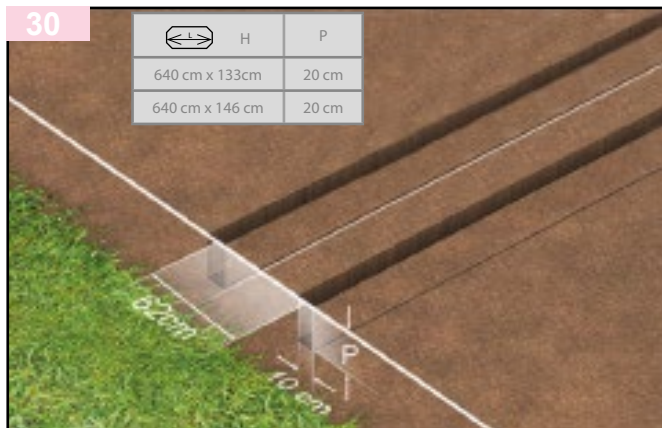

You will need to dig shallow trenches to hold the cradles. Make sure that these are parallel to each other and to the A2 axle. The number of trenches required will depend on the pool model, refer to the illustrations corresponding to your pool. Trenches should be regular and sized to hold the cradles in the right position.



Lay the cradle components out beside the trench and fit them together (using the cradle kit).

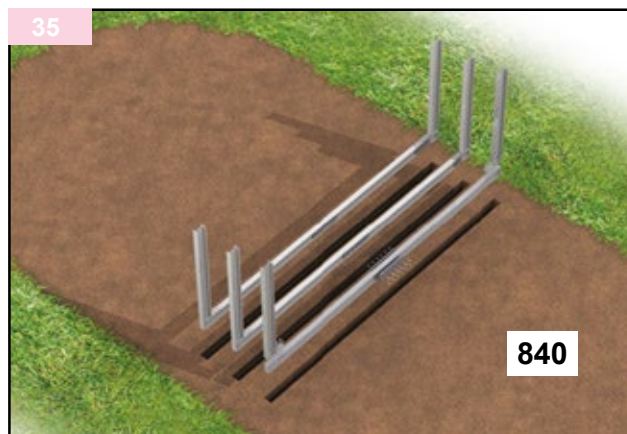
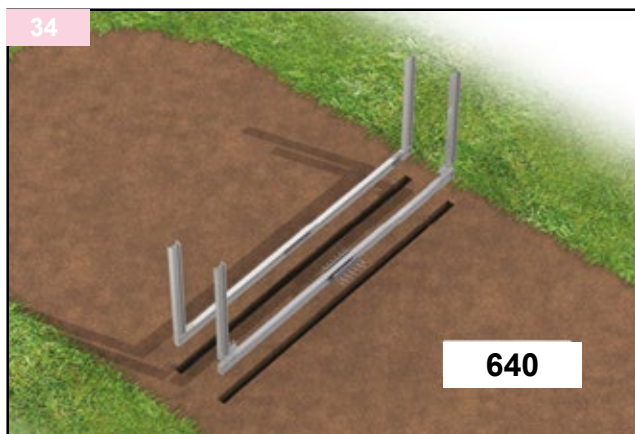

Once the cradles have been assembled, place them in the trenches and block them in position using wet compacted sand if necessary. During this operation, check that the cradles are level, straight, aligned and parallel. Fill the trenches with wet, compacted sand. Important ! Make sure that the cradles are buried to the correct depth.

Recommendations and advice:

- Before beginning assembly, identify the various slat types with reference to the exploded view at the end of this document.
- Establish the final orientation of your pool, the skimmer should be oriented facing into prevailing winds. The skimmer should be mounted on a side that starts with a type A slat.
- While assembling the walls, make sure that each slat is fully engaged before starting on the next.
- You may need to use a hammer and a clamp to remedy any slight warping of the slats. Do not strike the wood directly, use the protective brace (provided).
- During assembly, check regularly that the walls are level and the 4 diagonals are equal in length.
- To avoid the risk of injury or damage to the liner, take care to eliminate any splinters during and after assembly.
- Please refer to the various illustrations provided in this document.
- If you intend to fit your pool with a counter swim treadmill, you will need to incorporate the 2 slats specially prepared to mount this option.

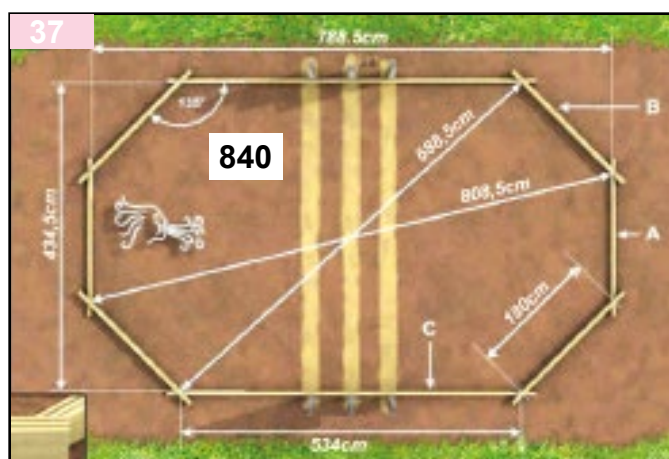
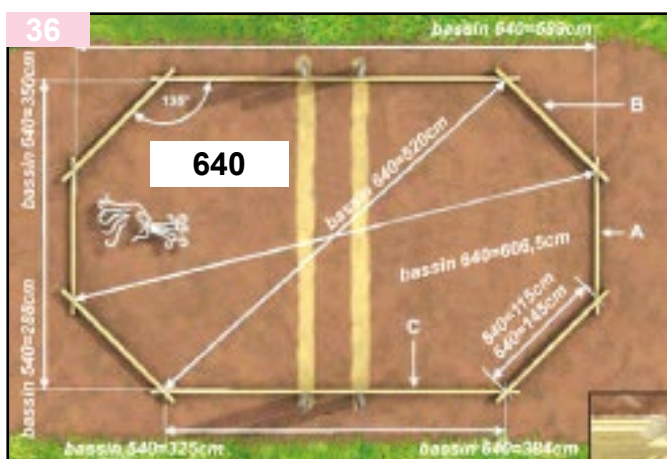

Fit 2 type A half-slats and 2 type C half slats together with 4 type B wall slats according to the illustration above. The male side (double tongue) should face upwards (see the detail below).

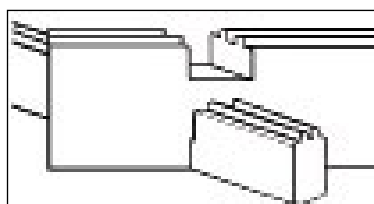

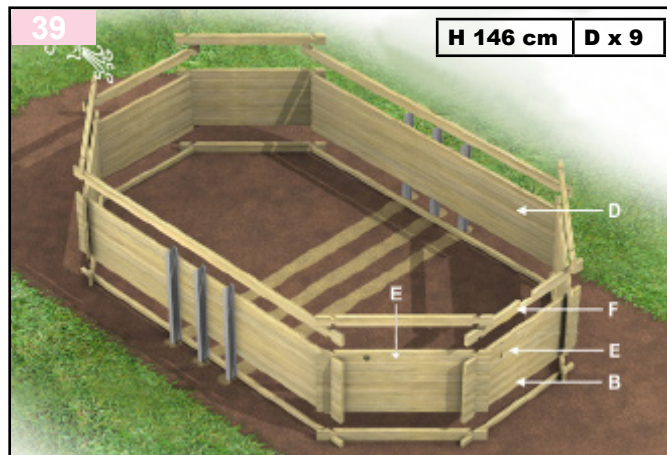
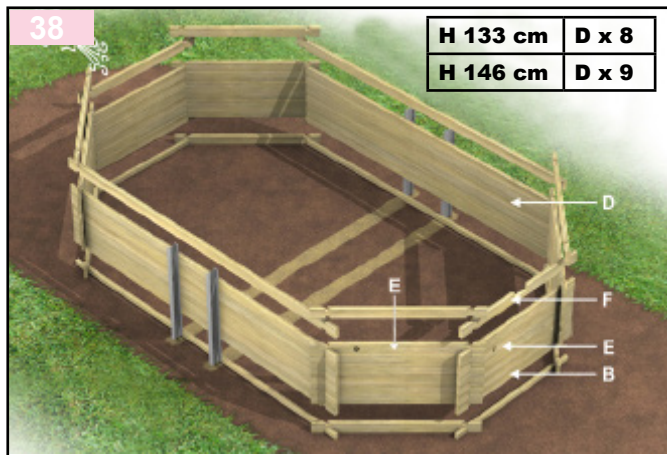

Fit the remaining slats together using type B slats on the short sides and type D slats on the long walls. Take care to correctly position the machined slats (type E) that will hold the return and vacuum fittings, the bottom skimmer slat (type F) and, if necessary, the 2 optional slats from the counter swim unit kit. (Refer to the exploded view at the end of this document for the position of these slats). The slat that will hold the return fitting (E) should be positioned above 4 type B slats + 1 type A slat. The type F slat should be located on the same side in the last row of this step. The type E slat that houses the vacuum point in Odyssea models should be positioned at the same level as the bottom skimmer slat (F).

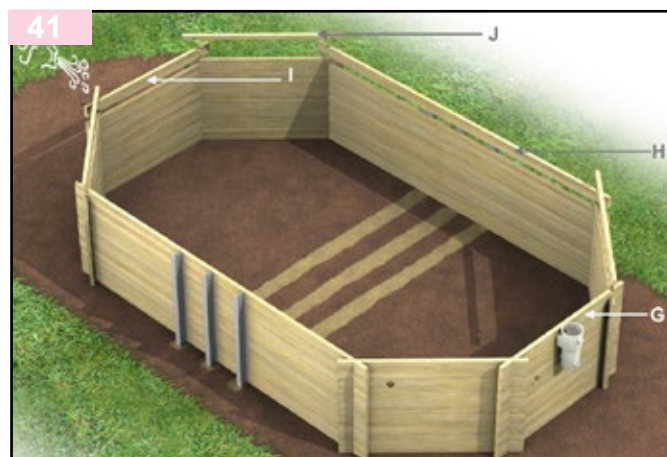
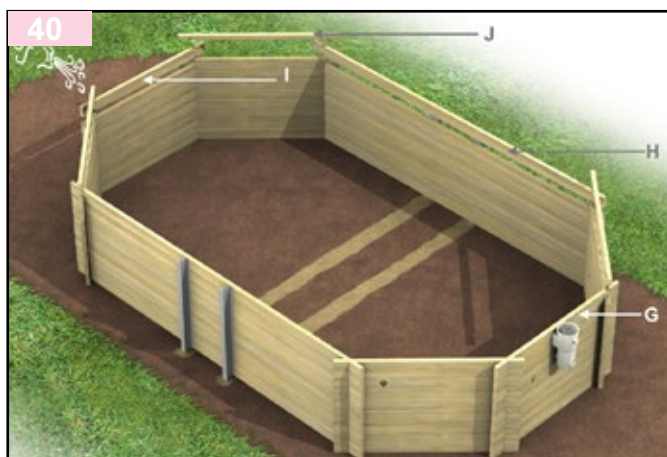

At this point, fit the skimmer into the machined slat (F). Slot the top skimmer slat (G) over slat F and continue around the pool, fitting 2 type H slats, 1 type I slat and 4 type J half-slats into position as shown.

IMPORTANT

The structural dimensions and measurements listed have a tolerance of +/- 3% (European standard EN 16582-1). The AFNOR AC P90-321 agreement allows the following deviation in terms of depth:

- For a depth less than or equal to 25m : +/-3cm
- For a depth greater than 1.25m and less than or equal to 1.65m : +/-5cm
- For a depth greater than 1.65m : +/-8cm

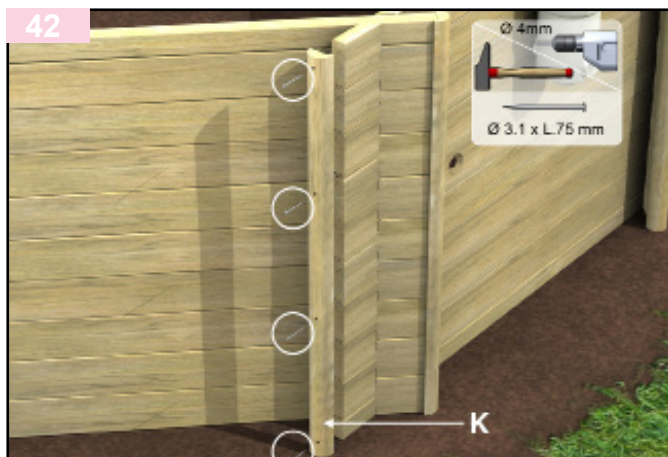

Using a brush, paint the ends of the slats in each of the four corners with a stabiliser to prevent their deformation over time. Attach a decorative trim (type K) to the end of each wall using 4 3.1x75 mm screws (bag L) inserted through holes pre-drilled at regular intervals along the axis.

Working from the outside, screw the metallic posts (pre-drilled) onto the wooden walls using 6x40 mm screws from bag C. Check their verticality. Position two decorative profiles (Q) on either side of each post and fasten them together using 3 5x70 screws (bag C) as shown.

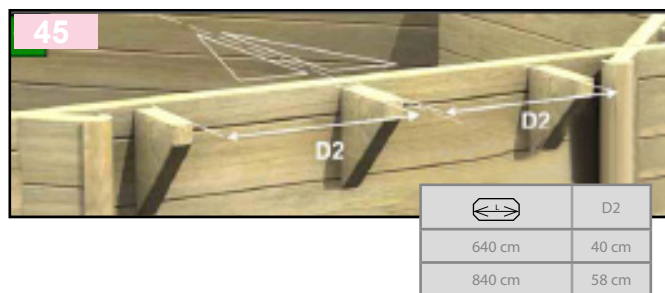
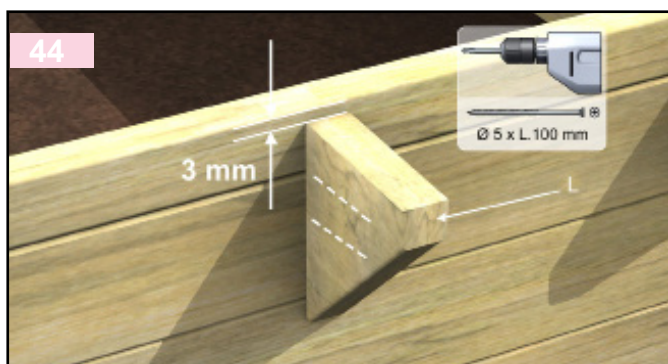

The wooden corbels are designed to seat the coping modules that are installed after the pool is filled. Pre-drill the wall, then, working from inside the pool, fasten each coping corbel (L) in position using 2 5x100 mm screws (bag I), taking care to ensure that each bracket is 3 mm beneath the top of the pool structure. Check that each coping corbel is plumb.

The short sides of the 640 and 840 pools should be fitted with 3 coping corbels, except for the skimmers side where 2 coping corbels should be installed.

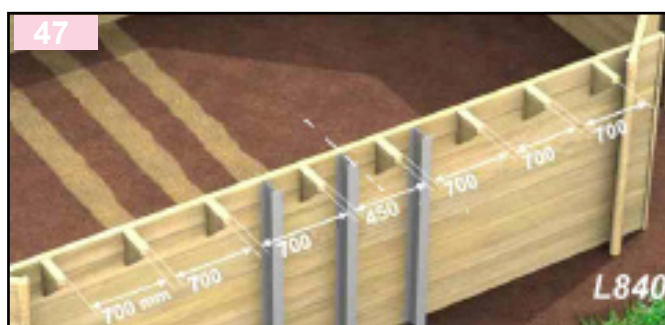

Attach the corbels along the lengths as shown.

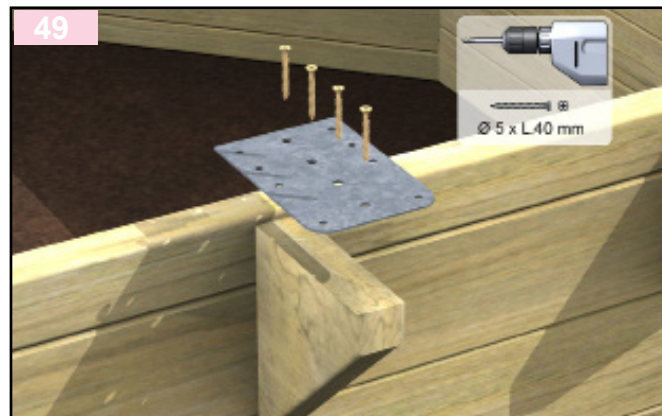
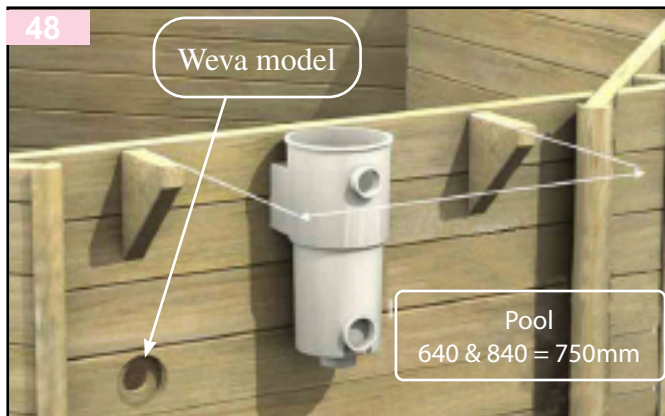

On the wall holding the skimmer, position 1 coping support bracket on either side of the skimmer equidistant from the skimmer axis as shown.

Mount an anchoring plate (coping support bracket kit) on each support bracket. Make sure that each plate is flush with the top of the pool structure. Bevel the holes in the plate before fixing the plates in position.

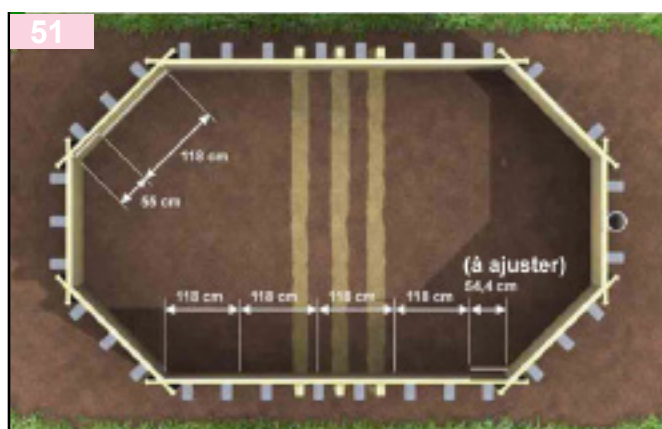
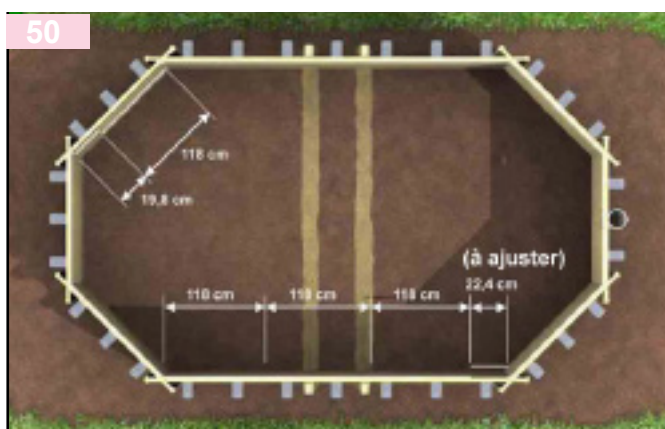

IMPORTANT !

Before you begin to install the liner locking track, check that the structure was correctly assembled.

- Using a spirit level, go around the entire structure checking that it is horizontal.
- Check that the four diagonals are equal in length.
- Correct any defects.

Recommendations:

- The liner locking track should be fitted such that it is flush with the top of the wooden structure.
- Use junction pieces between each liner locking track section.
- Check the length of liner locking track required before trimming it.
- Pre-drill the walls using a Ø 3 mm drill bit and fix the liner locking track in position.
- Avoid over tightening, this could cause the screws to break through the track.

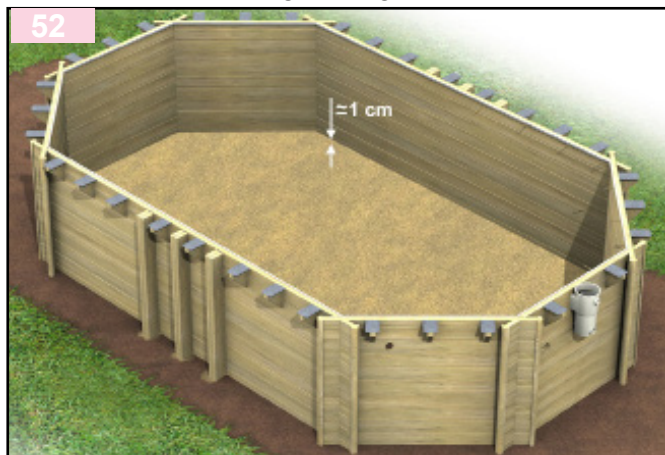

IMPORTANT !

The ground underneath the underlay should be absolutely smooth flat and free of any foreign bodies. Because of the pressure exerted by the water, even the smallest bump will be visible underneath the liner. After clearing the ground, unfold the underlay in the pool taking care to line it up correctly with the corners. Smooth out any wrinkles.

9. APPLYING THE GASKETS

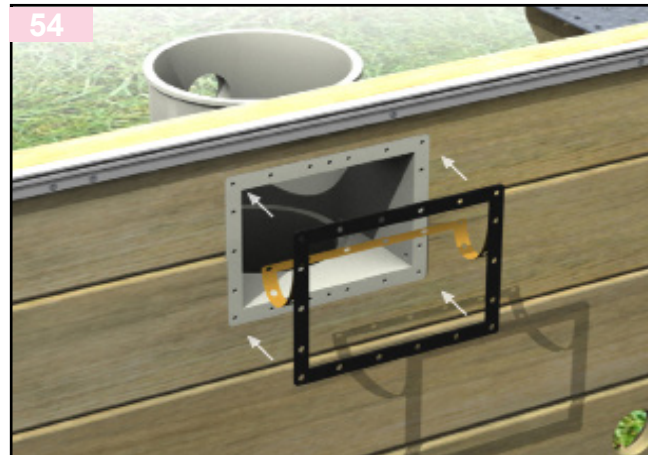

Before fitting the liner, glue one of the 2 rectangular self-adhesive gaskets (pool fitting skin pack) around the mouth of the skimmer or filtration unit. Make sure that the holes in the gasket are correctly aligned with the holes in the skimmer.



From the pool side, insert return fitting throughwall flange (pool fitting pack) into the opening in the pierced slats. Fix it in position using countersunk self-tapping 3x25 screws. Fit a self-adhesive gasket to each throughwall flange. Screw carefully by hand to avoid damaging the wood.

10. LAYING THE LINER

IMPORTANT !

The ideal temperature for laying liner is between 18° and 25°C. Outside this range, the liner will be either too rigid or too pliant and will be difficult to fit. On very hot days, lay the liner early in the morning. During cold weather (less than 18°C), store the liner somewhere warm for as long as possible to increase its suppleness and do not take it out until the last minute.

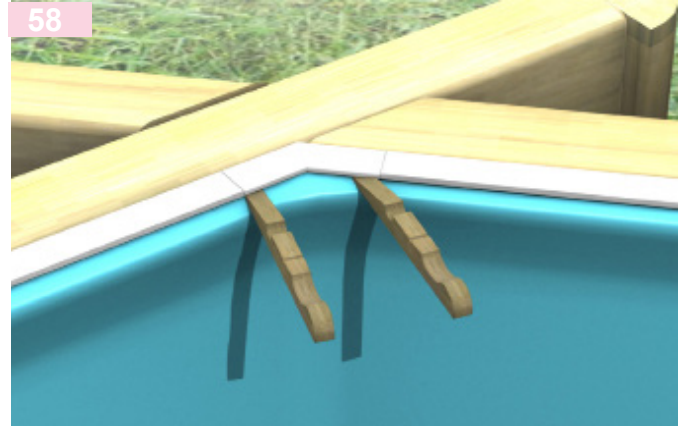
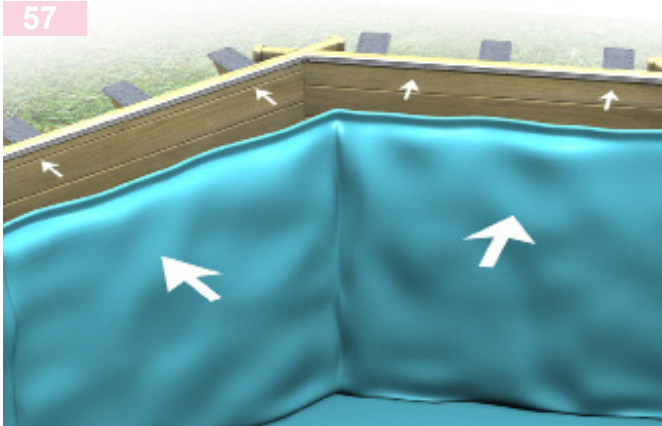

Place the liner in the centre of the pool and unfold it. When it is unfolded, the liner will form either an octagon or an elongated octagon on the ground, depending on the pool model. Line the corners up with the corners of the pool structure. Working in bare feet from inside the pool, fit the liner lip into the liner locking track, continue around the pool.

CAUTION!

The vertical seam that joins the band that covers the walls should not be on the wall that holds the skimmer. If this is the case, turn the liner.

While fitting the liner, insert wooden half pegs (provided) in the liner locking track to hold it in position in the corners and at regular intervals around the periphery. This will help position the liner and stop it from slipping in the track. Keep the pegs in position until the pool has been filled with water. Make sure that the bottom corners of the liner correspond to the corners of the pool structure. You will note that the liner is slightly smaller than the structure, this is normal and necessary to ensure correct tension on the liner after the pool has been filled with water. The liner is approximately 1% smaller around the periphery, height is approximately 5% shorter. Make sure that the liner is spread out over the entire surface of the pool. Leave the liner as is until the warmth of the sun eases out the creases caused by folding (this will take a few hours).

CAUTION!

In the event that you need to move the liner, do not slide it in the track. Take it out of the track by pulling upwards on the lip and reposition it. Sliding the liner in the track can cause it to tear just below the lip (this type of damage will not be covered by any guarantee).



Once the liner has been hung and is correctly positioned, fill the pool with 2 cm of water. Push any creases towards the walls smoothing out the liner as much as possible. This operation will not be possible if the pool is empty or overfilled (contains more than 2 cm of water). Once the liner is correctly hung and positioned and creases have been eliminated, continue filling the pool until the water level is 10 cm below the first pool fitting.

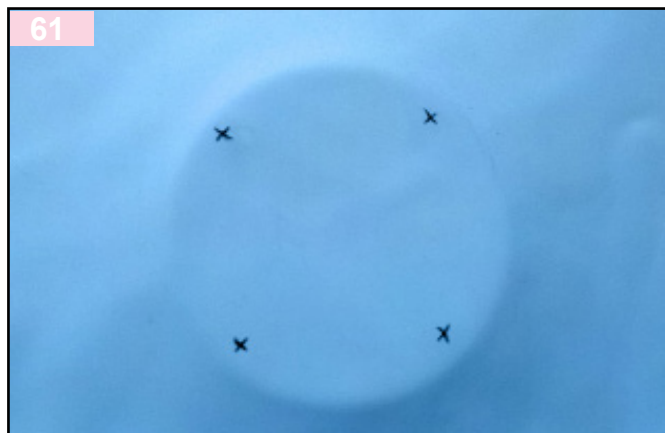

Stick the self-adhesive gaskets to the return fitting and vacuum fitting flanges. Locate the four holes in the throughwall flange and mark them.



Screw the flange (fitted with its self-adhesive gasket) into place using the countersunk SS screws M5x16 from the pool fitting skin pack. Tighten the screws alternately to ensure a leaktight fit. Hand tighten, over tightening could damage the flange. Cut out the liner inside the return fitting flanges.

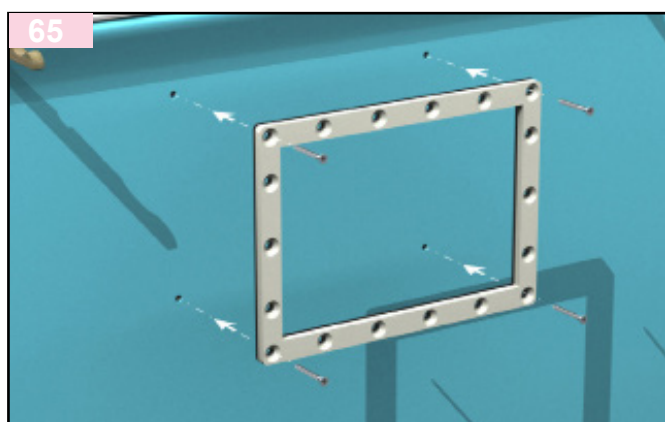
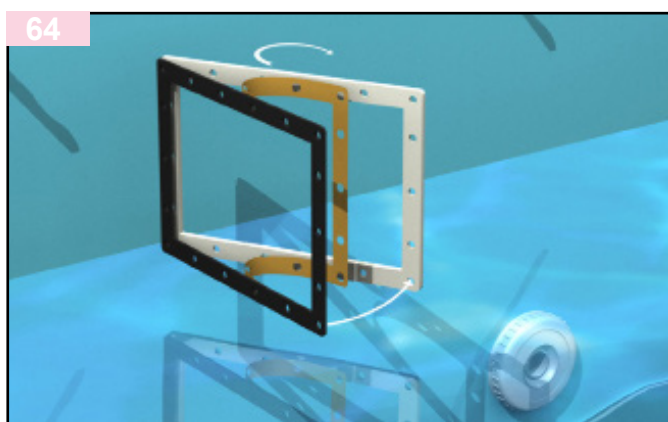

Glue the second skimmer gasket to the interior surface of the skimmer. (The inner surface had sharp edges while the outer surface has rounded edges). Locate the 4 corner holes of the mouth and mark them with a pen. Position the flange such that its corner holes are aligned with the points marked in pen.

Use a small screw driver or punch to pierce the liner at the 4 points marked and fix the flange in position with the gasket against the liner. Once the 4 corner screws are in place, continue, inserting a screw through each hole. Avoid over tightening, this could deform the flange. Tighten the screws alternately to ensure an even and leaktight fit.

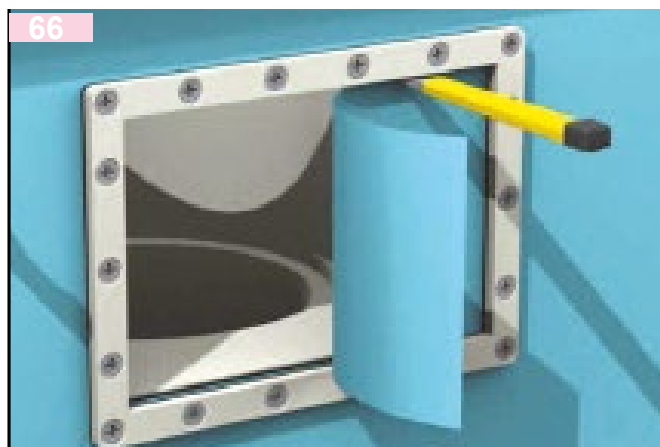

Cut away the liner inside the flange. Keep the offcuts for future repairs. In the case of skimmers, clip the weir into place, smooth surface facing the pool. The weir should be able to swing freely. Mount the skimmer face plate. The skimmer basket is passed through the skimmer mouth, swing the weir towards the pool to make space.

Place the lid on the skimmer. (these parts can be found in the Pool Fitting skin pack).



Screw the multi-directional eyeball assembly into the return fitting body. The eyeball should be pointed left to facilitate the flow of water necessary for efficient filtration. (Prior to assembly, apply a layer of silicon grease to the eyeball and its housing to facilitate its movement and subsequent removal for winterizing).

11. INSTALLATION AND COMMISSIONING OF THE FILTRATION GROUP

IMPORTANT !

The pump power supply must be protected by a 30 mA RCD located upstream of the installation.

CAUTION !

We highly recommend that the filter be installed below the water line. Above the water line, a vacuum could form and cause deformation of the filter. The maximum acceptable height is level with the coping. In the event that the filter is installed above the water line, a check valve must be installed on the return line and an accessible check valve must be installed on the suction line (these items are carried by all pool specialist stores).

11.1 Installation of the filter

The various components of the filtration system are listed in the following.

The installation described here is a basic installation, the kit provided allows the filtration group to be installed 3.5 m from the pool in accordance with the safety standards in effect in France. You may need to modify the lengths of the tubes and pipes to suit the lay of your land, the installation configuration chosen (in-ground, partially in-ground or above-ground), the type of plant housing and other installation limitations.

For the installation, refer to the following sand filter installation instructions as well as the pump operating instructions. Study the drawing of the filtration system that shows the various elements and connections.

CAUTION !

The various electrical components of the filtration system, as well as any other electrical devices, must be wired in according to the standards in effect in the country of installation, the C15-100 standard in France.

Do not hesitate to call on a professional to ensure the compliance of your installation.

Precautions and advice

- Barrel unions (isolating valves) should be tightened by hand only, no tools are required. In fact, excessive tightening can damage the threading or twist the seals leading to leaks.
- Wrap 3 or 4 turns of sealing tape around connections that have no seals.
- Only the collar clamps (cerflex type) need to be tightened with a crosshead screwdriver.
- Do not over tighten.
- Before tightening, do not forget the rubber bands designed to cover the collar clamp.

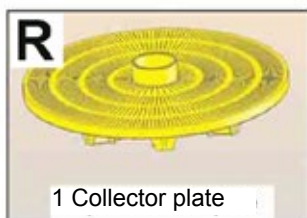
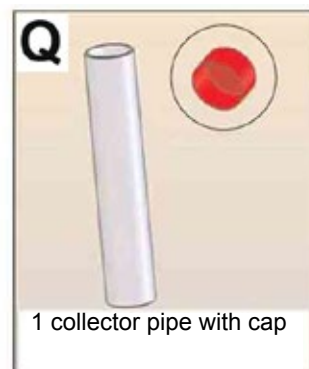

Description	Flow rate (in M/h) without directional return jets	Filter diameter (in mm)	Sand	Filtration surface area (m ²)	Volume filtered in 24 h
Filtration	7.9	500	3X25 kg	0.2	189.7

Ref	Description	Ref	Description
A	Module (descente rigide) aspiration	L	Pressure gauge
	Semi-rigid pipe, 45 mm	M	Waterproofing tape (teflon)
C	Return module (rigid descending pipe)		
D	Rubber collar + clamp	O	Return fitting
E	Pump/ filter connecting pipe	O1	Return fitting throughwall flange
F	Suction insulation module	O2	Return fitting gasket
G	Pump	O3	Return fitting flange
I	Skimmer	O4	Front plate with directional jet
I1	Skimmer lid	P	Drain plug + o-ring
I2	Skimmer basket	Q	Collector pipe with plug
I3	Skimmer gasket	R	Collector plate
I4	Skimmer screws 5.5 x 25	S	Lid + 6-way valve
I5	Skimmer flange	T	Filter base
I6	Skimmer weir	U	Pump base
I7	Skimmer flange trim	V	Lid ring
I8	Skimmer body	W	Lid ring seal
I9	Adjustment plate with screws	X	Diffuser
J	Union under the skimmer	Z	Filter tank
K	Return line isolating module (valve)		



11.2 Mounting the rigid descending pipes

CAUTION !

When assembling the various connections use Teflon and check that o-rings and seals, if any, are in place.



Wrap Teflon (enclosed in the Accessories pack) 4 or 5 times around the elbows of the rigid descending pipes C and C¹, screw them onto the exterior outlets of the return fitting and vacuum point (in the case of the Odyssey model) nozzles, do not forget to use the o-rings provided in the pool fittings pack. Tighten by hand to avoid crushing the o-ring.

Next, screw the upper union of the rigid descending pipe, C, onto the return fitting elbow.



Screw the rigid descending pipe C onto the return fitting nozzle elbows. Do not forget to check that the o-ring is in position.



Wrap Teflon around the 2 threadings on the J unions and screw them into position underneath the skimmer.

Screw the compression union heads into position under the skimmers. Cut the pipes at the mark corresponding to the height of your pool. Chamfer the cut slightly to facilitate insertion of the pipe into the compression union. Check that the pipe is inserted fully, then tighten the green ring making sure that the connection is leak tight.

11.3 Assembly of the filter



Check that the drain plug and o-ring are in position. Hand tighten only.

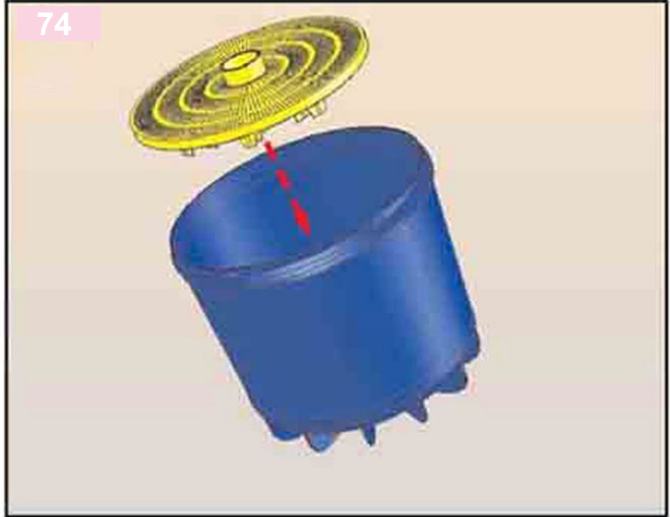

Position the collector plate in the bottom of the filter tank. Check that it is lying flat and level.

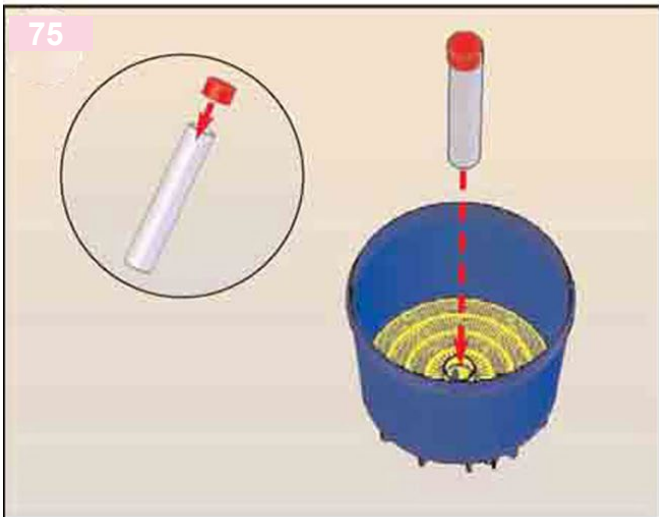

Top the collector pipe with its protective cap and insert it into the hole in the middle of the collector plate.

Carefully pour the sand into the filter and, using your hand, spread it out evenly.

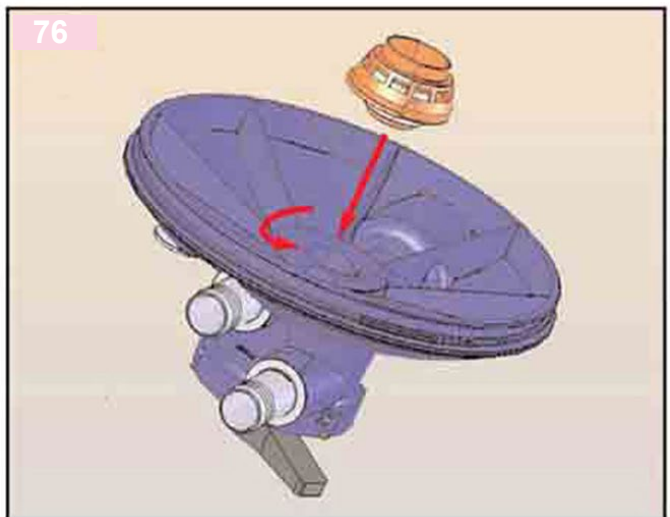

Insert the diffuser into the lid and lock it in position by turning it anti-clockwise.



Installing the pressure gauge: Place the o-ring in its groove in the cover.



Position the pressure gauge correctly and place it in its housing.

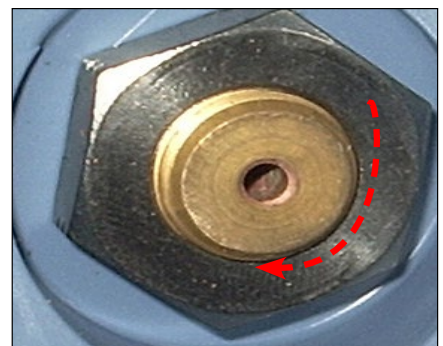

Working from underneath the cover, tighten the bronze nut by hand, then moderately using a 22 tube wrench. Take care not to damage the o-ring.

Mount the correct union on each of the 3 ports on the filter lid:

Lid port	Solvent union
Waste	Hose tail, 38 mm
Suction	Hose tail 45 mm
Return	Tapped sleeve 1"1/2 x male solvent 50 mm.

CAUTION The depth of the sand should not be more than 2/3 the height of the filter tank.

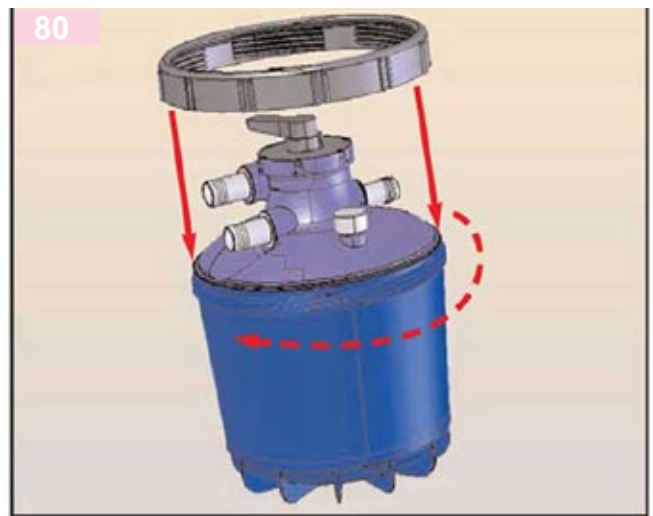
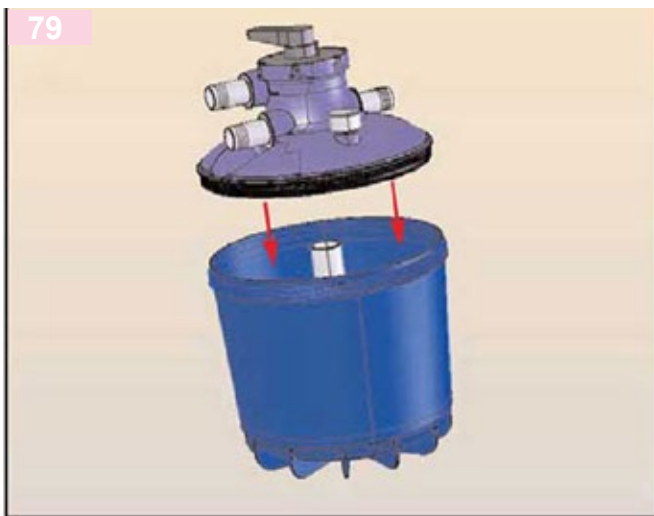
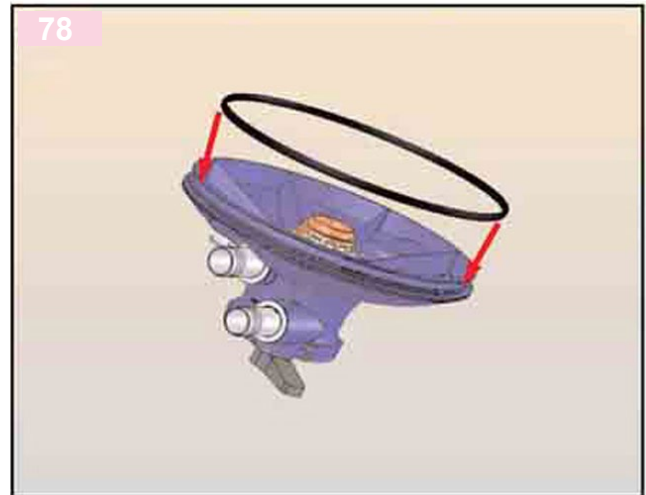

Check that inside surface of the upper portion of the tank is clean.

Remove the cap from the collector pipe. Apply silicon grease to the upper inner portion of the tank to facilitate fitting of the lid.

Place the lid flat over the tank and push down evenly to slide it into the tank.

Once in place, the lid should meet the top of the tank and the o-ring should not be visible.

Fasten the lid to the tank using the lid locking ring (V).

Tighten a quarter turn only.

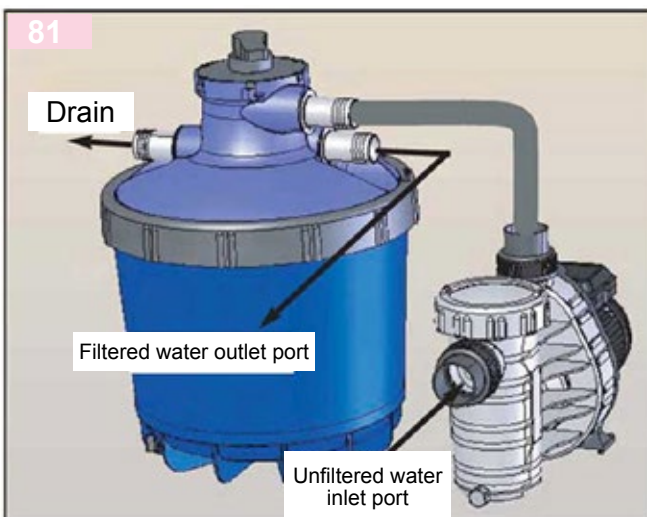

CAUTION An incorrectly fitted lid could lead to:

- Sand being expelled from the the return fitting.
- Water escaping from the the waste port.
- Leaking from the tank.
- In filtration mode, it is normal for a small amount of water to run from the waste port.

11.4 Collector and pump/filter module

82



Mount the pump on its base, then connect the assembly to the filter base. Ensure that the orientation of the assembly will facilitate subsequent installation of the semi-rigid pipes.

Screw the collector module (F) onto the pump inlet. Do not forget the o-ring enclosed in the pump pack.

Screw the screwed union from the pump pack onto the pump outlet. (Do not forget the o-ring).

Cut a section of tube to length and connect it as illustrated between the pump outlet and the 6-way valve.

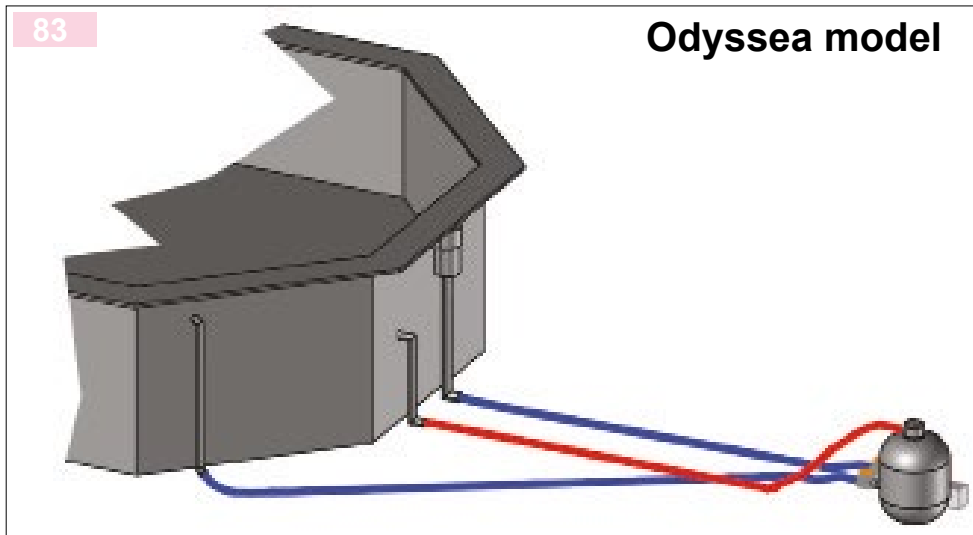

11.5 Connecting the pipes

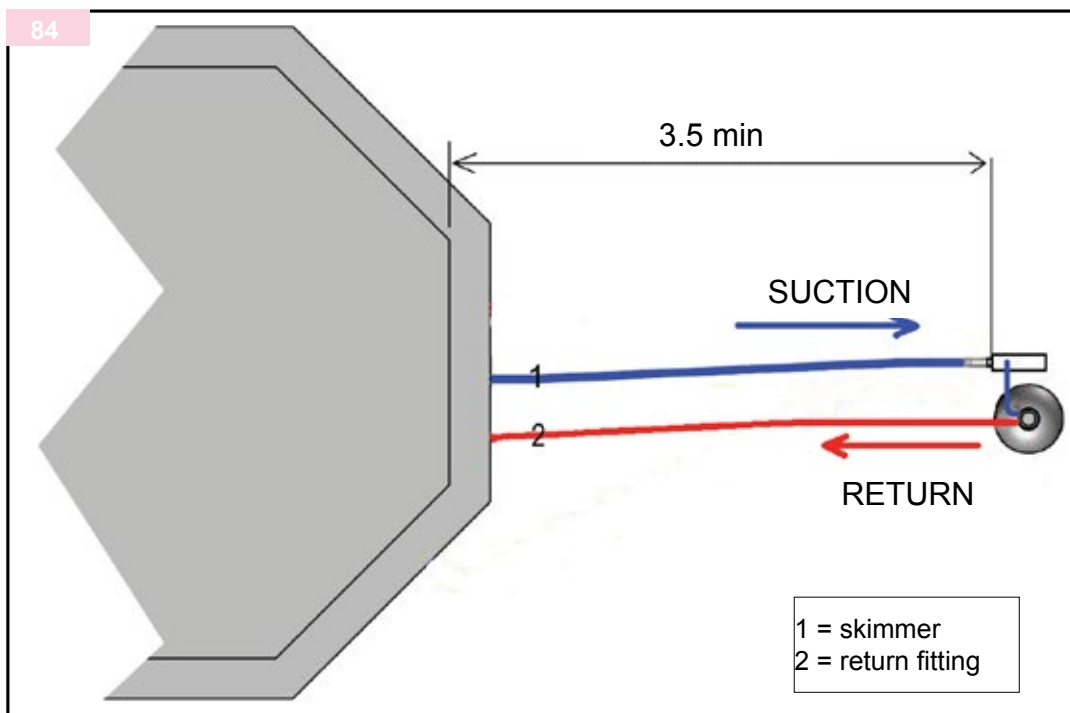

Connect the tubes between the rigid descending pipes and the filtration group as illustrated in the diagram below. The filtration kit supplied with your pool is sized for installation of the filtration group 3.5 m from the pool, pipe and tube lengths are indicative. They will need to be modified to adapt to your pool configuration.

Tip: Use silicon grease or soapy water to facilitate insertion of the pipes.

Before connecting the pipes, thread 2 rubber sleeves on either end to protect the Torro clamps after they have been tightened.

11.6 Filling the pool

! TIP If the pool is to be installed in-ground, check for leaks before burying the lines and connections.

Check that the valves are all closed and fill the pool until the water level is 2/3 of the way up the skimmer mouth.

Check the various pool fittings for leaks. Make sure that the liner is properly hung, particularly in the corners. If the liner becomes disengaged, it will probably be necessary to empty the pool in order to rehang it.

11.7 Filling the hydraulic circuit with water

Open the various valves to fill the hydraulic circuit with water. Check for leaks.

Before starting the pump (the pump should never be allowed to run 'dry') check that the pre-filter has filled with water. If necessary, open the pre-filter and fill it and the skimmer line with water to facilitate priming of the pump.

Turn the 6-way valve to Back wash (to clean the filter before starting filtration).

Start the pump and check the circuit for leaks.

12. COPING

12.1 Installation of the coping - Weva

12.1.1 Octo and Octo + pools

Note the distribution of the various modules constituting the coping of your pool, arrange them with their groove side facing up.

Set the coping such that there is an approximately 25 mm overlap over the pool (measured from the pool wall). Take the time to check that the coping modules are correctly aligned. The gap between outside and inside modules can vary from 2 to 5 mm.

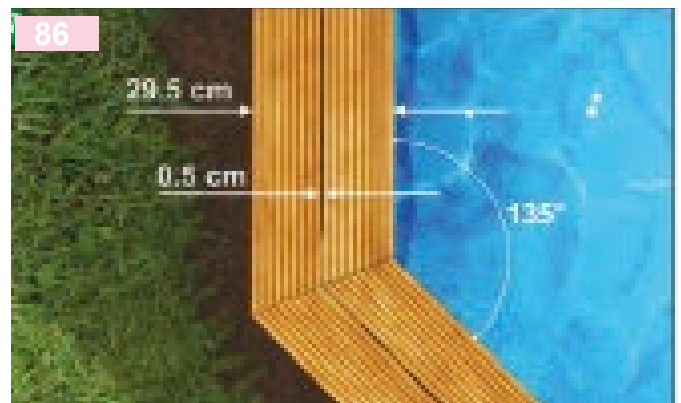
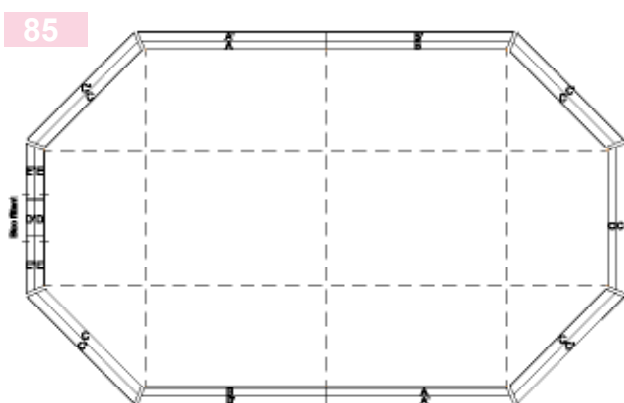

Pool model	A or B	A' or B'	between A and B	Sand filter	
				C	C'
530				1905	2029
+640	1971	2033		1550	1667
+840	1971	2033	1500	1905	2029



Using wood screws (bag G or H), fasten the coping modules to the corbel mounting plate as shown above. Pre-drill to facilitate installation. As the installation proceeds, ensure that the coping modules are properly aligned.

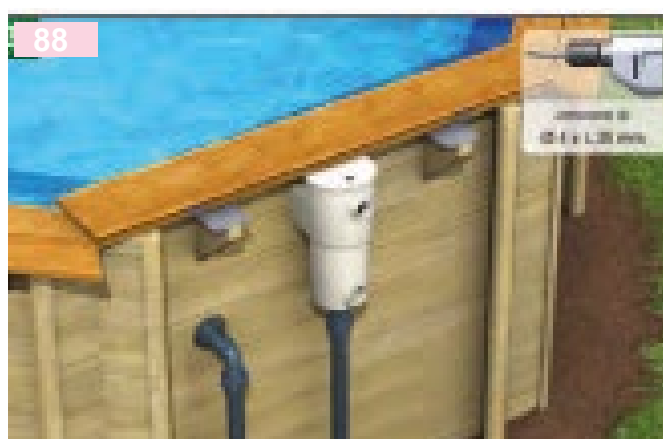

In the case of skimmer, the outer coping module is attached to the inner module by means of 2 hinges (bag A). It is therefore not fastened to the corbel mounting plate. This hinge provides access to the skimmer. Install a lock to allow the outer coping module to be secured.

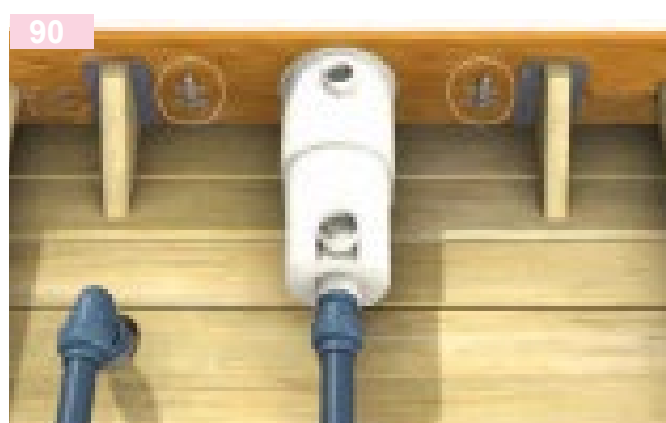

Fasten a metallic plate in position in each corner using wood screws (bag G). Install the latches (bag N).

13. INSTALLATION OF THE LADDERS

13.1 Stainless steel ladder

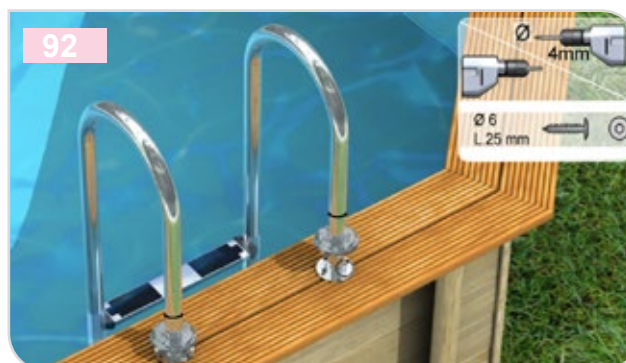

Assemble the various parts of the stainless steel ladder referring to the installation instructions provided. When mounting the hand rails, do not forget the two rubber seals that will be used to hold the decorative escutcheon plates in position.

Position the ladder in the pool on the coping module of your choice (but not against the wall housing the skimmer), remember that it should be opposite the wooden ladder.

Adjust the position of the ladder paying particular attention to ensure that it is vertical and that the bumpers are pressed firmly against the inside wall.

Mark the positions for drilling. Remove the ladder and drill.

Fix the ladder in position using stainless steel bolts, do not forget to mount the counter plate under the coping. Tighten moderately.

Slide the 2 rubber seals along the tubes so that they hold the escutcheon plates in position.

13.2 Wooden access ladder



The ladder side rails and treads are enclosed in the wood kit. Assemble the ladder using SS screws from bag K). For a cleaner, easier assembly, pre-drill the 4 mm diameter holes and chamfer the edges to prevent splitting the wood or raising splinters.



The wooden ladder is equipped with two latches to lock it into position. The lever components are fastened to the ladder supports and the hooks are attached to the underside of the coping (the latch parts are enclosed in bag K). Observe the workings of the latch to understand how it works and how it locks the ladder in position.

Put the assembled ladder in position under the coping. Insert the blocks between the ladder rails and the coping. Make sure that the latch parts are correctly aligned. Mark the position of the various components. Remove the ladder and mount the latch components. Put the ladder back in position and make sure that the locking mechanism is working properly.

The fastening mechanism may differ from that illustrated but will function according to the same principle.



For the safety of your children, do not forget to fix the safety notice to the wall of the pool, stating that the ladder must be removed while the pool is not in use or is unsupervised.

The maximum weight that can be borne by the ladder is 150 Kg.

14. COMMISSIONING AND OPERATING RECOMMENDATIONS

- The pump power supply must be protected by a 30 mA differential circuit breaker mounted from the installation and so connected to the control panel provided (refer to the installation instructions).
- As a safety measure, the filtration system should be stopped while the pool is in use
- For further information, refer to the manual enclosed with the sand filter
- The pump should never be allowed to run dry (without water).
- The pool is designed for users 3 years of age and older. Children you do not know how to swim and who are not accompanied by a responsible adult must wear a flotation aid.
- No diving.
- Do not walk on the coping.
- Do not leave a pool empty and unsecured.
- Ladders should only be used to enter and leave the pool. They should not be used for any other purpose that could be dangerous.
- Wire the pump in, connect it to the electrical box (refer to the wiring diagrams enclosed with the electrical panel and the pump).

14.1 Recommendations and advice

▶ CAUTION Carry out a back wash and rinse before using the filter for the first time to clean the filter and remove any excess sand and impurities (see the paragraph Filter and Valve operation). After the back wash, rinse before turning the valve to the Filtration position. After the back wash, with the multi-port valve set to Filtration, the black needle on the pressure gauge indicates the nominal pressure experienced by the filter. This pressure will vary as a function of the pump flow rate, the static pressure and load losses across the pipes. To keep a record of this nominal pressure (calibration), adjust the dial of the pressure gauge so that the blue needle aligns with the black needle.

▶ IMPORTANT Stop the pump before each manipulation of the 6-way valve. Failure to respect this instruction could result in damage to the insides of the filter, the valve or the filter itself and will result in cancellation of the guarantee.

- Before starting the pump, make sure that all the 1/4 turn valves are open and that the 6-way valve is set to "Filtration".

14.2 Filter and valve operation

- **FILTRATION:** Water arrives from the pump, passes from the top to the bottom of the filter and is returned to the pool.
- **BACK WASH:** Water passes through the filter from the bottom to the top gathering trapped impurities and carrying them directly to waste. A back wash should be carried out as soon as the needle in the pressure gauge enters the red zone.
- **RINSE:** Water passes through the filter from top to bottom before being directed to waste (allow approximately 30 sec for this process.), next turn the valve to the filtration position (drain polluted water that remains in the pipes).
- **CIRCULATION :** Water circulates without passing through the filter.
- **DRAIN:** Water passes from the pool to waste (flocculation, etc.).
- **CLOSED:** No water circulation. Never allow the pump to run while the valve is in this position. Similarly, make sure that the position of the various valves will allow circulation of water before turning the pump on.

14.3 Length of the filtration cycle

The length of the filtration cycle depends on the theoretical time taken for all the water in the pool to pass through the filter. For private pools, the maximum time allowed for all the water to be recycled is 8 hours.

We recommend the following as a function of water temperature:

- Below 14°C : 5 to 6 hours per day.
- From 15° to 23 °C : 6 to 8 hours per day.

- Above 23 °C : 10 to 12 hours per day.

The higher the bather load and the pool water temperature, the longer the filtration cycle should be. To optimise filtration efficiency, run the filter during the day (between 8:00 am and 9:00 pm) and, more generally, while the pool is in use (one bather pollutes 3 m³ of water).

14.4 Cleaning the pre-filter and filter back wash

After a certain time, a drop in the flow rate at the return fittings will be noted. This is due to progressive clogging of the filter or pump pre-filter.

14.4.1 Pre-filter

If the pressure indicated on the pressure gauge falls below the nominal pressure indicated by the blue needle, clean the pump pre-filter:

- Stop the pump.
- Turn the 6-way valve to CLOSED.
- Close the suction and return valves.
- Open the pump pre-filter.
- Remove the basket.
- Use a water jet to remove any impurities.
- Put the pre-filter basket back.
- Put the pre-filter lid back on making sure that the seal is correctly positioned and that there is enough water to prime the pump.
- Move the 6-way valve to FILTRATION.
- Open the suction and return valves.
- Switch the pump on.
- Vent the filter (this should be done each time the pre-filter is cleaned and at least once a week).

14.4.2 Filter

If the pressure indicated by the pressure gauge rise above the nominal pressure, carry out a filter back wash.

- Stop the pump.
- Check the pre-filter and clean it out if necessary (as indicated above).
- Before proceeding with a filter back wash or draining the pool, make sure that the waste pipe (not provided) has been attached to the waste outlet.
- Put the 6-way valve to BACK WASH.
- Turn the pump on.
- Observe the colour of the water in the turbidity sight glass.

 **CAUTION** A few seconds will elapse before cleaning begins (water becomes cloudy).

- As soon as the water runs clear, stop the pump.
- Put the 6-way valve to RINSE.
- Switch the pump on for 20 to 30 seconds, to remove impurities and settle the sand.
- Stop the pump.
- Turn the 6-way valve to FILTRATION
- Switch the pump on.

After a back wash, the pressure in the filter should drop back down to the nominal pressure.

15. POOL OPERATION AND MAINTENANCE

Wood is a living material that responds to changes in temperature and humidity; cracks and splits may appear; this is natural and in no way impacts the service life of our products.

The wooden components of this pool are subjected to an autoclave treatment that complies with standards in effect, it presents no danger to people or animals that may come into direct contact with the wood.

Under no circumstances should any product (wood stain, micro-porous products, etc.) be applied to the wood.

Over time, the wood will inevitably get dirty. Clean it once a year with a high pressure jet to remove dirt trapped in the pores of the wood.

Take care to regulate the water pressure to avoid damaging the finish or raising wood fibres.

Inspect the wooden structure regularly (notably the coping and wooden access ladder) in order to remove any splinters that may have been raised.

This pool, that features self-supporting walls, is delivered as a kit and is not designed to be dismantled.

This pool is designed to be used by persons 3 years of age and older. It is understood that young children and non-swimmers using the pool will wear flotation devices. For your safety and that of your children, we recommend that you read and apply the safety recommendations..

Use of a pool kit implies adherence to safety recommendations outlined in the maintenance and operating instructions.

- octo 530 model, the bather load is limited to 5 people.
- octo+640 model, the bather load is limited to 6 people.
- octo+840 model, the bather load is limited to 8 people.

Ladders should only be used to enter and exit the pool. Any other use is prohibited and could be dangerous.

The wooden access ladder should be taken away and stored systematically after the last person leaves the pool. This is to prevent the risk of drowning. Store the ladder in a dry place during the winter. There should be no means of access to the pool while it is not in use. The ladder wood should be treated in the same way as the other wooden elements.

We recommend that you secure access to the finished pool with one of the measures set out in the French pool safety standard NF P 90-306, 307, 308 & 309 that is: Safety barrier - Alarm - Safety cover - Shelter.

Inspect the accessible nuts and bolts regularly and carry out any maintenance required (retighten, treat traces of rust, etc.).

Take care with the liner of your pool, do not treat it roughly as this could cause leaks. Make sure that correct tension is maintained on the liner, failure to do so could result in tears and leaks. See the guarantee conditions at the end of this manual.

During the life of your pool it may be necessary to empty it completely. In this event, take every precaution necessary to avoid accidents and danger (falls, etc.). Avoid leaving the pool empty for more than 48 hours, this could result in deformation of the structure.

Failure to abide by maintenance instructions may entail serious risks to health and safety, notably of children.

 **IMPORTANT** No diving - Do not walk on the coping - Never leave an empty pool unprotected.

15.1 Water treatment & maintenance of the filtration system

To ensure the comfort of pool users, you will need to treat the pool water. Follow the recommendations concerning operation of the filtration group: commissioning, frequency of use for regeneration of the water, maintenance, inspections (pipes, nuts and bolts), etc. Monitor the build up of dirt in the sand filter (see the section on filter back washing). Similarly, check that the filter openings are not blocked.

- Filtration should be stopped before any maintenance interventions on the filtration system.
- Filtration should be stopped before performing any maintenance on the filtration system.
- Access to the pool should be prevented in the event of a malfunction of any component of the filtration system.
- Any damaged or worn elements should be replaced immediately.
- Only use parts approved by our after-sales service.

During the pool season, the filter should be run every day for long enough to renew the entire pool water volume at least three times every 24 hours.

To ensure optimal efficiency of the filtration system, make sure that the water level remains correct and constant. The water level should be 2/3 of the way up the skimmer mouth.

To fill your pool, use tap water, its pH is close to the ideal pH. If you use water from a well or some other private source you must have it tested beforehand.

You will need to test the pH of your pool at regular intervals and adjust it if necessary to keep it between 7.0 and 7.4. The necessary treatment chemicals are widely available.

To preserve the quality of the pool water, it will need to be tested and treated regularly. Frequency will depend on a number of conditions; pool situation, bather load, weather conditions, etc. You should inform yourself regarding the use of the chemicals you may need to treat your pool and maintain good water quality.

As regards the disposal of waste water (when the pool is drained the filter is back washed), check the regulations in effect in the area where the pool is installed.

FAILURE TO RESPECT THE MAINTENANCE RECOMMENDATIONS MAY ENTAIL SERIOUS RISKS TO HEALTH, NOTABLY THAT OF CHILDREN.

15.2 Accessories

Electrical accessories equipping the pool; underwater lights, luminous bollards, water features or any other equipment item, must be wired in according to the standards in effect in the country of installation. We recommend extreme caution in this regard, and that you call in specialists.

To keep the water warm while the pool is not in use, some models are equipped with a bubble cover that can use the sun light to warm the pool water. It is very easy to use: simply deploy it over the pool while it is not in use. While the cover is not needed, turn it over to dry it and then roll it up and store it. Do not fold a bubble cover, this could cause it to tear. Wipe it down from time to time with a damp cloth. A bubble cover will in no way secure your pool. A winterizing safety cover is available as an option to secure your pool (compliant with the French safety standard NF P 90-308). This high quality product is hard wearing, resilient with an excellent finish. It should be maintained and stored similarly to the bubble cover.

15.3 Winterizing the pool

- Carry out a prolonged back wash of the filter.
- The pool should not be emptied during winter (or prolonged periods while the pool is not use). The liquid mass plays a several roles, providing thermal insulation, holding the liner and pool structure in position.
- Lower the water level to about 10 cm below the bottom of the skimmer mouth.
- Water can be siphoned from the pool or allowed to drain by gravity by moving the multi-port valve

to DRAIN. Water will run through the waste line. Do not run the pump during this operation.

- Next, disconnect the pipe underneath the skimmer so that it can act as an overflow in the event the water level rises due to precipitation. Remove any water treatment chemicals from the skimmer (chlorine tablets, flocculents, etc.).
- Unscrew the return fitting face ring from inside the pool.
- Use a threaded winterizing plug or rubber plug (not provided) to block the return fitting from inside the pool.
- Add an algicide and a winterizing product (not supplied) to the water.
- Remove the stainless steel ladder.
- Place a winter cover over the surface of the pool (If the pool is fitted with one).

 **NOTE** Winterizing is not mandatory, particularly in clement climates where temperatures remain positive year round. In this case, keep the water at the correct level and run the filter for 2 to 3 hours per day. Check the water level in the pool regularly.

15.3.1 Winterizing the hydraulic installation

- Disconnect the return line.
- Allow water to drain from the suction and return lines.
- Open the plug at the bottom of the filter and allow water to drain away. Do not replace the plug before putting the filter back into service.
- Open the drain plugs on the pump and pre-filter.
- Leave the plugs open.
- Cut the power supply to the filtration control panel.
- In as far as possible, store the filtration group in a location protected from humidity.
- In the case of an unprotected outdoor installation, remove the pump and store it.
- We think that we have provided you with main information you required to use and maintain your pool, however you will find more information in specialised guides and reviews. Don't hesitate to consult these.

15.4 Hygiene

There are no official regulations governing the hygiene of private pools. Despite this, to ensure the health of people using the pool, some rules should be respected!

This begins with good personal hygiene.

Then, to ensure that the water stays clean and clear, follow the instructions provided in the paragraph "Pool operation and maintenance". Pay particular attention to treatment cycles, water testing, filtration and pool cleaning. You are responsible for the equilibrium of your pool water.

Do not hesitate to inform yourself and seek the advice of professionals.

16. DO NOT PLAY WITH SAFETY !!!

Memorise safety numbers and display them close to the pool.

- Fire brigade: 18 in France
- Emergency services: 112 in Europe
- Poison control centre (enter the number of the centre closest to you) _____

In this fun environment you need to watch your children! You alone are responsible for their safety ! Children should be closely supervised at all times. The risk is at its greatest when children are less than 5 years old.

- Accidents don't just happen to others. Be ready to act!!
- Never leave a child alone close to the pool.
- Children should be closely supervised at all times.
- Children who don't know how to swim, or children not supervised by adults, should wear a flotation device (vest or arm bands). Without these precautions, access to the pool should be strictly denied.
- The access ladder must be removed while the pool is not in use irrespective of the length of time for which the pool will not be used (winterizing).
- Designate one person responsible for watching non-swimmers and children.
- Be particularly attentive when there are several people in the pool.
- Keep a pole and/or life ring close to the pool in case of necessity.
- Teach young children how to swim as early as possible!
- Before getting into the pool, wet the back of the neck, legs and arms to prevent irreversible thermal shock! This warning also applies to older pool users who frequently disregard this safety tip.
- Jumping or diving should be prohibited. The same applies to violent games.
- Do not stand or walk on the coping! No diving.
- Be careful not to leave toys in or around an unwatched pool, these could attract children.
- Keep the water clean and sanitary during the pool season.
- Water treatment chemicals should be kept out of reach of children; store them in a safe, inaccessible place. Never leave cleaning accessories near the pool.

▶ **NOTE** some equipment can contribute to safety:

- A safety barrier with a gate that is kept closed at all times (for example, a hedge would not be considered a safety barrier).
- A manually deployed, or automatic safety cover correctly installed and fastened in place.
- An electronic sensor that detects falls into the pool that is operational and active.

▶ **NOTE** Safety equipment does not replace the need for close supervision.

- Outside the pool season, the pool should be covered with a winter cover correctly positioned and attached. This serves an additional function in that it renders the pool less attractive.
- Make sure that there is a telephone (land line or mobile) within easy reach of the pool to avoid leaving children alone in the event of a problem.
- Learn first aid , especially child first aid, so that you are in a position to provide assistance in the event of an accident.
- Take steps to prevent access to the pool if the filtration system is damaged and during maintenance operations.

In the event of an accident::

- Get the child out of the water as quickly as possible.
- Call for help immediately and follow the advice given.
- Remove the wet clothes and wrap the child in warm blankets..

▶ **IMPORTANT** Memorise emergency numbers (fire brigade, ambulance, poison control centre) and display these close to the pool.

17. GUARANTEES

17.1 Wooden elements

Wooden components: 10 year guarantee from the manufacturer against insect infestation and rotting (wood is high pressure autoclaved in accordance with the standards in effect).

This guarantee does not cover natural warping of the wood (appearance of cracks, splits that in no way impact the mechanical strength of the wood) or changes in colour attributable to weathering. Defects resulting from errors in mounting or storage are also excluded from the scope of this guarantee: deformed wall slats (exposure to sunlight, assembly deferred after opening the package), slats altered or broken due to assembly in a manner other than that set out in the installation instructions.

Given the continuous pressure exerted by the water, the pool walls may become slightly curved over time.

This phenomenon, which is a result of the natural elasticity of wood, will stabilise by itself over time and will not lead to failure or breaking of the wooden slats.

This is not a defect, and will not be considered grounds for a guarantee claim.

Furthermore, application of a product such as wood stain will result in cancellation of the guarantee.

17.2 Accessories

The various accessories comprising your pool are guaranteed against manufacturing and assembly defects that could prevent proper usage of your pool. The guarantee conditions set out certain periodic checks and maintenance operations required to ensure proper operation of the pool. To avail yourself of the guarantee, these conditions must have been respected.

This guarantee does not cover the risk of corrosion that may occur over time or improper handling during assembly or improper use of accessories (impacts, scratches, etc. that can effect the various surface finishes) or incidents not in line with normal use of the pool and its accessories. Guarantees cover parts recognised as defective by our services and are limited to the replaced of the element or elements in question.

The costs of dismantling and reassembly, if any, are not covered.

Given the constant pressure exerted by the water, the pool walls may bend slightly over time.

This phenomenon, due to the natural elasticity of wood, will stabilise by itself over time and will not lead to the failure or breaking of the wood slats. It is not recognised as a defect and will not be accepted as grounds for a guarantee claim.

Guarantee conditions: accessories & optional equipment.

Article	Subject and scope of the guarantee	Term of the guarantee as of the date of purchase	Conditions governing acceptance of a claim
Liner	Leaktightness of welds. The guarantee is limited to replacement or repair of the liner recognised as defective without any other damages or interest.	2 years against leaks 2 years against stains	Adherence to conditions governing fitting, use and maintenance.

The following problems, associated with inappropriate use or maintenance of the membrane, are not covered in the scope of the guarantee:

- Folds that appear after the liner has been fitted, these can be caused by sliding of the membrane on loose soil or an uneven surface, or physico-chemical properties of the pool water that are outside the acceptable ranges: water temperature should be less than 28°C, pH should be between 7.0 and 7.4 if the pool water is treated with Chlorine, and between 7.4 and 8.0 if the pool is treated with Bromine. The concentration of the sterilising agent should be within the range recommended by the manufacturer of the water treatment products. If, despite following all the installation instructions and recommendations, creases or folds are present, contact your after sales service immediately.
- The appearance of yellow stains or discolouration along the water line. These may be the result of deposition of organic compounds floating on the water surface (sun creams and oils, residue of hydrocarbon combustion or smoke from wood fires). To prevent this from happening, clean the water line regularly using products designed for this purpose (not supplied) and a nonabrasive sponge.
- Very hard water can also be the cause of this type discolouration due to the build up of calcium deposits on the membrane. Hard water (TH greater than 225 ppm - information available from your water supplier) should be treated with a product to eliminate calcium and suitable for use in pools (not supplied).
- Stains caused by the growth of algae and micro-organisms: the pool water should be treated regularly with an appropriate dose of algacide.
- Stains, discolouration and wrinkles caused by direct contact with oxidizing agents (thrown directly into the pool) or pockets of excessively high concentrations of oxidising agents (frequently associated with failure to run filtration during the dissolution phase of the oxidising agents).
- Stains caused by stagnation and/or decomposition of a foreign body in direct contact with the liner (dead leaves, oxidizable metallic objects, miscellaneous detritus, etc.).
- Damage caused by direct contact with incompatible materials such as bitumen, tar, oils, polystyrene panels, polyurethane. Never apply adhesive tape or glue to the membrane.
- Tears that occur while fitting the liner caused by shifting the liner without releasing it from the liner locking track first.

Article	Subject and scope of the guarantee	Term of the guarantee as of the date of purchase	Conditions governing acceptance of a claim
Pool fittings	Leaktightness and durability of the pool fittings	10 years	
Filters + connections	Leaktightness of the filter tank Leaktightness of the preassembled connection elements (rigid descending pipes)	5 years on the filter tank	The hydraulic installation, and notably the pump, should generate an operating pressure less than 1.2 bar. Regular back washes to clean the filter to avoid clumping of the filter medium.

The following problems, associated with inappropriate use of the pump, are not covered under the terms of this guarantee:

- Leaks caused by running the filter at an operating pressure greater than 1.2 bar (use of a pump that is too powerful, clogged filter medium, etc.), or installing the filter above the water level without a vent and check valve. (see the installation instructions)
- “Stress-cracking “ of ABS parts (valve, nuts) caused by surface reactants found in some types of

grease: grease should not be used on these types of components.

- The continuous expulsion of sand if sand with a grain size of less than 0.6 mm is used (the sand supplied has the correct grain size).

Article	Subject and scope of the guarantee	Term of the guarantee as of the date of purchase	Conditions governing acceptance of a claim
Pump	Motor operation Operation and leaktightness of the hydraulic components	2 years	See below + regular cleaning of the pre-filter.

The following problems, associated with inappropriate use of the pump, are not covered under the terms of this guarantee:

- Running the pump “dry” (absence of water, clogging of the pre-filter)
- Running the pump without the pre-filter

Article	Subject and scope of the guarantee	Term of the guarantee as of the date of purchase	Conditions governing acceptance of a claim
S u m m e r cover	Fit for purpose	2 years	

! TIP When the cover is not deployed over the pool, it should be dried, rolled up and stored protected from sunlight.

! TIP To avoid ripping out the eyelets, do not subject them to excessive strain .

Monitor the water quality during the time that the cover is deployed over the pool. Pool chemical concentrations that are too high, or a pH that is too low or too high, could cause discolouration or damage to the cover.

To avoid the growth of mould on the cover while it is not in use, make sure to dry it carefully before storing it.

Article	Subject and scope of the guarantee	Term of the guarantee as of the date of purchase	Conditions governing acceptance of a claim
Maintenance accessories	Fit for purpose	2 years	

18. APPENDICES - POOL EXPLODED VIEWS

18.1 Exploded view - OCTO pool

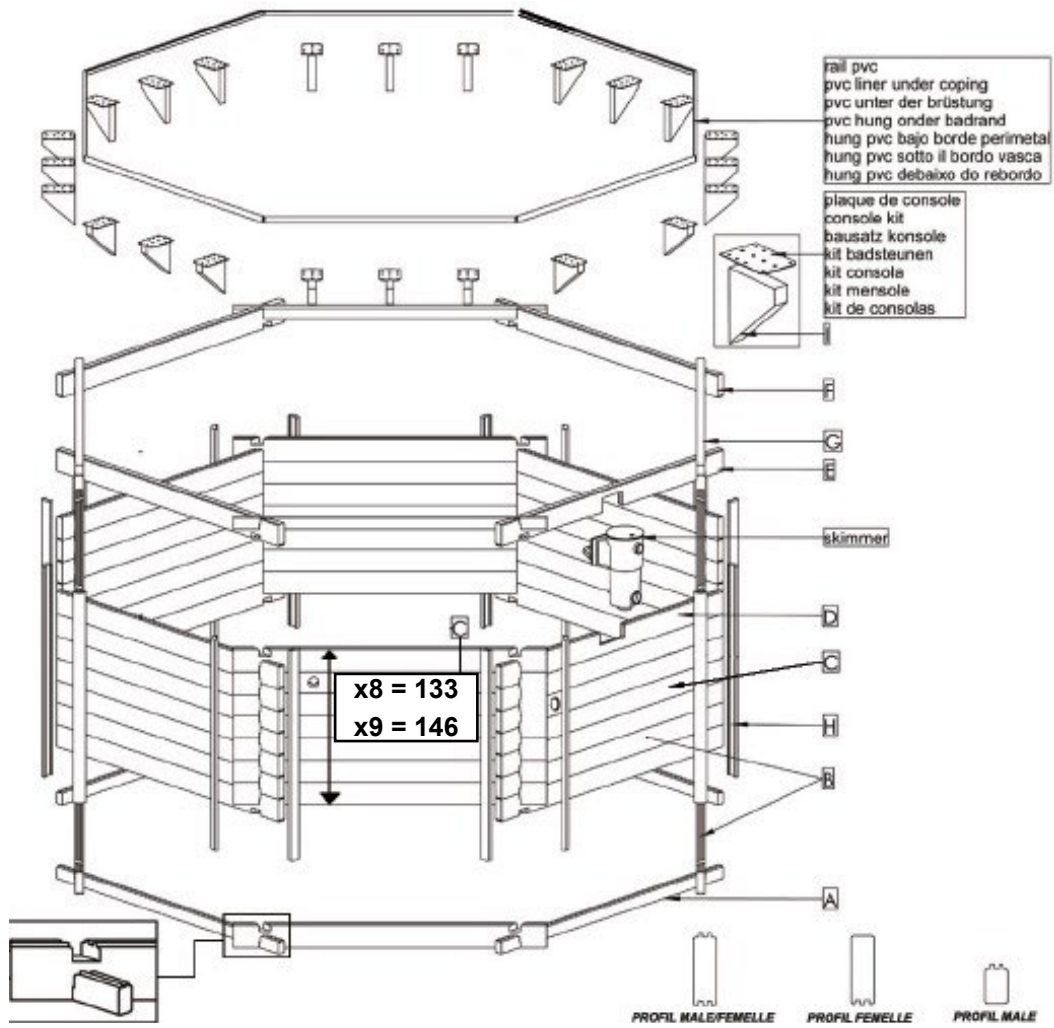

18.2 Exploded view - OCTO+ pools

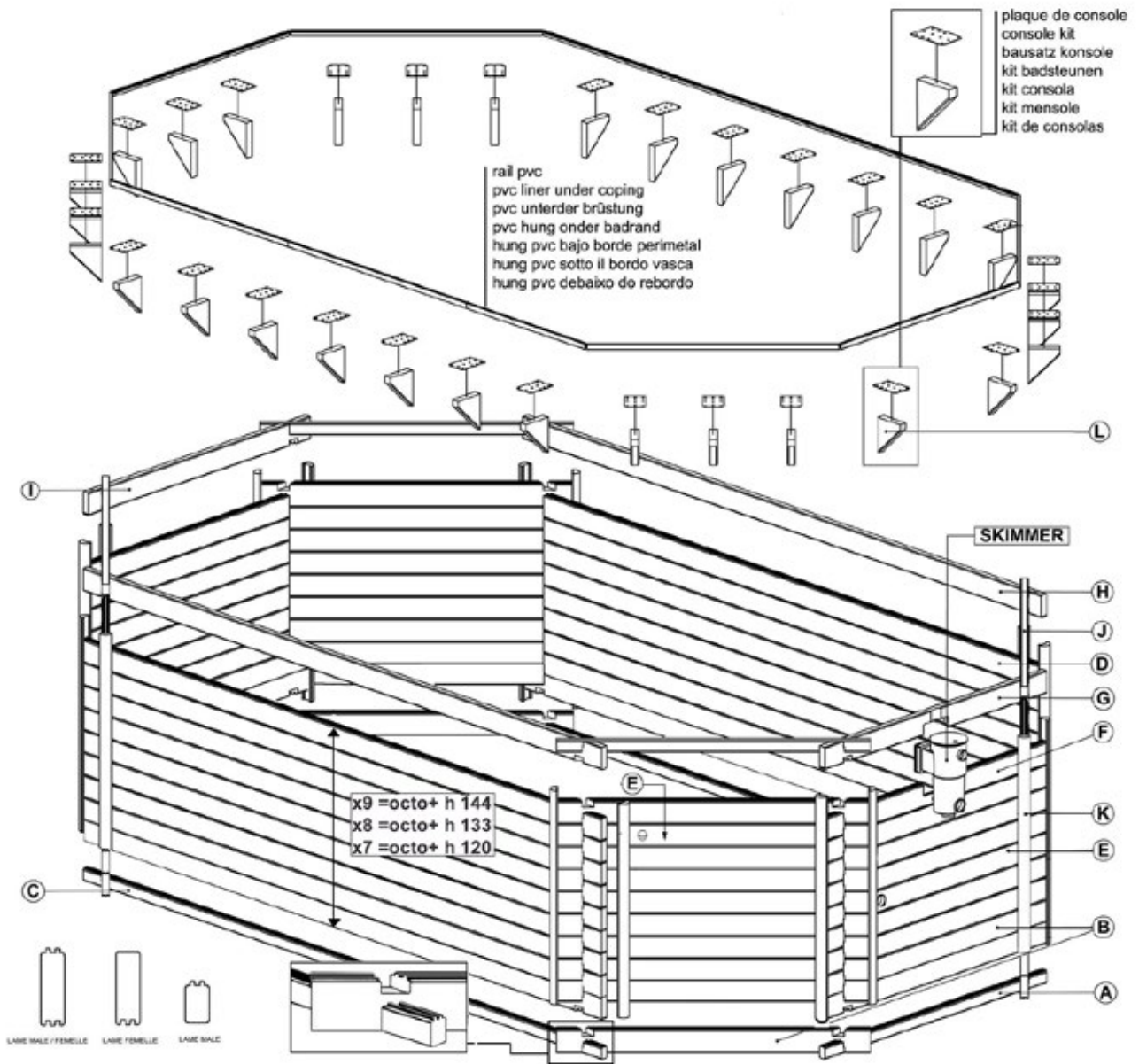

Notes

A series of horizontal dotted lines for taking notes, starting from the top right of the 'Notes' header and extending across the page.



ATTESTATION DE CERTIFICATION

CERTIFICATE OF

CHAINE DE CONTRÔLE PEFC CHAIN OF CUSTODY PEFC CERTIFICATION

Société / Company : PROCOPI
35137 PLEUMELEUC
N° Chaîne de contrôle : FCBA/12-01382
Chain of Custody N°

Produits Products Categories	Domaine d'application Scope	Méthode utilisée Method	Origine des matières premières Raw materials origin
09010 - Constructions et leurs éléments Buildings and their parts	Fabricant d'aménagements extérieur en bois Wooden outdoor accomodations manufacturing	Transfert en pourcentage moyen Average percentage method	Certifiée Certified

La chaîne de contrôle de l'entreprise ci-dessus désignée est en conformité avec les exigences PEFC* en vigueur.

The chain of custody of the company appointed above is in compliance with the requirements PEFC in force.

Ce certificat est délivré selon le règlement de gestion de chaîne de contrôle PEFC de FCBA en vigueur.

This certificate is delivered according to the FCBA requirements for the PEFC chain of custody

* standards PEFC/FR ST 2002 : 2013 et PEFC/FR ST 2001 :2008 du schéma français de certification forestière 2017-2022, traduction des standards PEFC ST 2002 : 2013 et PEFC ST 2001 :2008 du document technique de PEFC C

Ce certificat atteste la vérification de la chaîne de contrôle PEFC, fondée sur un contrôle permanent. Il ne peut préjuger d'évolutions ou de décisions qui seraient prises en cours d'année. La liste des entreprises sous certification est disponible sur les sites Internet : www.fcba.fr et www.pefc.org.

This document testifies the certification of PEFC chain of custody, based on a permanent assessment. There can not be any evolution or decision which would be taken in the course of the year after examination of the results of the audits of follow-up. This document is the property of FCBA. In case of the mark's withdrawal, the original and all the copies must have returned to FCBA.



Siège Social
10, rue Galilée
CS 81050 Champs sur Mame
77447 Mame la Vallée Cedex 2
www.fcba.fr

Numéro de Certificat : 00010258

Certificate Nr :

Annule et remplace N°

Cancel and replace :

Date d'émission : 02/02/2022

Issued :

Valable jusqu'au : 01/02/2027

Valid until :

Nombre de pages /

Pages : 1

LE DÉCIDEUR
TECHNIQUE

Jérôme MONTEFERRARIO

LE DIRECTEUR
CERTIFICATION

Alain HOCQUET

Numéro de série

